

COMMERCIAL  
PRODUCT CATALOG 1/11  
[WWW.METRO.COM](http://WWW.METRO.COM)



Products designed to fit  
your business and your needs.



# Advantage

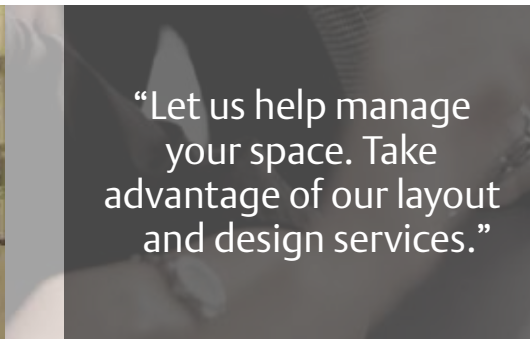

“Let us help manage your space. Take advantage of our layout and design services.”

*Examples of 3D Product and Application Visualization*

Looking for value-added services?

Metro can make everything from application visualization to custom packaging easy.

## Professional Services Available:

- Free “Space Audits” to Optimize Your Storage
- Product Planning and Room Layout
- Project Quoting and Management
- 3D Product and Application Visualization
- Custom Product Design and Engineering
- Product Prototyping and Samples
- Custom Packaging



# Metro.



“We take pride in delivering a positive purchasing experience.”

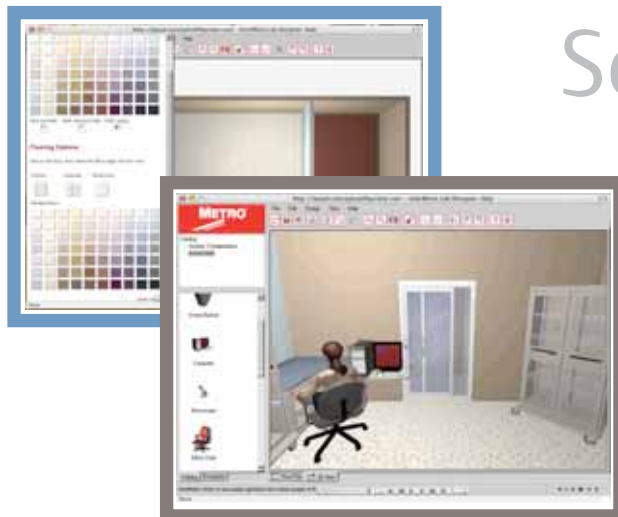

## Self-Service Tools ...online!

- Web-Based Room Layout and Product Planning
- Web-Based Product Configuration
- Web-Based Learning Modules

Visit [www.metroconfigurator.com](http://www.metroconfigurator.com) and test drive the Configurator . . . our web-based software developed to give you the power to manage your space.



# CONTENTS

Value Added Services ..... Inside Front Cover-3  
 Table of Contents..... 4-5  
 Metro Shelving Systems ..... 6-7

## Polymer Shelving Solutions..... 8-28

iQ System Overview ..... 10-11  
 How MetroMax i® & MetroMax Q® Integrate ..... 12-13  
 Build-a-shelf with the iQ Shelving System ..... 14-15  
 Casters, Pull & Push Handles ..... 16-17  
 Mobile Shelving Units & Utility Carts ..... 18-19  
 Starter & Add-On Units..... 20-21  
 System Accessories ..... 22-28

## Wire and Solid Shelving Solutions ..... 30-69

Wire/Polymer Hybrid Shelving ..... 32-35  
 Easy-Adjust Shelving & Carts ..... 36-39  
 Wire Shelving, Carts & Trucks..... 40-47  
 Casters & Accessories for Wire Shelving ..... 48-62  
 Solid Shelving & Accessories ..... 64-66  
 Light-Duty Wire Shelving & Accessories ..... 67  
 Heavy-Duty Solid Shelving & Accessories ..... 68-69

## Wall Shelving & Carts..... 70-85

Wall Shelving & Storage Systems..... 72-80  
 Heavy-Duty Polymer Utility Carts..... 81  
 Polymer Utility Carts ..... 82-83  
 Utility Carts..... 84  
 Heavy-Duty Utility Carts ..... 85

## High-Density Storage, Dunnage & Security..... 86-105

High-Density Movable Aisle Shelving ..... 88-95  
 Vertical High-Density Shelving ..... 96  
 Dunnage Racks & Shelves ..... 97-98  
 Security Storage..... 99-103  
 Seismic Shelving ..... 104-105

# CONTENTS

## Municipal Services Products ..... 107-112

- Turn-out Gear/General Storage and Security ..... 110
- Sanitation & Electronic Charging Stations..... 111
- Evidence & Property Storage ..... 112

## Grocery & Retail Products ..... 114-140

- Display Shelving & Accessories ..... 117-129
- Specialty Shelving ..... 130-132
- Food Prep..... 133-136
- Inventory Storage & Transport..... 137-138
- Cooler/Freezer Storage..... 139-140

## Electronics & Clean Room Products ..... 142-163

- Carts, Covers & ESD Accessories ..... 144-149
- PCB Handling ..... 150-155
- Tote Boxes, Bins & Accessories..... 156-157
- Clean Tables, Carts & Gowning Room Products ..... 158-163

## Laboratory Products ..... 164-227

- Lab Carts & Storage ..... 166-180
- Autoclave Storage & Carts ..... 181-183
- LAR Feed Carts & Storage ..... 184-185
- Lab Worktables & Accessories ..... 186-194
- Mobile Computing WorkCenters ..... 195
- Portable Power Module/Units ..... 196-197
- Starsys Lab Furniture ..... 198-227

Terms and Conditions ..... 228-230

Index ..... Inside Back Cover

Locations ..... Back Cover



Superior materials and design for every application.

# Engineered for use and abuse.

Robust Steel Corners • Reinforced Center Supports  
 Durable Finishes • Advanced Polymer Materials • Type 304 Stainless Steel  
 Easy-to-Adjust in Increments of 1" (25mm)



	MetroMax i® Polymer	MetroMax Q® Polymer & Epoxy Coated Steel	Stainless Steel Solid/Wire	Super Erecta® Pro Epoxy Coated Wire and Polymer Shelving	Super Adjustable™ Wire Shelving Epoxy Coated/Plated	Super Erecta® Wire Shelving Epoxy Coated/Plated
Accessories	●	●	○	◐	●	●
Antimicrobial Protection	●	●	N/A	●	● / N/A	● / N/A
Autoclave Sterilization	●	●	●	●	●	●
Chemical Resistance to common cleaners / sanitizers	●	◐	●	◐	○	○
Corrosion Protection in wet / moist environments	●	◐	●	◐	○ / ●	○ / ●
Easily Cleanable	●	◐	◐ / ○	◐	○	○
High Temperature Cart Wash	○	●	●	●	●	●
Mobility	●	●	●	●	●	●
Quick to Adjust	◐	●	○	○	●	○
Strength	●	●	●	●	●	●

- Excellent
- ◐ Above Average
- Average
- Below Average
- Not Recommended
- N/A Not Applicable



\*MICROBAN® antimicrobial product protection helps keep shelves “cleaner between cleanings” by inhibiting the growth of mold, mildew, fungus, and bacteria that cause odors and stains on the shelf surface.  
 MICROBAN® and the MICROBAN® symbol are registered trademarks of the Microban Products Company, Huntersville, NC.

## MetroMax i®

“The ultimate storage and handling system with a lifetime guarantee against rust”



## MetroMax Q®

“Quick to Clean  
Quick to Adjust  
Quick to Assemble”



## Super Adjustable Super Erecta®

“The easiest to adjust wire shelving system ever”



## qwikSLOT™

“Add-A-Shelf,  
Remove-A-Shelf . . .  
Instantly”



## Super Erecta Pro™

“Durable and Cleanable.  
The original — reinnovated.”



## Super Erecta®

“The Original Wire Storage and Handling System”



## Drop Mat™

“Provides density and containment economically”



## Super Erecta® Solid

“A solid performer in the proven Super Erecta style”







# POLYMER SHELVING SOLUTIONS

- iQ System Overview ..... 10-11
- How MetroMax i® & MetroMax Q® Integrate ..... 12-13
- Build-a-shelf with the iQ Shelving System ..... 14-15
- Casters, Pull & Push Handles ..... 16-17
- Mobile Shelving Units & Utility Carts ..... 18-19
- Starter & Add-On Units ..... 20-21
- System Accessories ..... 22-28

# uniQ<sup>ue</sup> equation.

**i + Q = iQ** ... now that's smart.

## Uniquely Justifiable

*"Budgets are tight . . . so we need to make every dollar last."*

**MetroMax i<sup>®</sup>**  
Uniquely Lifelong . . .



## Uniquely Cleanable

*"Removable mats are a must in any industry, so cleanable."*

**MetroMax Q<sup>®</sup>**  
Unique Value . . .



## Uniquely Interchangeable

*"We're looking for a smart system that lets us interchange and upgrade components to meet new and changing tasks."*

## Uniquely Durable

*"We needed a system as strong as our Metro racks but with protected surfaces that won't scratch and chip. The polymer shelf mats and posts definitely hold up to all the abuse, plus the mats are really easy to clean."*

# MetroMax iQ® Storage System

**Interchangeability:** MetroMax i® and MetroMax Q® shelves, posts, and most accessories are uniquely interchangeable making the iQ system adaptable to your specific application.

**Longer-Life Durability and Performance:** Corrosion proof MetroMax i® has an innovative polymer design and the performance of stainless steel at a fraction of the cost. MetroMax Q® has an advanced polymer and epoxy coated steel design that offers superior performance versus wire shelving. All shelves hold as much weight as wire shelves, but also offer protective polymer surfaces for long life and easily removable shelf mats that can be cleaned in a fraction of the time of wire.

Designed with innovative polymers for longer-life product performance, easy-to-clean surfaces to promote a cleaner environment and higher level of safety, interchangeable components for maximum flexibility, interactive on-line tools . . . a truly unique way to improve operational efficiencies, productivity, and ultimately ROI.



**Improved Cleanability:** iQ System shelves have removable polymer mats that are easily cleaned in sinks, wash or dish machines. Cleaner shelves promote safe environments.

**Storage Optimization:** iQ System accessories contain, compartmentalize, and organize your stored contents to maximize every square inch of storage space. Smooth polymer components protect fragile packaged items.



We put space to work.™



## MetroMax i® Uniquely Lifelong ...

- Corrosion Proof, Lifetime Warranty Against Corrosion
- Polymer Construction with Stainless Steel Corners
- All Polymer Posts
- Removable, Easily Cleanable Polymer Shelf Mats
- Open Grid and Solid Shelves



### Interchangeable Posts



### Interchangeable Shelves



# Selecting system components for your



*“The choice was easy... Our facility needed the most cleanable, most durable, and totally corrosion proof system available, and MetroMax i® was all that and cost efficient.”*



*“We put extremely heavy loads on our MetroMax i Top-Track system, so we opted for the steel posts for added rigidity.”*



## MetroMax Q® Unique Value ...



- Quick-to-adjust Shelves Provide Maximum Space Utilization
- Corrosion Resistant, 15 Year Warranty Against Corrosion
- Epoxy Coated Wire Shelf Frames and Posts
- Removable, Easily Cleanable Polymer Shelf Mats
- Open Grid Shelves

### Strong.

All shelves are designed with robust steel corners and reinforced center trusses for the strength you need. Shelves up to 48" (1219mm) long hold 800 lbs. (363kg). A four-shelf unit can hold 2,000 lbs. (907kg).



All shelf mats, posts, and touch points have built in Microban® antimicrobial product protection.

\*MICROBAN® and the MICROBAN® symbol are registered trademarks of the Microban Products Company, Huntersville, NC.

application . . . it's a no brainer.



*"While outfitting a damp area with shelving, we were able to upgrade our system; all 4 posts are now polymer and the bottom shelf is a Heavy Duty polymer as well . . . the units fit perfectly into our budget and provides long-term value."*



*"We've typically purchased standard wire shelving, but these days value is a must. Upgrading to MetroMax Q is the perfect balance between price and value. It's easy to clean and resists rust and corrosion, for a longer shelf life."*



MetroMax i® Polymer Shelving — 9.20

Standard Shelves

- Part number includes shelf with removable mats and one bag of wedges.

Width (in.)	Nominal (mm)	Length (in.)	Nominal (mm)	Approx. Pkd. Wt.		Cat. No. Shelf with Grid Mat	Approx. Pkd. Wt.		Cat. No. Shelf with Solid Mat
				(lbs.)	(kg)		(lbs.)	(kg)	
18	457	24	610	8.7	4.0	<b>MX1824G</b>	12.7	5.8	<b>MX1824F</b>
18	457	30	760	10.5	4.7	<b>MX1830G</b>	14.5	6.6	<b>MX1830F</b>
18	457	36	914	12.2	5.5	<b>MX1836G</b>	17.2	7.8	<b>MX1836F</b>
18	457	42	1060	13.9	5.3	<b>MX1842G</b>	20.1	9.1	<b>MX1842F</b>
18	457	48	1220	15.7	7.1	<b>MX1848G</b>	23.1	10.5	<b>MX1848F</b>
18	457	54	1372	17.5	7.9	<b>MX1854G</b>	21.5	9.7	<b>MX1854F</b>
18	457	60	1524	19.2	8.7	<b>MX1860G</b>	23.2	10.5	<b>MX1860F</b>
18	457	72	1829	22.5	10.2	<b>MX1872G</b>	27.5	12.5	<b>MX1872F</b>
24	610	24	610	12.2	5.5	<b>MX2424G</b>	14.2	6.4	<b>MX2424F</b>
24	610	30	760	13.9	6.3	<b>MX2430G</b>	15.9	7.2	<b>MX2430F</b>
24	610	36	914	15.6	7.1	<b>MX2436G</b>	19.6	8.9	<b>MX2436F</b>
24	610	42	1060	17.5	7.9	<b>MX2442G</b>	21.5	9.8	<b>MX2442F</b>
24	610	48	1220	19.3	8.7	<b>MX2448G</b>	25.3	11.5	<b>MX2448F</b>
24	610	54	1372	21.0	9.5	<b>MX2454G</b>	25.0	11.3	<b>MX2454F</b>
24	610	60	1524	22.8	10.5	<b>MX2460G</b>	26.8	12.1	<b>MX2460F</b>
24	610	72	1829	26.0	11.8	<b>MX2472G</b>	31.0	14.1	<b>MX2472F</b>

Actual Dimensions: Width: Add 1/4" (6mm) to nominal size. Length: Subtract 1/4" (6mm) from nominal size.



Heavy-Duty Dunnage Shelves

- Weight capacity per shelf evenly distributed: 1,200 lbs. (544kg) on shelves up to and including 48" (1220mm) long; 900 lbs. (408kg) for shelves 60" (1524mm) long.

Width (in.)	Nominal (mm)	Length (in.)	Nominal (mm)	Approx. Pkd. Wt.		Cat. No. Shelf with Grid Mat	Approx. Pkd. Wt.		Cat. No. Shelf with Solid Mat
				(lbs.)	(kg)		(lbs.)	(kg)	
18	457	36	914	18	8.2	<b>MHP1836G</b>	22	10.0	<b>MHP1836F</b>
18	457	48	1220	22	10.0	<b>MHP1848G</b>	26	11.8	<b>MHP1848F</b>
18	457	60	1524	26	11.8	<b>MHP1860G</b>	30	13.6	<b>MHP1860F</b>
24	610	36	914	21	9.5	<b>MHP2436G</b>	25	11.3	<b>MHP2436F</b>
24	610	48	1220	27	12.2	<b>MHP2448G</b>	31	14.1	<b>MHP2448F</b>
24	610	60	1524	33	15.0	<b>MHP2460G</b>	37	16.8	<b>MHP2460F</b>

(Dunnage shelves are not recommended for use as part of an add-on unit with two posts.)



Polymer Posts

- Corrosion proof with built-in Microban antimicrobial product protection.
- Compatible for use with MetroMax i® and MetroMax Q shelves.
- Stationary posts include an adjustable leveling foot to compensate for uneven floors. Leveling foot can be adjusted 1" (25mm).



Nominal Height (in.)	(mm)	Approx. Pkd. Wt.		Cat. No. Stationary Post with Leveling Foot	Cat. No. Mobile Post for Stem Caster
		(lbs.)	(kg)		
9	228	0.3	0.15	—	<b>MX9UP</b>
13	370	0.5	0.2	<b>MX13P</b>	<b>MX13UP</b>
27	685	0.9	0.4	<b>MX27P</b>	<b>MX27UP</b>
33	875	1.0	0.5	<b>MX33P</b>	<b>MX33UP</b>
54	1370	1.6	0.7	<b>MX54P</b>	<b>MX54UP</b>
63	1585	1.8	0.8	<b>MX63P</b>	<b>MX63UP</b>
74	1890	2.2	1.0	<b>MX74P</b>	<b>MX74UP</b>
86	2195	3.0	1.4	<b>MX86P</b>	<b>MX86UP</b>

(Special height cut posts are available. Consult your Metro representative.)



MetroMax i® Replacement Wedges

Bag of (4)  
Cat. No. **MX9985**

MetroMax i® Wedges are not compatible with original MetroMax shelves and posts.



Post Clamp

Adds stability by joining posts of two separate units together. With it, each unit is supported by four posts and buttressed by the adjacent unit.  
Cat. No. **9994X**



Foot Plate

Use to add stability to the shelving unit or to bolt units to the floor.  
Cat. No. Zinc **9993Z**  
Cat. No. Stainless Steel **9993S**



Note: MetroMax i® shelves, posts, and wedges are not compatible with original MetroMax shelves and posts.

## MetroMax Q® Shelving — 9.21

### Standard Shelves

- Part number includes shelf with removable mats and one bag of wedges.

Width (in.)	Nominal (mm)	Length (in.) (mm)		Approx. Pkd. Wt. (lbs.) (kg)		Cat. No. Shelf with Cat. No.
18	457	24	610	6.2	2.8	<b>MQ1824G</b>
18	457	30	760	8.0	3.6	<b>MQ1830G</b>
18	457	36	914	9.7	4.4	<b>MQ1836G</b>
18	457	42	1060	11.4	5.2	<b>MQ1842G</b>
18	457	48	1220	13.2	6.0	<b>MQ1848G</b>
18	457	54	1372	15.0	6.8	<b>MQ1854G</b>
18	457	60	1524	16.7	7.6	<b>MQ1860G</b>
18	457	72	1829	20.0	9.1	<b>MQ1872G</b>
21	530	24	610	8.0	3.6	<b>MQ2124G</b>
21	530	30	760	9.7	4.4	<b>MQ2130G</b>
21	530	36	914	11.4	5.2	<b>MQ2136G</b>
21	530	42	1060	12.8	5.8	<b>MQ2142G</b>
21	530	48	1220	14.5	6.6	<b>MQ2148G</b>
21	530	54	1372	16.7	7.6	<b>MQ2154G</b>
21	530	60	1524	18.5	8.4	<b>MQ2160G</b>
21	530	72	1829	21.7	9.9	<b>MQ2172G</b>
24	610	24	610	9.7	4.4	<b>MQ2424G</b>
24	610	30	760	11.4	5.2	<b>MQ2430G</b>
24	610	36	914	13.1	6.0	<b>MQ2436G</b>
24	610	42	1060	14.1	6.4	<b>MQ2442G</b>
24	610	48	1220	15.8	7.1	<b>MQ2448G</b>
24	610	54	1372	18.5	8.4	<b>MQ2454G</b>
24	610	60	1524	20.3	9.2	<b>MQ2460G</b>
24	610	72	1829	23.5	10.7	<b>MQ2472G</b>

**Actual Dimensions:** Width: Add 3/8" (10mm) to nominal size.  
Length: Subtract 3/16" (5mm) from nominal size.



MetroMax Q® shelves that are part of the iQ system have different actual measurements than original MetroMax Q shelves and cannot be mixed on the same shelving units.



### Solid Mat Overlays

- Overlays snap onto the open grid mats to create a solid surface.
- Available for 21" (530mm) deep MetroMax Q shelves.
- For 18" (457mm) and 24" (610mm) deep solid shelves, please see Models MX\*\*\*\*F on previous page.

Fits Shelf (in.)	Fits Shelf (mm)	Approx. Pkd. Wt. (lbs.) (kg)		Cat. No.
21x24	530x610	0.35	0.16	<b>Q2124SM</b>
21x30	530x760	0.45	0.20	<b>Q2130SM</b>
21x36	530x914	0.50	0.23	<b>Q2136SM</b>
21x42	530x1060	0.60	0.27	<b>Q2142SM</b>
21x48	530x1220	0.70	0.32	<b>Q2148SM</b>
21x54	530x1372	0.80	0.36	<b>Q2154SM</b>
21x60	530x1524	0.90	0.41	<b>Q2160SM</b>
21x72	530x1829	1.00	0.45	<b>Q2172SM</b>



### Posts

- Epoxy coated steel and polymer posts have Microban antimicrobial product protection.
- Stationary posts include an adjustable leveling foot to compensate for uneven floors. Leveling foot can be adjusted 1" (25mm).
- When mounting a shelving unit to a dolly base, stationary posts are used.

Nominal Height (in.) (mm)	STEEL				POLYMER				
	Approx. Pkd. Wt. (lbs.) (kg)	Cat. No. Stationary Post with Leveling Foot	Cat. No. Mobile Post for Stem Caster	Approx. Pkd. Wt. (lbs.) (kg)	Cat. No. Stationary Post with Leveling Foot	Cat. No. Mobile Post for Stem Caster			
9	0.3	0.15	—	—	—	<b>MX9UP</b>			
13	1.0	0.5	<b>MQ13PE</b>	<b>MQ13UPE</b>	0.5	0.2	<b>MX13P</b>	<b>MX13UP</b>	
27	2.0	0.9	<b>MQ27PE</b>	<b>MQ27UPE</b>	0.9	0.4	<b>MX27P</b>	<b>MX27UP</b>	
33	2.5	1.1	<b>MQ33PE</b>	<b>MQ33UPE</b>	1.0	0.5	<b>MX33P</b>	<b>MX33UP</b>	
54	4.0	1.8	<b>MQ54PE</b>	<b>MQ54UPE</b>	1.6	0.7	<b>MX54P</b>	<b>MX54UP</b>	
63	4.5	2.0	<b>MQ63PE</b>	<b>MQ63UPE</b>	1.8	0.8	<b>MX63P</b>	<b>MX63UP</b>	
70	1778	5.0	2.3	—	<b>MQ70UPE</b>	—	—	—	
74	1890	5.5	2.5	<b>MQ74PE</b>	<b>MQ74UPE</b>	2.2	1.0	<b>MX74P</b>	<b>MX74UP</b>
86	2195	6.5	2.9	<b>MQ86PE</b>	<b>MQ86UPE</b>	3.0	1.4	<b>MX86P</b>	<b>MX86UP</b>

(Special height cut posts are available. Consult your Metro representative.)



MetroMax Q® Replacement Wedges  
Bag of (4)  
Cat. No. **MQ9985**



MetroMax Q® Wedges are compatible with original MetroMax Q shelves and posts.

# Go mobile.

Add casters to any shelving unit to add versatility.

## MetroMax iQ Stem Casters — 9.25

For use with either MetroMax i polymer or MetroMax Q steel stem caster posts.

- Promotes easy cleaning. Casters allow shelving units to be moved easily for access to floors and walls.
- Efficient Transport: Create a cart to efficiently move supplies throughout a facility or campus.



5PCX

## Polymer Stem Casters — 9.25

- Corrosion resistant performance: all-polymer horn, stainless steel axel and hardware, 5" (127mm) diameter polyurethane wheel, sleeve-style axle bearing, and an optional toe-operated brake mechanism.
- Models available with antimicrobial product protection built into the tread.
- Load rating of 300 lbs. (135kg) and a temperature range from -20° to 120° F (-29° to 49° C) [continuous].
- Bumpers included.



5PCBX

Wheel Tread	Type	Diameter (in.)	(mm)	Width (in.)	(mm)	Approx. Pkd. Wt. (lbs.)	(kg)	Cat. No.	Cat. No. Antimicrobial
Polyurethane	Swivel	5	127	1 1/4	32	2	.9	5PCX	5PCXM
Polyurethane	Brake	5	127	1 1/4	32	2	.9	5PCBX	5PCBXM
Polyurethane	Rigid*	5	127	1 1/4	32	2	.9	5PCRX	

**Note 1:** Optional tread guards (blue) may be ordered by adding "-TG" to the desired model number (eg. 5PC-TG, 5PCB-TG, 5PCR-TG).  
**Note 2:** Stem casters are shipped with donut bumpers at no extra charge.  
**\*Note 3:** Rigid casters are held in place by a connecting channel. When ordering, shelf width **must** be provided.  
**Note 4:** Not suitable for cart wash and autoclave applications.



5MPX

## Standard Stem Casters — 9.25

- Plated caster horns and hardware.
- Swivel, Swivel with Brakes, and Rigid Caster options available.

Type	Wheel Tread	Load Rating (lbs.)	(kg)	Approx. Pkd. Wt. (lbs.)	(kg)	Cat. No.
Stem/Swivel	Resilient	200	91	2 3/4	1.2	5MX
Stem/Brake	Resilient	200	91	3	1.4	5MBX
Stem/Rigid	Resilient	200	91	3 3/4	1.7	5MRX
Stem/Swivel	Polyurethane	300	135	2 1/4	1.0	5MPX
Stem/Brake	Polyurethane	300	135	2 1/2	1.1	5MPBX
Stem/Rigid	Polyurethane	300	135	2 1/4	1.0	5MPRX
Stem/Swivel	Resilient Donut	250	113	2 1/2	1.1	5MDXA
Stem/Brake	Resilient Donut	250	113	2 1/2	1.1	5MDBXA
Stem/Rigid	Resilient Donut	250	113	2 1/2	1.1	5MDRXA

MetroMax iQ bumpers included.  
**\*Note:** Rigid casters are held in place by a connecting channel. When ordering, shelf width **must** be provided.

Rigid stem casters are often ordered two per unit for improved tracking and handling. Rigid caster channels are provided with each two rigid stem casters at no charge.

## Stainless Steel Cart-Washable Stem Casters — 9.25

- Stainless horn, axle, and stem with sealed bearings.

Type	Wheel Tread	Load Rating (lbs.)	(kg)	Approx. Pkd. Wt. (lbs.)	(kg)	Cat. No.
Stem/Swivel	Polyurethane	300	135	2 1/8	1.0	5MPXGSA
Stem/Brake	Polyurethane	300	135	2 1/8	1.0	5MPBXGSA
Stem/Rigid*	Polyurethane	300	135	2 1/8	1.0	5MPRXGSA

**\*Note:** Rigid casters are held in place by a connecting channel. When ordering, shelf width **must** be provided.



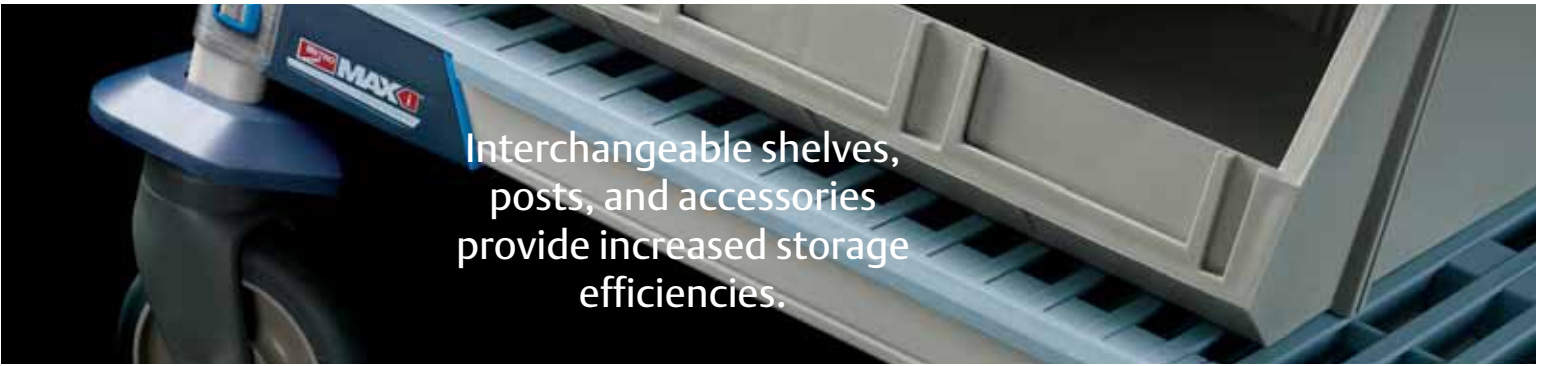

Interchangeable shelves, posts, and accessories provide increased storage efficiencies.

# Handle it.

Adding Stainless Steel handles to shelving puts you in control.

- Use handles on mobile units to improve maneuverability and ergonomics.
- Handles are compatible with MetroMax i® and MetroMax Q® units.
- Corrosion proof Type 304 stainless steel construction offers long lasting performance.



Tri-Lobal Adapters  
Included with handles.

Tri-Lobal Adapter  
Replacements  
Cat. No. **MTLA**  
Bag of 4 assemblies

MTLA adapters are designed to work with the new MetroMax iQ Storage System and are not compatible with original MetroMax.

Extended and Easy-Grip Handles are compatible with original MetroMax Q shelves.

## Extended Handle — 9.25

Fits Shelf Depth		Extension Depth (Post to Edge of Handle)		Approx. Pkd. Wt		i and Q Cat. No.
(in.)	(mm)	(in.)	(mm)	(lbs.)	(kg)	
18	457	4.5	113	2.5	1.1	<b>MEH18S</b>
21	530	4.5	113	2.6	1.2	<b>MEH21S</b>
24	610	4.5	113	2.8	1.3	<b>MEH24S</b>



## Easy-Grip Handle — 9.25

Fits Shelf Depth		Extension Depth (Post to Edge of Handle)		Approx. Pkd. Wt		i and Q Cat. No.
(in.)	(mm)	(in.)	(mm)	(lbs.)	(kg)	
18	457	6	151	2.5	1.1	<b>MERGH18S</b>
24	610	6	151	3.0	1.4	<b>MERGH24S</b>



## Swing-up Handle — 9.25

- Ideal for maneuvering heavier loads.

Fits Shelf Depth		Extension Depth (Post to Edge of Handle)		Approx. Pkd. Wt		i and Q Cat. No.
(in.)	(mm)	(in.)	(mm)	(lbs.)	(kg)	
24	610	17.75	447	4.5	2.0	<b>MSUH24S</b>





MetroMax i®  
with Open Grid Shelves



MetroMax i®  
with Solid Shelves

MetroMax i® — Stem Caster Carts

- Corrosion proof shelves and posts; removable polymer mats.
- Standard Units consist of four shelves, MX63UP posts 63" (1600mm), wedge connectors and choice of resilient rubber or polyurethane casters.
- Approximate cart height — 67<sup>5</sup>/<sub>16</sub>" (1710mm). Weight capacity of cart: 900 lbs. (408kg) evenly distributed.

MetroMax i® Open Grid

Nominal Width/Length (in.)	Nominal Width/Length (mm)	Approx. Pkd. Wt.		Cat. No. 2-Swivel 2-Brake Resilient Rubber Casters	Cat. No. 2-Swivel 2-Brake Poly Casters
		(lbs.)	(kg)		
18x36	457x914	74	33	<b>X336BGX3</b>	<b>X336EGX3</b>
18x48	457x1220	86	38	<b>X356BGX3</b>	<b>X356EGX3</b>
18x60	457x1524	98	44	<b>X366BGX3</b>	<b>X366EGX3</b>
24x36	610x914	82	37	<b>X536BGX3</b>	<b>X536EGX3</b>
24x48	610x1220	98	44	<b>X556BGX3</b>	<b>X556EGX3</b>
24x60	610x1524	114	51	<b>X566BGX3</b>	<b>X566EGX3</b>

MetroMax i® Solid Shelves

Approx. Pkd. Wt. (lbs.)	Approx. Pkd. Wt. (kg)	Cat. No. 2-Swivel 2-Brake Poly Casters
94	42	<b>X336EFX3</b>
106	48	<b>X356EFX3</b>
118	53	<b>X366EFX3</b>
102	46	<b>X536EFX3</b>
118	53	<b>X556EFX3</b>
134	60	<b>X566EFX3</b>



MetroMax Q®  
with Open Grid Shelves

MetroMax Q® — Stem Caster Cart, Open Grid Shelves

- Quick adjust shelves with removable polymer shelf mats.
- Standard Units consist of four open grid shelves, MQ63UPE posts 63" (1600mm), wedge connectors, and choice of resilient rubber or polyurethane casters.
- Approximate cart height — 67<sup>5</sup>/<sub>16</sub>" (1710mm). Weight capacity of cart: 900 lbs. (408kg) evenly distributed.

Nominal Width/Length (in.)	Nominal Width/Length (mm)	Approx. Pkd. Wt.		Cat. No. 2-Swivel 2-Brake Resilient Rubber Casters	Cat. No. 2-Swivel 2-Brake Poly Casters
		(lbs.)	(kg)		
18x36	457x914	68	31	<b>Q336BG3</b>	<b>Q336EG3</b>
18x48	457x1220	84	38	<b>Q356BG3</b>	<b>Q356EG3</b>
18x60	457x1524	100	45	<b>Q366BG3</b>	<b>Q366EG3</b>
21x36	530x914	74	34	<b>Q436BG3</b>	<b>Q436EG3</b>
21x48	530x1220	90	41	<b>Q456BG3</b>	<b>Q456EG3</b>
21x60	530x1524	106	48	<b>Q466BG3</b>	<b>Q466EG3</b>
24x36	610x914	80	36	<b>Q536BG3</b>	<b>Q536EG3</b>
24x48	610x1220	96	44	<b>Q556BG3</b>	<b>Q556EG3</b>
24x60	610x1524	112	51	<b>Q566BG3</b>	<b>Q566EG3</b>

Stem Caster Carts with Solid Bottom MetroMax i® Shelves

- 5-tier models with Microban® antimicrobial product protection.
- Standard Units consist of 5 shelves (4 open grid, 1 MetroMax i solid), 74" (1880mm) posts, wedge connectors, and polyurethane casters.
- Approximate cart height — 79<sup>5</sup>/<sub>16</sub>" (2015mm). Weight capacity of cart: 900 lbs. (408kg) evenly distributed.



MetroMax i®  
with a Solid Bottom Shelf

Nominal Width/Length (in.)	Nominal Width/Length (mm)	Approx. Pkd. Wt.		i		Q	
		(lbs.)	(kg)	2-Swivel 2-Brake Poly Casters Cat. No.	Approx. Pkd. Wt. (lbs.) (kg)	2-Swivel 2-Brake Poly Casters Cat. No.	
18x36	457x914	82	37	<b>5X337EGX3</b>	85	39	<b>5Q337EG3</b>
18x48	457x1220	109	49	<b>5X357EGX3</b>	111	50	<b>5Q357EG3</b>
18x60	457x1524	121	55	<b>5X367EGX3</b>	123	56	<b>5Q367EG3</b>
24x36	610x914	102	46	<b>5X537EGX3</b>	104	47	<b>5Q537EG3</b>
24x48	610x1220	123	56	<b>5X557EGX3</b>	125	57	<b>5Q557EG3</b>
24x60	610x1524	141	63	<b>5X567EGX3</b>	144	65	<b>5Q567EG3</b>

# Push ahead.

Give yourself the versatility you need with Metro Utility Carts.

## Utility Carts

- Can be used in a variety of unique transport applications.
- Durable materials, ergonomic handles, and premium casters promote long life and ease of use.
- Microban product protection built into the shelf mats, frames, and posts.
- Easier to clean with removable shelf mats.

## MetroMax i® Utility Carts

- Corrosion proof shelves, posts, and Type 304 stainless steel handle.
- Corrosion resistant 5PCX casters with 5" (127mm) polyurethane wheels, polymer horns, and stainless steel axles.
- 39 1/4" (997mm) tall. Weight capacity of cart: 900 lbs. (408kg) evenly distributed.

Nominal Width/Length (in.) (mm)		Actual Width/Length (in.) (mm)		Description	Approx. Pkd. Wt. (lbs.) (kg)		Cat. No.
18x30	457x760	20 5/16 x 34 1/2	516 x 876		2-shelf	35.5	
24x36	610x914	26 5/16 x 40 1/2	668 x 1029	2-shelf	46.0	20.5	<b>MXUC2436G-25</b>
18x30	457x760	20 5/16 x 34 1/2	516 x 876	3-shelf	46.0	20.5	<b>MXUC1830G-35</b>
24x36	610x914	26 5/16 x 40 1/2	668 x 1029	3-shelf	61.5	27.5	<b>MXUC2436G-35</b>



## MetroMax Q® Utility Carts

- Quick adjust corrosion resistant shelves and posts.
- Corrosion proof Type 304 stainless steel handle.
- Includes four 5MPX casters with 5" (127mm) polyurethane wheels.
- 39 1/4" (997mm) tall. Weight capacity of cart: 900 lbs. (408kg) evenly distributed.

Nominal Width/Length (in.) (mm)		Actual Width/Length (in.) (mm)		Description	Approx. Pkd. Wt. (lbs.) (kg)		Cat. No.
18x30	457x760	20 5/16 x 34 1/2	516 x 876		2-shelf	35.5	
24x36	610x914	26 5/16 x 40 1/2	668 x 1029	2-shelf	46.0	20.5	<b>MQUC2436G-25</b>
18x30	457x760	20 5/16 x 34 1/2	516 x 876	3-shelf	46.0	20.5	<b>MQUC1830G-35</b>
24x36	610x914	26 5/16 x 40 1/2	668 x 1029	3-shelf	61.5	27.5	<b>MQUC2436G-35</b>



## Helpful Hints

- Configure a cart to your exact needs using a combination of MetroMax i® and Q™ shelves and posts.
- Consider MetroMax i solid shelves when spill containment is required or to protect supplies from dirt during transport.
- A typical utility cart will be configured using 27" (685mm) or 33" (875mm) stem caster posts with 5" (127mm) casters.



Solid bottom shelf and 5PCX/5PCBX casters pictured

**Shelves and posts: pages 14-15   Casters: page 16   Handles: page 17**



Add-On units with "S" hooks can only be attached to shelves supported by two or more posts.

MetroMax i® Shelving Starter and Add-On Units

- Save time and money by eliminating adjacent posts and replacing with "S" hooks.
- Starter Units consist of four posts and indicated number of MetroMax i shelves.
- Add-On Units consist of two posts, indicated number of shelves, and two "S" Hooks per shelf, for attaching shelf to adjacent unit. To attach shelves at right angles, Intermediate "S" Hook Kits must be ordered separately.

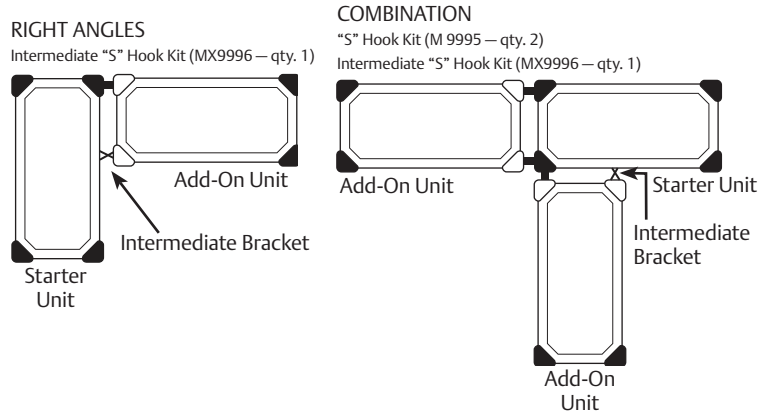
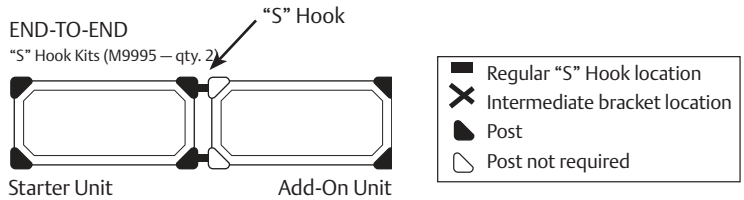

"S" Hook  
Cat. No. **M9995**

"S" Hook

Add on shelving to existing units using two posts instead of four. Kit includes one "S" hook and one corner collar plug. Two kits required per storage level when configuring units end-to-end.  
Cat. No. **M9995**



Intermediate "S" Hook Kit  
Cat. No. **MX9996**

MetroMax i® Intermediate "S" Hook Kit

Required when joining units at right angles with open corner and no post. Intermediate bracket connects a shelf corner to the front beam of the adjoining shelf. Kit includes one intermediate bracket, two "S" Hooks, and two corner collar plugs. See illustration for quantity required per level.  
Cat. No. **MX9996**



Collar plug fits MetroMax i

Shelving Starter and Add-On Units – Easy Order Guide

		18" (457mm) Wide		24" (610mm) Wide	
		Starter	Add-On	Starter	Add-On
24" (610mm)	Cat. No.	5X317GX3	5AX317GX3	5X517GX3	5AX517GX3
Long	Wt. lbs. (kg)	60 (27)	55 (25)	65 (29)	60 (27)
30" (760mm)	Cat. No.	5X327GX3	5AX327GX3	5X527GX3	5AX527GX3
Long	Wt. lbs. (kg)	65 (29)	60 (27)	80 (36)	75 (34)
36" (914mm)	Cat. No.	5X337GX3	5AX337GX3	5X537GX3	5AX537GX3
Long	Wt. lbs. (kg)	70 (32)	65 (29)	85 (39)	80 (36)
42" (1066mm)	Cat. No.	5X347GX3	5AX347GX3	5X547GX3	5AX547GX3
Long	Wt. lbs. (kg)	80 (36)	75 (34)	95 (43)	90 (41)
48" (1219mm)	Cat. No.	5X357GX3	5AX357GX3	5X557GX3	5AX557GX3
List Price Each		980.50	926.50	1,163.00	1,109.00
Long	Wt. lbs. (kg)	90 (41)	85 (39)	105 (48)	100 (45)
60" (1524mm)	Cat. No.	5X367GX3	5AX367GX3	5X567GX3	5AX567GX3
Long	Wt. lbs. (kg)	110 (50)	105 (48)	115 (52)	110 (50)
72" (1825mm)	Cat. No.	5X377GX3	5AX377GX3	5X577GX3	5AX577GX3
Long	Wt. lbs. (kg)	125 (57)	120 (54)	145 (66)	140 (64)

Note: "Right Angle" Add-On Units require one additional Intermediate "S" Hook kit per shelf level.

## MetroMax Q® Shelving Starter and Add-On Units

- Save time and money by eliminating adjacent posts and replacing with “S” hooks.
- Starter Units consist of four posts and indicated number of MetroMax Q shelves.
- Add-On Units consist of two posts, indicated number of shelves, and two “S” Hooks per shelf, for attaching shelf to adjacent unit. To attach shelves at right angles, Intermediate “S” Hook Kits must be ordered separately.

### END-TO-END

“S” Hook Kits (M9995 – qty. 2)

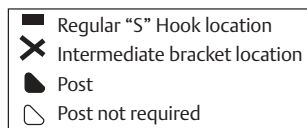
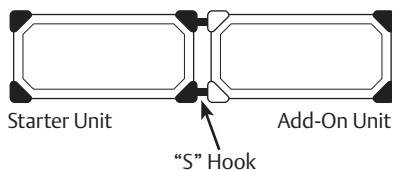

### RIGHT ANGLES

Intermediate “S” Hook Kit (Q9995Z – qty. 1)

“S” Hook Kits (M9995 – qty. 1)

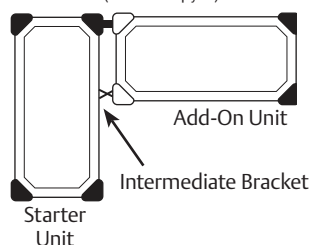

### COMBINATION

“S” Hook Kit (M 9995 – qty. 3)

Intermediate “S” Hook Kit (MX9996 – qty. 1)

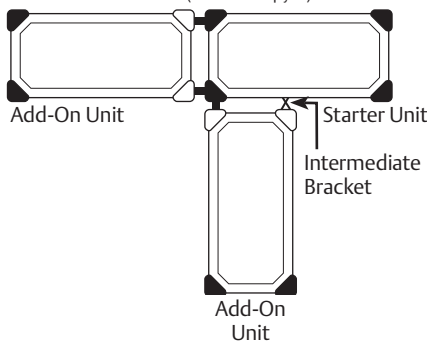

Add-On units with “S” hooks can only be attached to shelves supported by two or more posts.

### “S” Hook

Add on shelving using two posts instead of four. Includes one “S” hook. Two kits required per level when configuring units end-to-end. Cat. No. **M9995**

**Note:** Collar/hole plug is designed for use with MetroMax i shelves only.



“S” Hook  
Cat. No. **M9995**

### MetroMax Q® Intermediate “S” Hook Kit

Use when configuring MetroMax Q Starter and Add-On Units at right angles.

Cat. No. **Q9995Z**



Intermediate “S”  
Hook Kit  
Cat. No. **Q9995Z**

## Shelving Starter and Add-On Units — Easy Order Guide

5 Shelves  
74" (1880mm) Posts

	Cat. No.	18" (457mm) Wide		21" (530mm) Wide		24" (610mm) Wide	
		Starter	Add-On	Starter	Add-On	Starter	Add-On
24" (610mm)		5Q317G3	5AQ317G3	5Q417G3	5AQ417G3	5Q517G3	5AQ517G3
Long	Wt. lbs. (kg)	50.4 (23)	40.4 (18)	56.4 (26)	46.4 (21)	56.4 (26)	46.4 (21)
30" (760mm)		5Q327G3	5AQ327G3	5Q427G3	5AQ427G3	5Q527G3	5AQ527G3
Long	Wt. lbs. (kg)	57.9 (26)	47.9 (22)	63.1 (29)	53.1 (24)	66.4 (30)	56.4 (26)
36" (914mm)		5Q337G3	5AQ337G3	5Q437G3	5AQ437G3	5Q537G3	5AQ537G3
Long	Wt. lbs. (kg)	65.4 (30)	55.4 (25)	70.9 (32)	60.9 (28)	76.4 (35)	65.4 (30)
42" (1066mm)		5Q347G3	5AQ347G3	5Q447G3	5AQ447G3	5Q547G3	5AQ547G3
Long	Wt. lbs. (kg)	72.9 (33)	62.9 (29)	82.1 (37)	72.1 (33)	86.4 (39)	78.4 (36)
48" (1219mm)		5Q357G3	5AQ357G3	5Q457G3	5AQ457G3	5Q557G3	5AQ557G3
Long	Wt. lbs. (kg)	80.4 (36)	70.4 (32)	89.4 (41)	79.4 (36)	96.4 (44)	86.4 (39)
60" (1524mm)		5Q367G3	5AQ367G3	5Q467G3	5AQ467G3	5Q567G3	5AQ567G3
Long	Wt. lbs. (kg)	95.4 (43)	85.4 (39)	106.4 (48)	96.4 (44)	116.4 (53)	106.4 (48)
72" (1825mm)		5Q377G3	5AQ377G3	5Q477G3	5AQ477G3	5Q577G3	5AQ577G3
Long	Wt. lbs. (kg)	110.4 (50)	100.4 (46)	121.4 (55)	111.4 (51)	136.4 (62)	126.4 (57)



# Organize.

## Organize supplies to improve operational efficiencies.

- Well-organized storage results in fewer expired supplies and less waste.
- Innovative shelf and accessory designs have smooth surfaces that protect vacuum sealed and other packaged items from damage.
- Flexible compartments help sort supplies for faster access and maximize the use of storage space.

A Dividers B Ledges C Enclosure Panels D Metro Totes E Metro Bins

## Flexible Compartments

**Dividers and Ledges** can be used to create flexible compartments that most efficiently use available storage space. When combined with open grid shelves this minimizes dust accumulation.

**Bins** offer removable compartmentalized storage for easy access or as part of an exchange system. See page 60 for Bin options.



### 8" (203mm) Shelf Dividers — Standard Duty — 9.25

- i and Q versions available.
- Use to create organized compartments or to simply separate shelf contents.
- Easily repositioned on grid and solid shelves.
- Corrosion proof.

Nominal Length (in.)	(mm)	Approx. Pkd. Wt.		i Cat. No.	Q Cat. No.
		(lbs.)	(kg)		
18	457	1.3	0.6	<b>MXD18-8</b>	<b>MQD18-8</b>
24	610	1.6	0.7	<b>MXD24-8</b>	<b>MQD24-8</b>

\*Note: Can be retrofitted to original MetroMax and MetroMax Q.

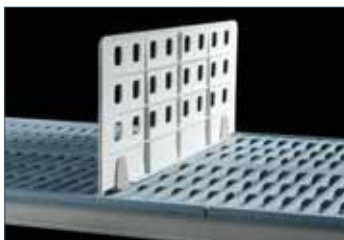

### Universal 8" (203mm) Shelf Dividers — Light Duty, for open grid shelves — 9.25

- For use with MetroMax i and Q grid shelves, Super Erecta wire shelves, and Super Adjustable wire shelves.
- Maximum flexibility: Can be repositioned along the entire shelf.
- Each divider includes a panel and two clips to connect to any open grid or wire shelf. Does not attach to solid shelves.
- Corrosion proof.

Nominal Length (in.)	(mm)	Fits Shelf Depth		Approx. Pkd. Wt.		i and Q Cat. No.
		18"	21" (457, 530mm)	(lbs.)	(kg)	
18	457	18"	21" (457, 530mm)	1.3	0.6	<b>MUD18-8</b>
24	610	24"	(610mm)	1.6	0.7	<b>MUD24-8</b>

\*Note: Can be retrofitted to original MetroMax and MetroMax Q.  
Additional clips: Cat. No **DCLIP**, 2 per bag, List Price 5.50

### Shelf-to-Shelf Dividers — 9.25

- Full height dividers efficiently compartmentalize the space between two shelves.
- Smooth surfaces protect packaged items from damage.
- Corrosion proof.
- Compatible with MetroMax i and Q open grid shelves, Super Erecta wire shelves, and Super Adjustable wire shelves. Does not work with solid shelves.

Fits Shelf Depth		Nominal Depth	Approx. Pkd. Wt.		i and Q Cat. No.
(in.)	(mm)		(in.)	(mm)	
18, 21	457, 530	16	406	2.3 1.0	MD18-16
18, 21	457, 530	20	508	2.5 1.1	MD18-20
18, 21	457, 530	24	610	3.8 1.7	MD18-24
24	610	16	406	2.8 1.2	MD24-16
24	610	20	508	3.0 1.3	MD24-20
24	610	24	610	4.4 2.0	MD24-24

\*Note: Can be retrofitted to original MetroMax and MetroMax Q shelves.  
 \*Note: -16 parts have three panels, -20 parts have four panels, -24 parts have five panels.



### 2" (51mm) Stackable Shelf Ledges — 9.25

- Prevent items from falling off shelves.
- Snap on and off quickly. Easily stacked to contain larger items.
- Corrosion proof.
- Ships assembled.

Nominal Length	Type	Approx. Pkd. Wt.		i	Q
		(lbs.)	(kg)	Cat. No.	Cat. No.
18 457	Side	0.50	0.2	MXLS18-2S	MQLS18-2S
21 530	Side	0.50	0.2	—	MQLS21-2S
24 610	Side	0.50	0.2	MXLS24-2S	MQLS24-2S
24 610	Back	0.50	0.2	MXL24-2S	MQL24-2S
30 760	Back	0.75	0.3	MXL30-2S	MQL30-2S
36 914	Back	1.00	0.4	MXL36-2S	MQL36-2S
42 1066	Back	1.25	0.6	MXL42-2S	MQL42-2S
48 1219	Back	1.25	0.6	MXL48-2S	MQL48-2S
54 1370	Back	1.50	0.7	MXL54-2S	MQL54-2S
60 1524	Back	1.75	0.8	MXL60-2S	MQL60-2S
72 1829	Back	2.00	0.9	MXL72-2S	MQL72-2S

\*Note: MetroMax i wire ledges can be retrofitted to original MetroMax.  
 \*Note: MetroMax Q wire ledges (MQ-) cannot be retrofitted to original MetroMax Q.



### 4" (102mm) Solid Clear Stackable Shelf Ledges — 9.26

- Solid design helps contain small items.
- Clear plastic allows light penetration and visible access to supplies.
- Corrosion proof.
- Ships assembled.

Nominal Length	Type	Approx. Pkd. Wt.		i	Q
		(lbs.)	(kg)	Cat. No.	Cat. No.
18 457	Side	0.50	0.2	MXLS18-4P	MQLS18-4P
21 530	Side	0.50	0.2	—	MQLS21-4P
24 610	Side	0.50	0.2	MXLS24-4P	MQLS24-4P
24 610	Back	0.50	0.2	MXL24-4P	MQL24-4P
30 760	Back	0.75	0.3	MXL30-4P	MQL30-4P
36 914	Back	1.00	0.4	MXL36-4P	MQL36-4P
42 1066	Back	1.25	0.6	MXL42-4P	MQL42-4P
48 1219	Back	1.25	0.6	MXL48-4P	MQL48-4P
54 1370	Back	1.50	0.7	MXL54-4P	MQL54-4P
60 1524	Back	1.75	0.8	MXL60-4P	MQL60-4P

\*Note: MetroMax i wire ledges can be retrofitted to original MetroMax.  
 \*Note: MetroMax Q wire ledges (MQ-) cannot be retrofitted to original MetroMax Q.  
 Note: Not suitable for cart-wash applications.





# Contain it.

Efficiently enclose and contain with Enclosure Panels.

Enclosure Panels — **9.25**

- An efficient way of enclosing the sides and back of all shelves in a unit to contain stored contents.
- Slot opening: 3" W x 3<sup>7</sup>/<sub>8</sub>" H.
- Designed to work with MetroMax i® and MetroMax Q® shelves. Mounting clips included.

Use shelf to shelf dividers with enclosure panels to create full height compartments to organize bulky, hard-to-handle supplies.

Actual Width/Height (in./mm)		Post Height (in./mm)		For use with Shelf Width (in./mm)		Approx. Pkd. Wt. (lbs./kg)		i and Q Cat. No.
12 <sup>3</sup> / <sub>8</sub> x 51 <sup>1</sup> / <sub>4</sub>	315 x 1300	54	1370	18	457	6 <sup>1</sup> / <sub>4</sub>	2.8	MEP35E
12 <sup>3</sup> / <sub>8</sub> x 59 <sup>1</sup> / <sub>4</sub>	315 x 1505	63	1600	18	457	7	3.2	MEP36E
12 <sup>3</sup> / <sub>8</sub> x 71 <sup>1</sup> / <sub>4</sub>	315 x 1810	74	1880	18	457	8 <sup>3</sup> / <sub>4</sub>	4.0	MEP37E
18 <sup>3</sup> / <sub>8</sub> x 51 <sup>1</sup> / <sub>4</sub>	467 x 1300	54	1370	21, 24	530, 610	9	4.1	MEP55E
18 <sup>3</sup> / <sub>8</sub> x 59 <sup>1</sup> / <sub>4</sub>	467 x 1505	63	1600	21, 24	530, 610	10 <sup>1</sup> / <sub>4</sub>	4.7	MEP56E
18 <sup>3</sup> / <sub>8</sub> x 71 <sup>1</sup> / <sub>4</sub>	467 x 1810	74	1880	21, 24	530, 610	11 <sup>3</sup> / <sub>4</sub>	5.3	MEP57E

\*Note: Can be retrofitted to original MetroMax and MetroMax Q shelving.

Panels Required to Enclose Both Ends of the Shelving Unit or Cart

Post Height	Shelf Width		
	18" (457mm)	21" (530mm)	24" (610mm)
54" (1370mm)	(2) MEP35E	(2) MEP55E	(2) MEP55E
63" (1600mm)	(2) MEP36E	(2) MEP56E	(2) MEP56E
74" (1880mm)	(2) MEP37E	(2) MEP57E	(2) MEP57E

Configuration Notes

1. Handles and enclosure panels can be used on the same end of the cart. Please note the following details: 21" (530mm) wide units; use the 12<sup>3</sup>/<sub>8</sub>" (315mm) wide panel on the same end as the handle.
2. Top-Track: When using on the ends of a Top-Track mobile unit the enclosure panel must be mounted so that it does not interfere with the overhead tracks. Mobile posts on Top-Track are 74" (1880mm). The standard enclosure panel for 74" (1880mm) posts can be used but must be mounted in a lower position on the unit. As an alternative, the standard panels for a 63" (1600mm) post can be used.

Panels Required to Enclose Back of Shelving Unit or Cart

Post Height	Shelf Length						
	30" (760mm)	36" (914mm)	42" (1066mm)	48" (1219mm)	54" (1370mm)	60" (1524mm)	72" (1825mm)
54" (1370mm)	(2) MEP35E	(1) MEP35E (1) MEP55E	(2) MEP55E	(2) MEP35E (1) MEP55E	(1) MEP35E (2) MEP55E	(3) MEP55E	(1) MEP35E (3) MEP55E
63" (1600mm)	(2) MEP36E	(1) MEP36E (1) MEP56E	(2) MEP56E	(2) MEP36E (1) MEP56E	(1) MEP36E (2) MEP56E	(3) MEP56E	(1) MEP36E (3) MEP56E
74" (1880mm)	(2) MEP37E	(1) MEP37E (1) MEP57E	(2) MEP57E	(2) MEP37E (1) MEP57E	(1) MEP37E (2) MEP57E	(3) MEP57E	(1) MEP37E (3) MEP57E



Enclosure Panel



MetroMax i® Mounting Clip Replacements  
Cat. No. RPMX3-RODTAB



MetroMax Q® Mounting and Bottom Adapter Clip Replacements  
Cat. No. RPMQ3-RODTAB





### Label Holders

- Plastic holders snap onto shelf edge to accommodate 1" (25mm) tall adhesive label. Label not included.
- i and Q versions available.
- Optional label holder covers exist for MetroMax Q models. Cover snaps onto the label holder to hold a non-adhesive label in place or to protect any label from dirt and moisture.



### MetroMax i® — 9.25

Height: 1" (25mm)

Actual Length		Fits Shelf Length		Approx. Pkd. Wt.		Cat. No.
(in.)	(mm)	(in.)	(mm)	(lbs.)	(kg)	Label Holder
4 1/2	114	All		0.03	0.01	9989PX
11 9/32	285	24	610	0.14	0.06	9989X1
17 9/32	438	30	760	0.24	0.10	9989X2
23 9/32	590	36	914	0.30	0.13	9989X3
29 9/32	742	42	1060	0.35	0.15	9989X4
35 9/32	895	48	1219	0.40	0.18	9989X5
41 9/32	1047	54	1370	0.45	0.20	9989X6

### MetroMax Q® — 9.25

Height: 1 1/2" (37mm)

Actual Length		Fits Shelf Length		Approx. Pkd. Wt.		Cat. No.	Cat. No.
(in.)	(mm)	(in.)	(mm)	(lbs.)	(kg)	Label Holder	Label Holder Cover
4	102	All		0.03	0.01	Q04LH	Q04LHC
17 5/8	448	24	610	0.14	0.06	Q24LH	Q24LHC
23 5/8	600	30	760	0.24	0.10	Q30LH	Q30LHC
29 5/8	752	36	914	0.30	0.13	Q36LH	Q36LHC
35 5/8	905	42	1060	0.35	0.15	Q42LH	Q42LHC
41 5/8	1057	48	1219	0.40	0.18	Q48LH	Q48LHC
47 5/8	1210	54	1370	0.45	0.20	Q54LH	Q54LHC
53 5/8	1362	60	1524	0.50	0.22	Q60LH	Q60LHC
59 5/8	1514	72	1825	0.60	0.27	Q72LH	—

### Color Shelf Markers — 9.25

- Attach easily to shelf for content identification.
- Use to assign color coding to individual shelf levels, shelving units, carts, or storage areas.
- i and Q versions available.
- 6" (152mm) length.

Shelf Marker Color	Approx. Pkd. Wt.		i		Q	
	(lbs.)	(kg)	Cat. No.	Cat. No.	Cat. No.	Cat. No.
Blue	0.05	0.02	CSM6-BX	CSM6-BQ		
Green	0.05	0.02	CSM6-GX	CSM6-GQ		
Red	0.05	0.02	CSM6-RX	CSM6-RQ		
Tan	0.05	0.02	CSM6-TX	CSM6-TQ		
White	0.05	0.02	CSM6-WX	CSM6-WQ		
Yellow	0.05	0.02	CSM6-YX	CSM6-YQ		
Gray	0.05	0.02	CSM6-GRX	CSM6-GRQ		



MetroMax i® Label Holder



MetroMax Q® Label Holder



MetroMax i® Color Shelf Marker

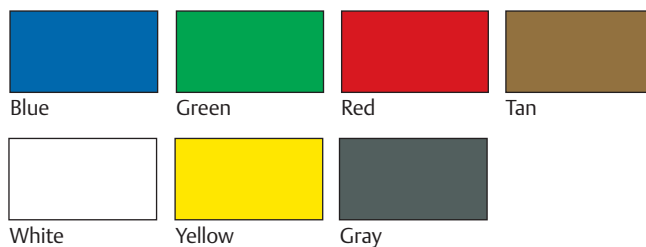

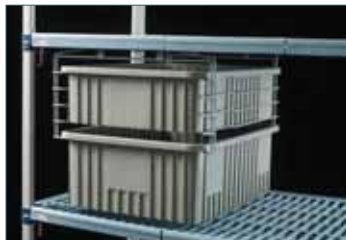

**Super Slide — 9.25**

- Designed to fit a 24" (610mm) wide shelf.
- Easily attaches to the shelf frame (under the mats) and is sized to hold 3", 5", 6", and 8" (76, 127, 152, 203mm) tall tote boxes (sold separately).
- MetroMax i® and Q models available.
- Corrosion resistant taupe epoxy finish with Microban antimicrobial product protection.

Width (in.) (mm)		Length (in.) (mm)		Height (in.) (mm)		Approx. Pkd. Wt. (lbs.) (kg)		i Cat. No.	Q Cat. No.
20 <sup>3</sup> / <sub>8</sub>	520	21 <sup>5</sup> / <sub>8</sub>	550	10 <sup>1</sup> / <sub>4</sub>	260	5 <sup>1</sup> / <sub>4</sub>	2	<b>MXSS2E</b>	<b>MQSS2E</b>



**Undershelf Slide — 9.25**

- Available for MetroMax i only.
- Easily attaches to the MetroMax i® shelf frame to allow you create a more versatile storage system.
- Tote box (sold separately) can serve as a drawer on mobile units or utility carts.
- Aluminum finish.

Fits Shelf Width (in.) (mm)		Length (in.) (mm)		Approx. Pkd. Wt. (lbs.) (kg)		i Cat. No.
18	457	22 <sup>3</sup> / <sub>4</sub>	578	3 <sup>1</sup> / <sub>4</sub>	1.5	<b>BSD2218XA</b>
24	610	17 <sup>3</sup> / <sub>4</sub>	451	3 <sup>3</sup> / <sub>4</sub>	1.7	<b>BSD2224XB</b>



**Adjustable Slides — 9.25**

- Slides can be adjusted left to right to accommodate a variety of pan, tray, and container sizes.
- MetroMax i® and Q models available.
- Corrosion resistant taupe epoxy finish with Microban antimicrobial product protection.
- Shelves must be spaced 20" (508mm) apart.
- Can be used in conjunction with 20" (508mm) tall shelf-to-shelf dividers.

Fits Shelf Width (in.) (mm)		Type	Approx. Pkd. Wt. (lbs.) (kg)		i Cat. No.	Q Cat. No.
18	457	Adjustable	10 <sup>3</sup> / <sub>4</sub>	5	<b>MX18SE</b>	<b>MQ18SE</b>
24	610	Adjustable	12 <sup>3</sup> / <sub>4</sub>	6	<b>MX24SE</b>	<b>MQ24SE</b>



**Can Rack System — 9.25**

- Front loading, front dispensing can rack holds eight #10 cans or twelve #5 cans.
- Tough, corrosion resistant taupe epoxy finish with Microban antimicrobial product protection.
- Designed to fit a 24" (610mm) wide shelf.
- Mounts on any MetroMax i® or MetroMax Q shelf.

Width/Length/Height (in.) (mm)		Approx. Pkd. Wt. (lbs.) (kg)		i and Q Cat. No.
7 <sup>1</sup> / <sub>8</sub> x25 <sup>5</sup> / <sub>16</sub> x15	200x643x381	10	4.5	<b>CR24E</b>

## Storage Level Frames — 9.25

- Open four sided frames accommodate drop-in accessories including wire baskets and stainless drying racks.
- Includes corrosion proof MetroMax i® frame and a bag of wedges.

Width (in.) (mm)		Length (in.) (mm)		Width/Length (in.) (mm)		Approx. Pkd. Wt. (lbs.) (kg)		<b>i and Q</b> Cat. No.
18	457	24	610	18x20	457x510	4 <sup>3</sup> / <sub>4</sub>	2.2	<b>M4F1824</b>
18	457	30	760	18x26	457x660	6	2.7	<b>M4F1830</b>
18	457	36	914	18x32	457x810	7	3.2	<b>M4F1836</b>
18	457	42	1060	18x38	457x965	8 <sup>1</sup> / <sub>4</sub>	3.8	<b>M4F1842</b>
18	457	48	1220	18x44	457x1120	9 <sup>1</sup> / <sub>2</sub>	4.3	<b>M4F1848</b>
18	457	54	1372	18x50	457x1219	10 <sup>1</sup> / <sub>2</sub>	4.8	<b>M4F1854</b>
18	457	60	1524	18x56	457x1370	11 <sup>3</sup> / <sub>4</sub>	5.3	<b>M4F1860</b>
18	457	72	1829	18x68	457x1725	14	6.4	<b>M4F1872</b>
24	610	24	610	24x20	610x510	7 <sup>1</sup> / <sub>2</sub>	3.4	<b>M4F2424</b>
24	610	30	760	24x26	610x660	9 <sup>1</sup> / <sub>2</sub>	4.3	<b>M4F2430</b>
24	610	36	914	24x32	610x810	11 <sup>1</sup> / <sub>4</sub>	5.1	<b>M4F2436</b>
24	610	42	1060	24x38	610x965	13 <sup>1</sup> / <sub>4</sub>	6	<b>M4F2442</b>
24	610	48	1220	24x44	610x1120	15	6.8	<b>M4F2448</b>
24	610	54	1372	24x50	610x1219	17	7.7	<b>M4F2454</b>
24	610	60	1524	24x56	610x1370	18 <sup>3</sup> / <sub>4</sub>	8.5	<b>M4F2460</b>
24	610	72	1829	24x68	610x1725	22 <sup>1</sup> / <sub>2</sub>	10.2	<b>M4F2472</b>

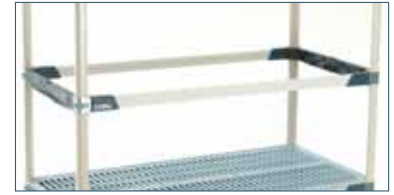

## Configuration Chart

FRAME	QTY to fill out shelf frame.			
	B1816XE	B1822XE	B2416XE	B2422XE
M4F1836	2			
M4F1842	1	1		
M4F1848		2		
M4F1860	2	1		
M4F1872		3		
M4F2436		2		
M4F2442		1	1	
M4F2448				2
M4F2460		2	1	
M4F2472				3

## Wire Baskets — 9.25

- Conveniently hold small items.
- 9" (229mm) deep.
- Built in storage handles allow easy removal.
- Corrosion resistant taupe epoxy finish.

Width (in.) (mm)		Length (in.) (mm)		Approx. Pkd. Wt. (lbs.) (kg)		Cat. No.
18	457	16	406	9	4.1	<b>MB1816XE</b>
18	457	22	560	10	4.5	<b>MB1822XE</b>
24	610	16	406	10	4.5	<b>MB2416XE</b>
24	610	22	560	12	5.5	<b>MB2422XE</b>



## 3-sided Frames — 9.25

- 1"x1<sup>1</sup>/<sub>2</sub>" (25x38mm) structural steel tubing. Includes tri-lobal adapters to attach to posts. (Replacement adapters: Cat. No. MTLA, bag of 4).
- Corrosion resistant taupe epoxy finish.
- Use when configuring work tables or as a 3-sided ledge to contain bulky items.

Width (in.) (mm)		Length (in.) (mm)		Approx. Pkd. Wt. (lbs.) (kg)		<b>i and Q</b> Cat. No.
18	457	24	610	11	5	<b>M3TF1824E</b>
18	457	30	760	12	5.4	<b>M3TF1830E</b>
18	457	36	914	13	5.7	<b>M3TF1836E</b>
18	457	48	1220	15	6.6	<b>M3TF1848E</b>
18	457	60	1524	18	8.2	<b>M3TF1860E</b>
24	610	24	610	12	5.4	<b>M3TF2424E</b>
24	610	30	760	13	5.7	<b>M3TF2430E</b>
24	610	36	914	14	6.4	<b>M3TF2436E</b>
24	610	48	1220	18	8.2	<b>M3TF2448E</b>
24	610	60	1524	20	9.1	<b>M3TF2460E</b>



# Dry it.



### MetroMax i® Drying Rack Unit — 9.31

- Allows superior air circulation and fast drying of trays, pans, lids, pots and all pot sink items.
- Promotes food safety by eliminating moisture. Offers an efficient organized drying area.
- Includes two drop-ins (Cat. No. DR48S) and one cutting board/tray drying rack (Cat. No. MTR2448XE).

#### Stationary Unit

Width (in.)	Width (mm)	Length (in.)	Length (mm)	Height (in.)	Height (mm)	Pkd. Wt. (lbs.)	Pkd. Wt. (kg)	i Cat. No.
24	610	48	1219	75½	1917	106	49	PR48X3

#### Mobile Unit

Width (in.)	Width (mm)	Length (in.)	Length (mm)	Height (in.)	Height (mm)	Pkd. Wt. (lbs.)	Pkd. Wt. (kg)	i Cat. No.
24	610	48	1219	69	1752	106	49	PR48VX3

\*Note: Includes two 5PCX swivel casters and two 5PCBX swivel casters with brakes.

### Stainless Steel Drop-in Racks — 9.25

- Open wire design provides air flow to safely dry pots, pans, and containers
- To create a storage level with a stainless drop-in order the following:
  - Qty. 1 Drop-in rack
  - Qty. 1 Four-sided MetroMax i® frame
  - Qty. 1 MetroMax i® center beam
- Can be retrofitted to existing MetroMax i® shelves. Simply remove the mats and drop in the stainless drying rack.
- Center beams: RPMX36-CBEAM, RPMX48-CBEAM, RPMX60-CBEAM.

Width (in.)	Width (mm)	Length (in.)	Length (mm)	Height (in.)	Height (mm)	Wire Spacing (in.)	Wire Spacing (mm)	Approx. Pkd. Wt. (lbs.)	Approx. Pkd. Wt. (kg)	Cat. No.
24	610	33⅞	854	5¼	133	¾	19	9	4.1	DR36S
24	610	45⅞	1156	5¼	133	¾	19	12	5.4	DR48S
24	610	57⅞	1458	5¼	133	¾	19	15	6.8	DR60S

\*Note: Can be retrofitted to original MetroMax and MetroMax Q.



### Cutting Board and Tray Drying Rack — 9.25

- Rack is mounted to standard MetroMax i® or MetroMax Q shelf.
- Promotes safe air drying of cutting boards and trays.
- 1½" (28mm) and 3" (76mm) slide spacing available.

Fits Shelf (in.)	Fits Shelf (mm)	Upright Spacing (in.)	Upright Spacing (mm)	Upright Height (in.)	Upright Height (mm)	Tray Capacity	Pkd. Wt. (lbs.)	Pkd. Wt. (kg)	i and Q Cat. No.
24x36	457x914	1½	28	6	150	24	13.5	6.1	MTR2436XE
24x48	457x1219	1½	28	6	150	34	18.0	8.2	MTR2448XE
24x60	457x1524	1½	28	6	150	42	22.5	10.2	MTR2460XE
24x36	457x914	3	76	6	150	10	9.8	4.4	MTR2436XEA
24x48	457x1219	3	76	6	150	14	13	5.9	MTR2448XEA
24x60	457x1524	3	76	6	150	17	16.3	7.4	MTR2460XEA

\*Note: Can be retrofitted to original MetroMax and MetroMax Q.

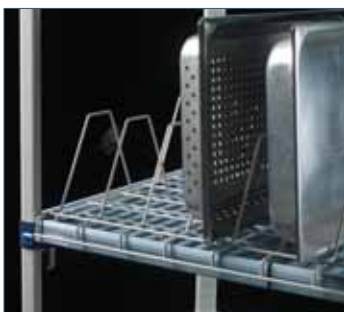



*Order today! Log on to*

***www.metro.com***

*locate a sales representative near you.*



Not in the USA? Look on the back cover  
of your catalog for the contact information you need.

“Let us make your  
next purchase easy,  
contact your  
representative today.”

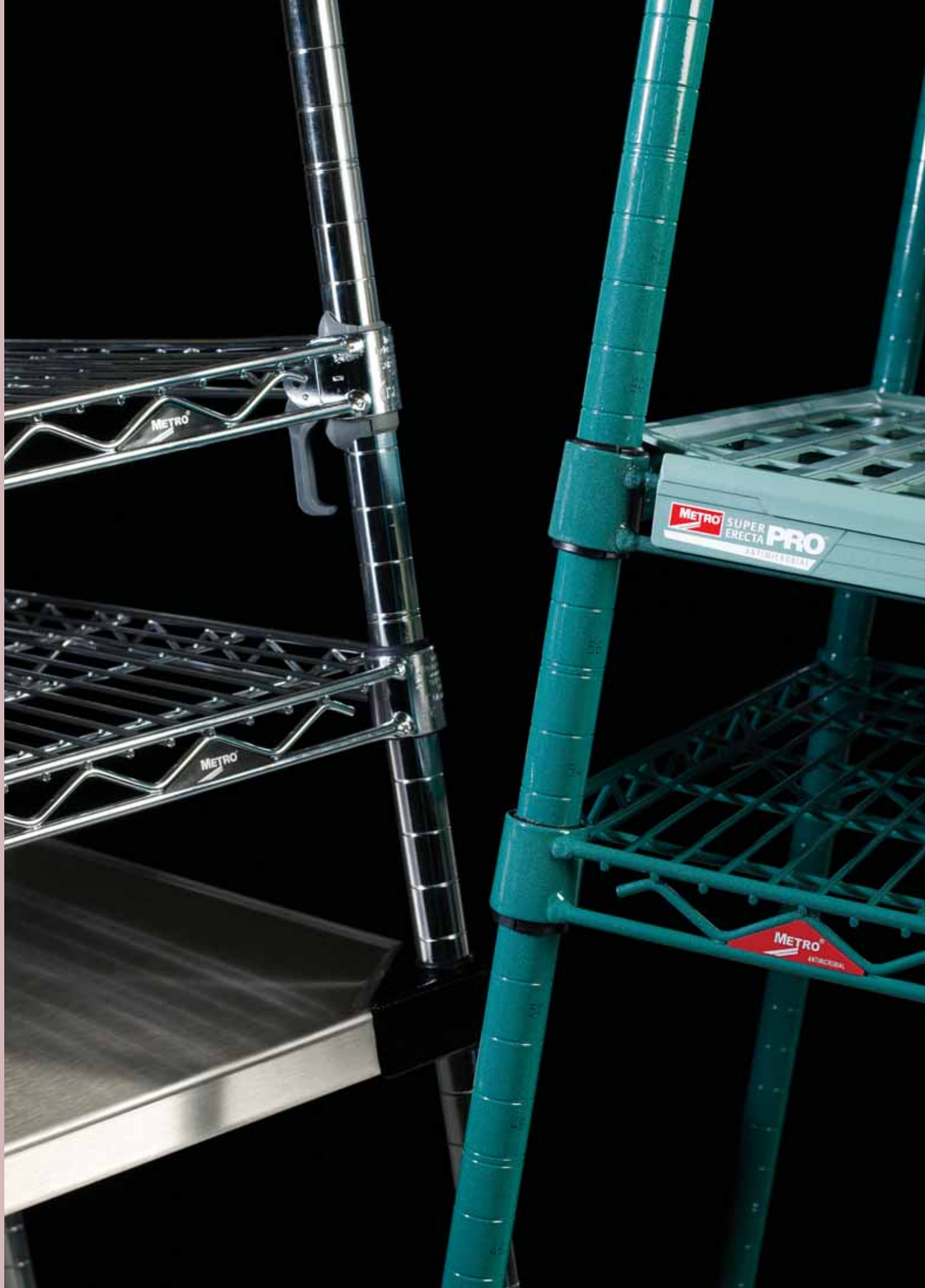

METRO

METRO

METRO SUPER ERECTA PRO

METRO ANTIBACTERIAL

# WIRE AND SOLID SHELVING SOLUTIONS

Super Erecta Pro,<sup>™</sup>  
Super Adjustable Super Erecta<sup>®</sup>  
and Super Erecta<sup>®</sup>

Wire/Polymer Hybrid Shelving .....	32-35
Easy-Adjust Shelving & Carts .....	36-39
Wire Shelving, Carts & Trucks.....	40-47
Casters & Accessories for Wire Shelving .....	48-62
Solid Shelving & Accessories .....	64-66
Light-Duty Wire Shelving & Accessories .....	67
Heavy-Duty Solid Shelving & Accessories .....	68-69

# Proven.

Genuine Metro Super Erecta®  
The industry standard — innovated and reinnovated.

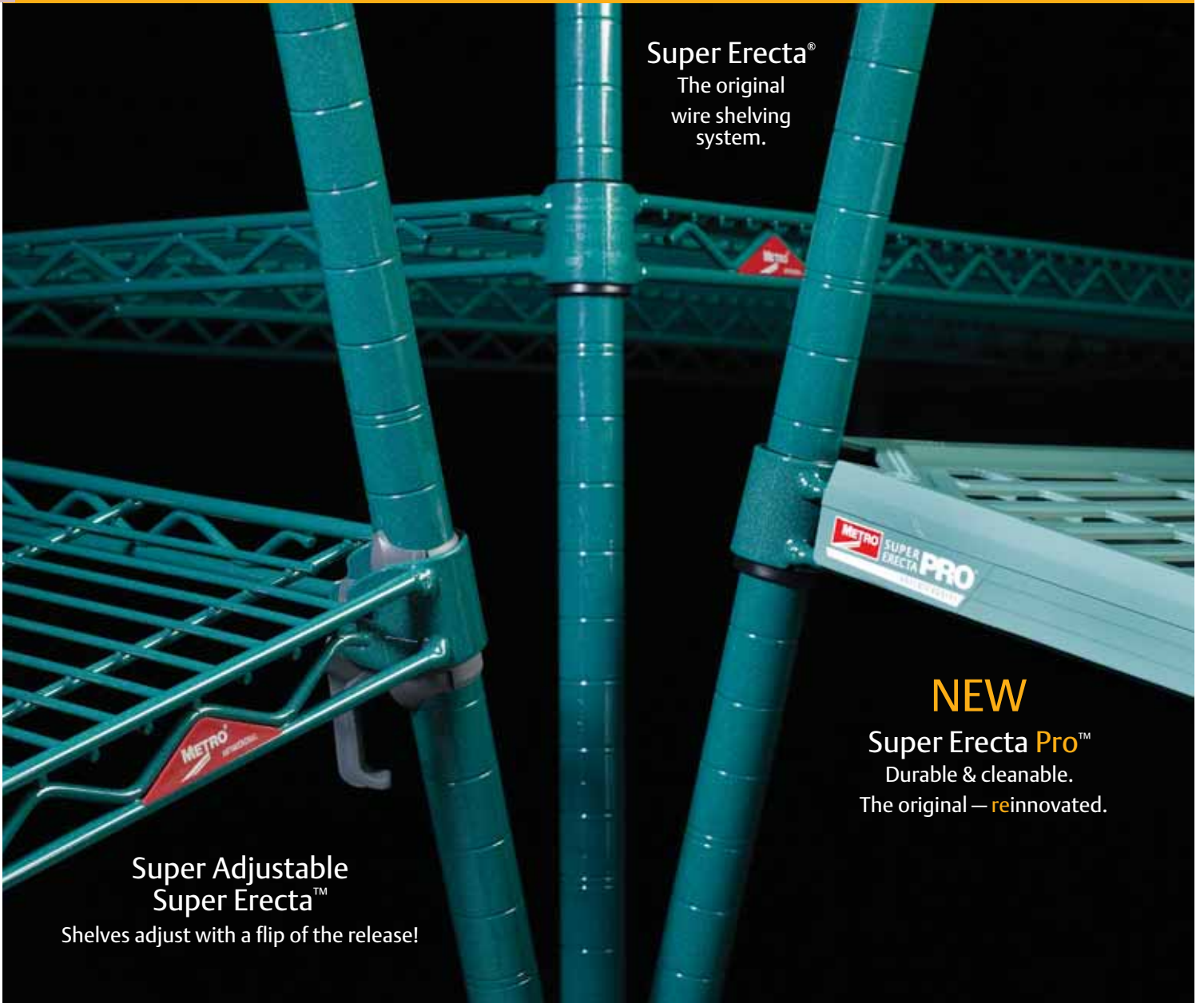

Super Erecta®  
The original  
wire shelving  
system.

**NEW**

Super Erecta Pro™  
Durable & cleanable.  
The original — reinnovated.

Super Adjustable  
Super Erecta™

Shelves adjust with a flip of the release!





# Progress.

Super Erecta Pro™  
Durable & cleanable.  
The original — reinnovated.



Epoxy coated Super Erecta-style frames with removable polymer shelf mats.

## Stays cleaner between cleanings.

Polymer shelf mats and Metroseal 3 epoxy coated shelf frames and posts have built-in Microban® antimicrobial product protection.



\*Microban® antimicrobial product protection helps keep shelves "cleaner between cleanings" by inhibiting the growth of bacteria, mold and mildew that cause odors and stains on the shelf surface. MICROBAN® and the MICROBAN® symbol are registered trademarks of the Microban Products Company, Huntersville, NC.



## Easy to clean.

Lift-off mats can be easily removed and washed by hand or in a wash machine.

## Prolonged durability.

Polymer shelf mats withstand daily abuse from containers and sharp edges. Robust design provides the strength and rigidity of Super Erecta...holds up to 800 lbs. (363kg) per shelf.



## Interchangeable.

Super Erecta Pro shelves can be configured with traditional shelf and accessory options on the same unit for maximum flexibility.

Super Erecta Pro™ Shelving — 10.80



Super Erecta Pro™ Shelves

Packaging: Shelves are priced individually and packaged no more than 4 per carton except 60" (1524mm) and 72" (1829mm) lengths which are packaged no more than 2 per carton. Plastic split sleeves are included with each shelf.

Nominal Width/Length (in.) (mm)		Approx. Pkd. Wt. (lbs.) (kg)		Cat. No. Super Erecta Pro Metroseal 3
18x24	457x610	6.0	2.7	PR1824NK3
18x30	457x760	7.8	3.5	PR1830NK3
18x36	457x914	9.5	4.2	PR1836NK3
18x42	457x1060	11.3	5.0	PR1842NK3
18x48	457x1219	13.0	5.8	PR1848NK3
18x54	457x1372	14.8	6.6	PR1854NK3
18x60	457x1524	16.5	7.4	PR1860NK3
18x72	457x1829	19.8	8.8	PR1872NK3
21x24	530x610	8.0	3.6	PR2124NK3
21x30	530x760	9.5	4.2	PR2130NK3
21x36	530x914	11.3	5.0	PR2136NK3
21x42	530x1060	12.5	5.6	PR2142NK3
21x48	530x1219	14.3	6.4	PR2148NK3
21x54	530x1372	16.5	7.4	PR2154NK3
21x60	530x1524	18.3	8.1	PR2160NK3
21x72	530x1829	21.5	9.6	PR2172NK3
24x24	610x610	9.5	4.2	PR2424NK3
24x30	610x760	11.3	5.0	PR2430NK3
24x36	610x914	13.0	5.8	PR2436NK3
24x42	610x1060	14.0	6.3	PR2442NK3
24x48	610x1219	15.5	6.9	PR2448NK3
24x54	610x1372	18.3	8.1	PR2454NK3
24x60	610x1524	20.0	8.9	PR2460NK3
24x72	610x1829	23.3	10.4	PR2472NK3

Note: Each Super Erecta Pro™ shelf up to and including 48" (1219mm) long have a maximum weight capacity of 800 lbs. (363kg) evenly distributed. Shelves longer than 48" (1219mm) have a maximum weight capacity of 600 lbs. (363kg) evenly distributed.

Super Erecta with Metroseal 3™ — Standard Shelves

Nominal Width/Length (in.) (mm)		Approx. Pkd. Wt. (lbs.) (kg)		Cat. No. Super Adjustable Metroseal 3	Cat. No. Super Erecta Metroseal 3	Approx. Pkd. Wt. (lbs.) (kg)		Cat. No. Dunnage Shelf Metroseal 3
18x24	457x610	7	3.2	A1824NK3	1824NK3	14	6.3	1824DRK3
18x30	457x760	8	3.6	A1830NK3	1830NK3	18	8.1	1830DRK3
18x36	457x914	9.5	4.3	A1836NK3	1836NK3	21	9.4	1836DRK3
18x42	457x1060	11	5.0	A1842NK3	1842NK3			—
18x48	457x1219	12	5.4	A1848NK3	1848NK3	28	12.6	1848DRK3
18x54	457x1372	14.5	6.6	A1854NK3	1854NK3			—
18x60	457x1524	17	7.7	A1860NK3	1860NK3	34	15.3	1860DRK3
18x72	457x1829	20	9.1	A1872NK3	1872NK3			—
21x24	530x610	8	3.6	A2124NK3	2124NK3			—
21x30	530x760	9	4.1	A2130NK3	2130NK3			—
21x36	530x914	11	5.0	A2136NK3	2136NK3			—
21x42	530x1060	12	5.4	A2142NK3	2142NK3			—
21x48	530x1219	14	6.4	A2148NK3	2148NK3			—
21x54	530x1372	16	7.3	A2154NK3	2154NK3			—
21x60	530x1524	18	8.2	A2160NK3	2160NK3			—
21x72	530x1829	24	10.9	A2172NK3	2172NK3			—
24x24	610x610	9	4.1	A2424NK3	2424NK3	16	7.2	2424DRK3
24x30	610x760	11	5.0	A2430NK3	2430NK3	20	9.0	2430DRK3
24x36	610x914	13	5.9	A2436NK3	2436NK3	24	10.8	2436DRK3
24x42	610x1060	15	6.8	A2442NK3	2442NK3			—
24x48	610x1219	16	7.3	A2448NK3	2448NK3	30	13.5	2448DRK3
24x54	610x1372	19	8.6	A2454NK3	2454NK3			—
24x60	610x1524	21	9.5	A2460NK3	2460NK3	37	16.6	2460DRK3
24x72	610x1829	26	11.8	A2472NK3	2472NK3			—

Actual Dimensions: Width: Add 1/4" (6mm) to nominal size. Length: Subtract 1/4" (6mm) from nominal size.

Super Erecta Pro shelves are also compatible on the same shelving units with the following Super Erecta items:

- Solid Shelves page 65
- Cantilever Shelves page 45
- SmartWall G3 page 72
- Post Type Wall Mounts page 79
- Direct Mount Shelf Supports page 80
- Three sided frames page 55
- Enclosure Panels page 54
- Security Units page 99
- Top Track page 92
- qwikTRAK page 90



Super Erecta Pro™ Shelving — 10.80

SiteSelect™ Posts

Stationary Super Erecta SiteSelect posts are fitted with adjustable leveling bolts to compensate for uneven surfaces. Mobile posts come without leveling bolt assembly to accommodate stem casters. Special length posts are available. See page 48 for stem caster options.



Stationary						Mobile					
Height		Approx. Pkd. Wt.		Cat. No.	Cat. No.	Height		Approx. Pkd. Wt.		Cat. No.	Cat. No.
(in.)	(mm)	(lbs.)	(kg)	Metroseal 3	Stainless	(in.)	(mm)	(lbs.)	(kg)	Metroseal 3	Stainless
14 <sup>1</sup> / <sub>2</sub>	370	1	0.5	13PK3	13PS	13 <sup>3</sup> / <sub>4</sub>	349	1	0.5	13UPK3	13UPS
34 <sup>1</sup> / <sub>2</sub>	875	2	0.9	33PK3	33PS	33 <sup>3</sup> / <sub>4</sub>	857	2	0.9	33UPK3	33UPS
54 <sup>9</sup> / <sub>16</sub>	1385	3	1.4	54PK3	54PS	53 <sup>13</sup> / <sub>16</sub>	1366	3	1.4	54UPK3	54UPS
62 <sup>9</sup> / <sub>16</sub>	1590	3 <sup>1</sup> / <sub>2</sub>	1.6	63PK3	63PS	61 <sup>13</sup> / <sub>16</sub>	1570	3 <sup>1</sup> / <sub>2</sub>	1.6	63UPK3	63UPS
74 <sup>5</sup> / <sub>8</sub>	1895	4	1.8	74PK3	74PS	69 <sup>3</sup> / <sub>4</sub>	1772	3.8	1.7	70UPK3	—
86 <sup>5</sup> / <sub>8</sub>	2200	5	2.3	86PK3	86PS	73 <sup>7</sup> / <sub>8</sub>	1876	4	1.8	74UPK3	74UPS
						85 <sup>7</sup> / <sub>8</sub>	2181	5	2.3	86UPK3	86UPS

Accessories — 10.81

**Note:** These accessories are designed to attach to a Super Erecta Pro Shelf. Accessories for basic Super Erecta wire shelves can be found on pages 53-60. For a complete list of compatible accessories for Super Erecta Pro shelves, please refer to spec sheet 10.81 for more information.

“S” Hooks

Eliminates the need for adjacent posts.

Two required for each storage level.

Cat. No. **Q9995Z**

Universal Divider

- Corrosion proof

Nominal Length		Fits Shelf Depth		Approx. Pkd. Wt.		Cat. No.
(in.)	(mm)	(in.)	(mm)	(lbs.)	(kg)	
18	457	18", 21"	(457, 530mm)	1.3	0.6	<b>MUD18-8</b>
24	610	24"	(610mm)	1.6	0.7	<b>MUD24-8</b>

Shelf-to-Shelf Divider

- Connects between two shelves
- Corrosion proof

Nominal Height		Compatible with Shelf Depths		Approx. Pkd. Wt.		Cat. No.
(in.)	(mm)	(in.)	(mm)	(lbs.)	(kg)	
16	406	18, 21	457, 530	2.3	1.0	<b>MD18-16</b>
20	508	18, 21	457, 530	2.5	1.1	<b>MD18-20</b>
24	610	18, 21	457, 530	3.8	1.7	<b>MD18-24</b>
16	406	24	610	2.8	1.2	<b>MD24-16</b>
20	508	24	610	3.0	1.3	<b>MD24-20</b>
24	610	24	610	4.4	2.0	<b>MD24-24</b>

Color Shelf Marker

- 6" (152mm) Length
- Fits Super Erecta Pro Shelf
- Attach easily to shelf to identify contents stored.

Color	Length		Approx. Pkd. Wt.		Cat. No.
	(in.)	(mm)	(lbs.)	(kg)	
Blue	6	152	0.05	0.02	<b>CSM6-BQ</b>
Green	6	152	0.05	0.02	<b>CSM6-GQ</b>
Red	6	152	0.05	0.02	<b>CSM6-RQ</b>
Tan	6	152	0.05	0.02	<b>CSM6-TQ</b>
White	6	152	0.05	0.02	<b>CSM6-WQ</b>
Yellow	6	152	0.05	0.02	<b>CSM6-YQ</b>
Gray	6	152	0.05	0.02	<b>CSM6-GRQ</b>

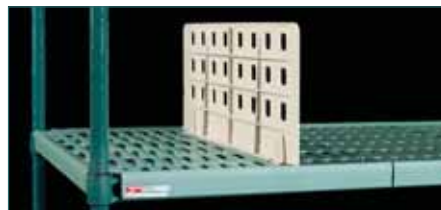

Label Holders

- Fits Super Erecta Pro Shelf
- Plastic holders snap into place to accommodate 1" (25mm) tall adhesive label.

Cat. No. **Q04LH**



# Reclaim Wasted Space.



Super Adjustable™  
Super Erecta® Shelving

Adjust and add shelves quickly and easily to reclaim wasted space.



Super Erecta

Easy “no-tool”  
shelf adjustment

1" (25mm)  
spacing minimizes  
dead space

Efficient use of space  
allows more storage  
levels to be added.

**Storage efficiency  
can increase  
by 25% or more**



Super Adjustable  
Super Erecta



# SUPER ADJUSTABLE SUPER ERECTA® SHELVING

## Super Adjustable Wire Shelves — 10.01a 10.10a

Packaging: Wire shelves are priced individually and packaged no more than 4 per carton except 60" (1524mm) and 72" (1829mm) lengths and 30" (760mm) and 36" (914mm) widths, which are packaged no more than 2 per carton. Plastic sleeves and wedges are included with each shelf.

Width/Length (in.) (mm)	Approx. Pkd. Wt. (lbs.) (kg)	Cat. No. Chrome	Cat. No. Metroseal 3 with Microban®	Cat. No. Stainless
14x24 355x610	6 2.7	A1424NC	A1424NK3	A1424NS
14x30 355x760	7 3.2	A1430NC	A1430NK3	A1430NS
14x36 355x914	8 3.6	A1436NC	A1436NK3	A1436NS
14x42 355x1066	9 1/2 4.3	A1442NC	A1442NK3	A1442NS
14x48 355x1219	10 1/2 4.7	A1448NC	A1448NK3	A1448NS
14x60 355x1524	14 6.3	A1460NC	A1460NK3	A1460NS
14x72 355x1825	17 7.7	A1472NC	A1472NK3	A1472NS
18x24 457x610	7 3.2	A1824NC	A1824NK3	A1824NS
18x30 457x760	8 3.6	A1830NC	A1830NK3	A1830NS
18x36 457x914	9 1/2 4.3	A1836NC	A1836NK3	A1836NS
18x42 457x1066	11 5.0	A1842NC	A1842NK3	A1842NS
18x48 457x1219	12 5.4	A1848NC	A1848NK3	A1848NS
18x54 457x1370	14 1/2 6.6	A1854NC	A1854NK3	A1854NS
18x60 457x1524	17 7.7	A1860NC	A1860NK3	A1860NS
18x72 457x1829	20 9.1	A1872NC	A1872NK3	A1872NS
21x24 530x610	8 3.6	A2124NC	A2124NK3	A2124NS
21x30 530x760	9 4.1	A2130NC	A2130NK3	A2130NS
21x36 530x914	11 5.0	A2136NC	A2136NK3	A2136NS
21x42 530x1066	12 5.4	A2142NC	A2142NK3	A2142NS
21x48 530x1219	14 6.4	A2148NC	A2148NK3	A2148NS
21x54 530x1370	16 7.3	A2154NC	A2154NK3	A2154NS
21x60 530x1524	18 8.2	A2160NC	A2160NK3	A2160NS
21x72 530x1829	24 10.9	A2172NC	A2172NK3	A2172NS
24x24 610x610	9 4.1	A2424NC	A2424NK3	A2424NS
24x30 610x760	11 5.0	A2430NC	A2430NK3	A2430NS
24x36 610x914	13 5.9	A2436NC	A2436NK3	A2436NS
24x42 610x1066	15 6.8	A2442NC	A2442NK3	A2442NS
24x48 610x1219	16 7.3	A2448NC	A2448NK3	A2448NS
24x54 610x1370	18 8.6	A2454NC	A2454NK3	A2454NS
24x60 610x1524	21 9.5	A2460NC	A2460NK3	A2460NS
24x72 610x1829	26 11.8	A2472NC	A2472NK3	A2472NS
30x36 760x914	15 6.8	A3036NC		A3036NS
30x48 760x1219	21 9.5	A3048NC		A3048NS
30x60 760x1524	26 1/2 11.8	A3060NC		A3060NS
30x72 760x1829	31 14.0	A3072NC		A3072NS
36x36 910x914	18 8.2	A3636NC		A3636NS
36x48 910x1219	23 10.4	A3648NC		A3648NS
36x60 910x1524	29 13.1	A3660NC		A3660NS
36x72 910x1829	34 1/2 15.4	A3672NC		A3672NS

Note: For availability of Super Adjustable Shelving not listed above, contact your Metro representative.

## SiteSelect™ Posts — 10.01a 10.10a

Stationary Super Erecta® SiteSelect posts are fitted with adjustable leveling bolts to compensate for uneven surfaces. Mobile posts come without leveling bolt assembly to accommodate stem casters. Special length posts are available.†

STATIONARY					MOBILE			
Height* (in.) (mm)	Approx. Pkd. Wt. (lbs.) (kg)	Cat. No. Chrome	Cat. No. Metroseal 3 with Microban®	Cat. No. Stainless**	Approx. Pkd. Wt. (lbs.) (kg)	Cat. No. Plated	Cat. No. Metroseal 3 with Microban®	Cat. No. Stainless
7 1/2 191	1/2 0.3	7P						
14 1/2 370	1 0.5	13P	13PK3	13PS	1 0.5	13UP	13UPK3	13UPS
27 1/2 699	1 3/4 0.75	27P		27PS	1 3/4 0.75	27UP		27UPS
34 1/2 875	2 0.9	33P	33PK3	33PS	2 0.9	33UP	33UPK3	33UPS
54 9/16 1385	3 1.4	54P	54PK3	54PS	3 1.4	54UP	54UPK3	54UPS
62 9/16 1590	3 1/2 1.6	63P	63PK3	63PS	3 1/2 1.6	63UP	63UPK3	63UPS
74 5/8 1895	4 1.8	74P	74PK3	74PS	3 3/4 1.7		70UPK3	
86 5/8 2200	5 2.3	86P	86PK3	86PS	4 1.8	74UP	74UPK3	74UPS
96 5/8 2454	5 1/2 2.5	***96P			4.5 2.0	86UP	86UPK3	86UPS

\*Height includes leveling bolt and cap.

\*\*Stainless stationary post includes stainless leveling bolt.

\*\*\*96P should not be used on units less than 24" (610mm) deep. Consult Metro Engineering for alternate recommendations.

†Note: Special length posts are available, priced at next higher length plus a cutting charge.

Post lengths to be specified as cut to a round number, ie: 74P cut to 69" (1753mm) . . . This will result in an overall post height with adjustment of 69 3/8" (1762mm) to 69 5/8" (1775mm).

\*MICROBAN® and the MICROBAN® symbol are registered trademarks of the Microban Products Company, Huntersville, NC. Indicates antimicrobial product.



**Shelving Starter and Add-On Units**

Save time and money by eliminating adjacent posts and replacing with "S" hooks.

- Starter Units consist of four posts and indicated number of Super Adjustable Super Erecta shelves.
- Add-On Units consist of two posts, indicated number of shelves, and two "S" Hooks per shelf, for attaching shelf to adjacent unit.



**Replacement "S" Hook**  
2 are required for each storage level.  
Cat. No. **9995Z**

For additional wire shelves, order from page 37.

Add-on units with "S" hooks can only be attached to shelves supported by two or more posts.



**Security "S" Hook**  
2 are required for each storage level.  
Chrome. Cat. No. **H9995C**  
Bag of 2  
Black. Cat. No. **H9995B**  
Bag of 2

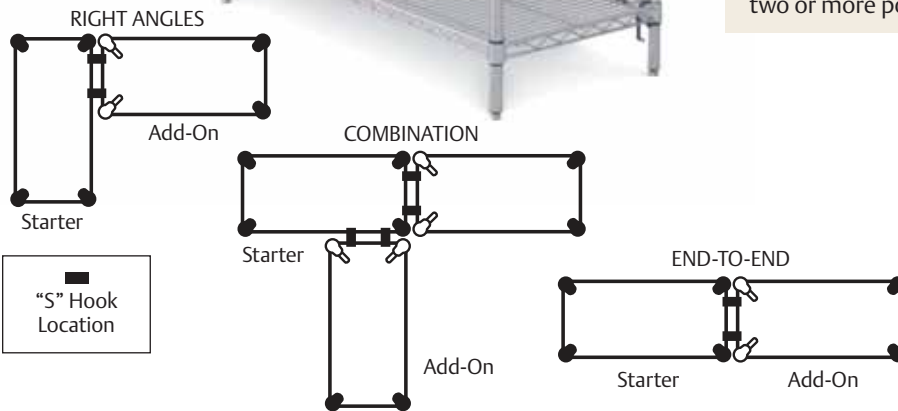

Indicates antimicrobial product.

**Shelving Starter and Add-On Units — Easy Order Guide**

	Chrome-Plated						Metroseal 3 with Microban®												
	5 Shelves 74" (1880mm) Posts (74P)		18" (457mm) Wide		21" (530mm) Wide		24" (610mm) Wide		5 Shelves 74" (1880mm) Posts (74PK3)		18" (457mm) Wide		21" (530mm) Wide		24" (610mm) Wide				
	Starter	Add-On	Starter	Add-On	Starter	Add-On	Starter	Add-On	Starter	Add-On	Starter	Add-On	Starter	Add-On	Starter	Add-On			
<b>24"</b> (610mm)	5A317C	5AA317C	5A417C	5AA417C	5A517C	5AA517C	5A317K3	5AA317K3	5A417K3	5AA417K3	5A517K3	5AA517K3	5A317K3	5AA317K3	5A417K3	5AA417K3	5A517K3	5AA517K3	
<b>Long</b>	Wt. lbs. (kg)	51 (23)	43 (20)	57 (26)	48 (22)	62 (28)	53 (24)	51 (23)	43 (20)	57 (26)	48 (22)	62 (28)	53 (24)	51 (23)	43 (20)	57 (26)	48 (22)	62 (28)	53 (24)
<b>30"</b> (760mm)	5A327C	5AA327C	5A427C	5AA427C	5A527C	5AA527C	5A327K3	5AA327K3	5A427K3	5AA427K3	5A527K3	5AA527K3	5A327K3	5AA327K3	5A427K3	5AA427K3	5A527K3	5AA527K3	
<b>Long</b>	Wt. lbs. (kg)	58 (26)	50 (23)	64 (29)	56 (25)	71 (32)	62 (28)	58 (26)	50 (23)	64 (29)	56 (25)	71 (32)	62 (28)	58 (26)	50 (23)	64 (29)	56 (25)	71 (32)	62 (28)
<b>36"</b> (914mm)	5A337C	5AA337C	5A437C	5AA437C	5A537C	5AA537C	5A337K3	5AA337K3	5A437K3	5AA437K3	5A537K3	5AA537K3	5A337K3	5AA337K3	5A437K3	5AA437K3	5A537K3	5AA537K3	
<b>Long</b>	Wt. lbs. (kg)	65 (29)	57 (26)	73 (33)	65 (29)	81 (37)	73 (33)	65 (29)	57 (26)	73 (33)	65 (29)	81 (37)	73 (33)	65 (29)	57 (26)	73 (33)	65 (29)	81 (37)	73 (33)
<b>42"</b> (1066mm)	5A347C	5AA347C	5A447C	5AA447C	5A547C	5AA547C	5A347K3	5AA347K3	5A447K3	5AA447K3	5A547K3	5AA547K3	5A347K3	5AA347K3	5A447K3	5AA447K3	5A547K3	5AA547K3	
<b>Long</b>	Wt. lbs. (kg)	70 (32)	62 (28)	81 (37)	73 (33)	89 (40)	81 (37)	70 (32)	62 (28)	81 (37)	73 (33)	89 (40)	81 (37)	70 (32)	62 (28)	81 (37)	73 (33)	89 (40)	81 (37)
<b>48"</b> (1219mm)	5A357C	5AA357C	5A457C	5AA457C	5A557C	5AA557C	5A357K3	5AA357K3	5A457K3	5AA457K3	5A557K3	5AA557K3	5A357K3	5AA357K3	5A457K3	5AA457K3	5A557K3	5AA557K3	
<b>Long</b>	Wt. lbs. (kg)	78 (35)	70 (32)	88 (40)	80 (36)	98 (44)	90 (41)	78 (35)	70 (32)	88 (40)	80 (36)	98 (44)	90 (41)	78 (35)	70 (32)	88 (40)	80 (36)	98 (44)	90 (41)
<b>60"</b> (1524mm)	5A367C	5AA367C	5A467C	5AA467C	5A567C	5AA567C	5A367K3	5AA367K3	5A467K3	5AA467K3	5A567K3	5AA567K3	5A367K3	5AA367K3	5A467K3	5AA467K3	5A567K3	5AA567K3	
<b>Long</b>	Wt. lbs. (kg)	102 (46)	93 (42)	109 (49)	101 (46)	122 (55)	113 (51)	102 (46)	93 (42)	109 (49)	101 (46)	122 (55)	113 (51)	102 (46)	93 (42)	109 (49)	101 (46)	122 (55)	113 (51)
<b>72"</b> (1829mm)	5A377C	5AA377C	5A477C	5AA477C	5A577C	5AA577C	5A377K3	5AA377K3	5A477K3	5AA477K3	5A577K3	5AA577K3	5A377K3	5AA377K3	5A477K3	5AA477K3	5A577K3	5AA577K3	
<b>Long</b>	Wt. lbs. (kg)	117 (53)	108 (49)	122 (55)	113 (51)	149 (68)	141 (64)	117 (53)	108 (49)	122 (55)	113 (51)	149 (68)	141 (64)	117 (53)	108 (49)	122 (55)	113 (51)	149 (68)	141 (64)

Super Adjustable Super Erecta® Stem Caster Carts — **11.01a**

- Four- and five-tier models available.
- Consists of Super Adjustable Super Erecta wire shelves.
- 5" (127mm) resilient rubber or polyurethane casters with donut bumpers.
- Super Adjustable Super Erecta shelves allow for quick and easy adjustability.
- Open-wire shelf design minimizes dust and increases air circulation and visibility.
- Strong and versatile. (See Metro Fact below)
- For additional storage levels, Super Adjustable shelves may be added as desired. (See page 37.)



Super Adjustable Super Erecta® Wire Stem Caster Cart

**Metro Fact:**  
Carts with polyurethane casters are designed to hold up to 900 lbs. (408kg). Carts with rubber casters can hold up to 600 lbs. (272kg) of evenly distributed weight. Heavier weight loads should be stored as low as possible on cart for safe maneuverability.



Lift the release at each corner to adjust Super Adjustable shelves at 1" (25mm) increments in seconds.

Use a solid shelf on the lowest levels to protect contents on the bottom of the cart from debris and dripping. (See page 65).

**4-Tier Models**

With Chrome Shelves and Chrome-Plated Posts  
63" (1600mm) Posts — Overall Height 69" (1753mm)

Shelf Width/Length (in.)	Shelf Width/Length (mm)	Approx. Pkd. Wt. (lbs.)	Approx. Pkd. Wt. (kg)	Catalog Number with Casters	
				Two Swivel Two Brake Resilient Rubber Casters	Two Swivel Two Brake Polyurethane Casters
18x36	457x914	60	27	<b>A336BC</b>	<b>A336EC</b>
18x48	457x1219	72	32	<b>A356BC</b>	<b>A356EC</b>
18x60	457x1524	88	40	<b>A366BC</b>	<b>A366EC</b>
21x36	530x914	69	31	<b>A436BC</b>	<b>A436EC</b>
21x48	530x1219	81	36	<b>A456BC</b>	<b>A456EC</b>
21x60	530x1524	98	44	<b>A466BC</b>	<b>A466EC</b>
24x36	610x914	76	34	<b>A536BC</b>	<b>A536EC</b>
24x48	610x1219	92	41	<b>A556BC</b>	<b>A556EC</b>
24x60	610x1524	112	51	<b>A566BC</b>	<b>A566EC</b>

**5-Tier Models**

With Chrome Shelves and Chrome-Plated Posts  
63" (1600mm) Posts — Overall Height 69" (1753mm)

Shelf Width/Length (in.)	Shelf Width/Length (mm)	Approx. Pkd. Wt. (lbs.)	Approx. Pkd. Wt. (kg)	Catalog Number with Casters	
				Two Swivel Two Brake Resilient Rubber Casters	Two Swivel Two Brake Polyurethane Casters
18x36	457x914	60	27	<b>5A336BC</b>	<b>5A336EC</b>
18x48	457x1219	72	32	<b>5A356BC</b>	<b>5A356EC</b>
18x60	457x1524	88	40	<b>5A366BC</b>	<b>5A366EC</b>
21x36	530x914	69	31	<b>5A436BC</b>	<b>5A436EC</b>
21x48	530x1219	81	36	<b>5A456BC</b>	<b>5A456EC</b>
21x60	530x1524	98	44	<b>5A466BC</b>	<b>5A466EC</b>
24x36	610x914	76	34	<b>5A536BC</b>	<b>5A536EC</b>
24x48	610x1219	92	41	<b>5A556BC</b>	<b>5A556EC</b>
24x60	610x1524	112	51	<b>5A566BC</b>	<b>5A566EC</b>

# Genuine Quality.

Genuine Metro!

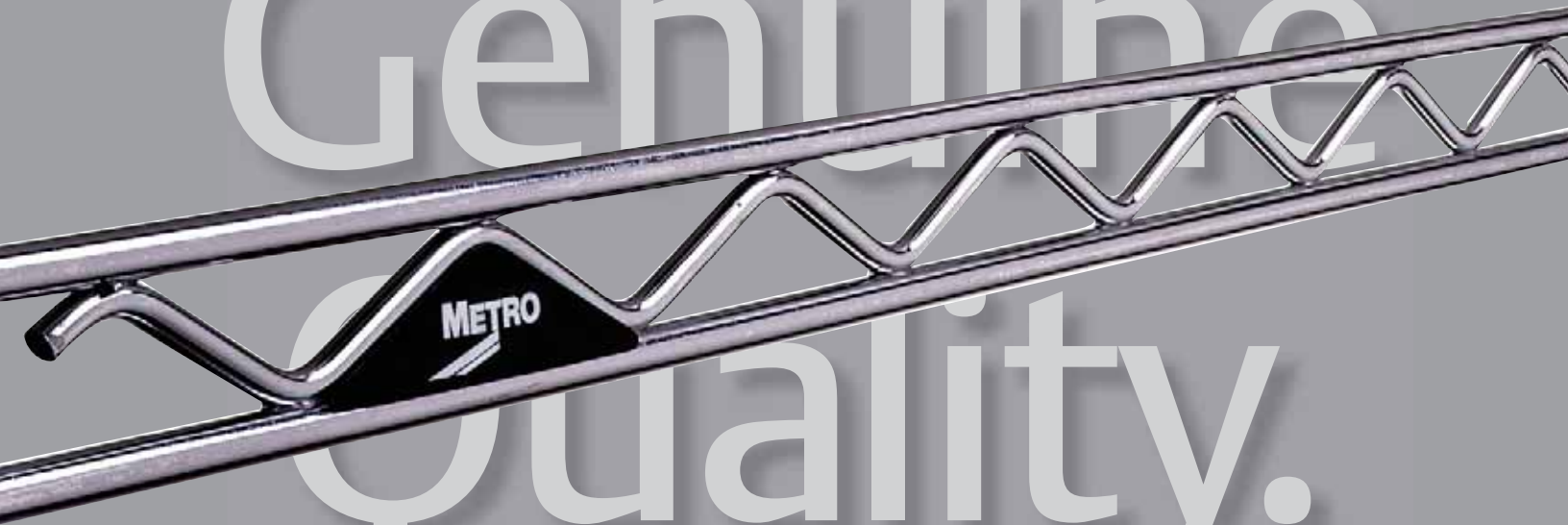

## Super Erecta® Shelving System The original wire storage system.

A storage system that defines the extent of space, Super Erecta's revolutionary concept was fresh and innovative from its start — nearly 30 years ago. It has continued to evolve, with nearly 100 highly specialized accessories, aimed at meeting the diversity of today's challenges.

- Adjustable: Shelves can be repositioned at precise 1" (25mm) increments along the length of the numbered posts.
- Unique Design: Open-wire design minimizes dust accumulation, allows a free circulation of air, and greater visibility of stored items.
- Mobile: Full choice of caster types available for mobile applications.



### Metro Fact:

#### Genuine Metro!

Metro created the original post-based shelving unit in 1965. Still today, Metro Super Erecta Shelving is recognized worldwide as the most popular commercial shelving system ever.



# Strong to the Finish.

## Shelving Finishes Guide

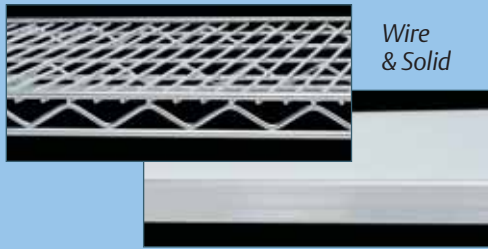

Wire & Solid

### Type 304 Polished Stainless Steel

Addresses the most aggressive applications and environments. All-stainless solid and wire options exist for high temperature automated cart wash and autoclave applications.



### Metroseal 3™ Epoxy

Corrosion resistant finish for wet or high humidity environments with a 12 year warranty against rust and corrosion. Microban antimicrobial is built into the finish to keep the product “cleaner between cleanings”.

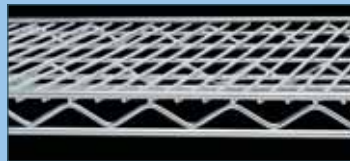

### Chrome Plating

The “real” nickel-chrome finish for dry, low humidity environments. Metro’s durable chrome finish includes a protective lacquer coat.



### Brite

Economical, chromate finish for dry, low humidity environments. Metro’s Brite finish provides the look of chrome and includes a protective lacquer coat.



## Standard Epoxy and Designer Finishes

A pleasing aesthetic and basic protection for dry environments.



## Shelving Post Guide

**Standard Stationary Post** with adjustable leveling foot. Stainless models also feature a stainless leveling foot. Use Foot Plates for greater stability.

**Standard Stem Caster Mobile Post** accepts a Metro stem caster. Use these for the majority of standard duty transport and movable storage applications.

### Cart Wash and Autoclave Applications

Swaged stainless post has a fastened aluminum post cap and is specifically designed to withstand high temperatures. See page 48 for part numbers.

### Heavy Duty Transport

Staked post attaches to a dolly truck to address abusive transport applications. The reinforced connection between the base receptacle and post provides a more secure connection to the dolly truck. See page 50 for part numbers.

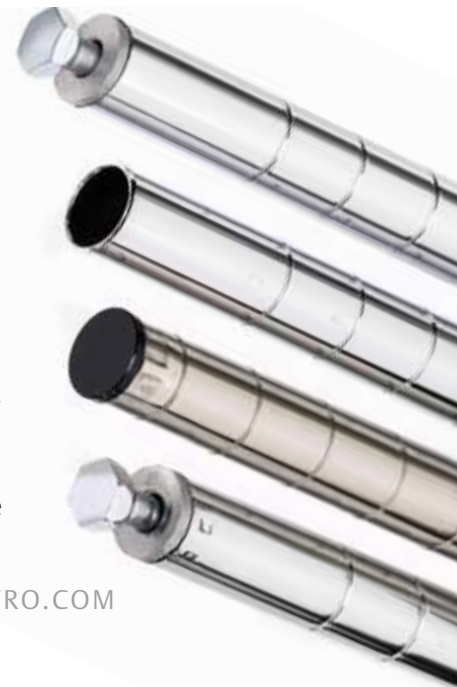



Wire Shelves — 10.01a 10.10a

Packaging: Wire shelves are priced individually and packaged no more than 4 per carton except 60" (1524mm) and 72" (1829mm) lengths and 30" (760mm) and 36" (914mm) widths, which are packaged no more than 2 per carton. Plastic sleeves and wedges are included with each shelf.

Width/Length (in.)	Width/Length (mm)	Approx. Pkd. Wt. (lbs.)	Pkd. Wt. (kg)	Cat. No. Super Erecta Brite	Cat. No. Chrome	Cat. No. Metroseal 3 with Microban®	Cat. No. Stainless
14x24	355x610	6	2.7	1424BR	1424NC	1424NK3	1424NS
14x30	355x760	7	3.2	1430BR	1430NC	1430NK3	1430NS
14x36	355x914	8	3.6	1436BR	1436NC	1436NK3	1436NS
14x42	355x1066	9½	4.3	1442BR	1442NC	1442NK3	1442NS
14x48	355x1219	10½	4.7	1448BR	1448NC	1448NK3	1448NS
14x60	355x1524	14	6.3	1460BR	1460NC	1460NK3	1460NS
14x72	355x1829	17	7.7	1472BR	1472NC	1472NK3	1472NS
18x18	457x457	6	2.7	N/A	1818NC	N/A	N/A
18x24	457x610	7	3.2	1824BR	1824NC	1824NK3	1824NS
18x30	457x760	8	3.6	1830BR	1830NC	1830NK3	1830NS
18x36	457x914	9½	4.3	1836BR	1836NC	1836NK3	1836NS
18x42	457x1066	11	5.0	1842BR	1842NC	1842NK3	1842NS
18x48	457x1219	12	5.4	1848BR	1848NC	1848NK3	1848NS
18x54	457x1370	14½	6.6	1854BR	1854NC	1854NK3	1854NS
18x60	457x1524	17	7.7	1860BR	1860NC	1860NK3	1860NS
18x72	457x1829	20	9.1	1872BR	1872NC	1872NK3	1872NS
21x24	530x610	8	3.6	2124BR	2124NC	2124NK3	2124NS
21x30	530x760	9	4.1	2130BR	2130NC	2130NK3	2130NS
21x36	530x914	11	5.0	2136BR	2136NC	2136NK3	2136NS
21x42	530x1066	12	5.4	2142BR	2142NC	2142NK3	2142NS
21x48	530x1219	14	6.4	2148BR	2148NC	2148NK3	2148NS
21x54	530x1370	16	7.3	2154BR	2154NC	2154NK3	2154NS
21x60	530x1524	18	8.2	2160BR	2160NC	2160NK3	2160NS
21x72	530x1829	24	10.9	2172BR	2172NC	2172NK3	2172NS
24x24	610x610	9	4.1	2424BR	2424NC	2424NK3	2424NS
24x30	610x760	11	5.0	2430BR	2430NC	2430NK3	2430NS
24x36	610x914	13	5.9	2436BR	2436NC	2436NK3	2436NS
24x42	610x1066	15	6.8	2442BR	2442NC	2442NK3	2442NS
24x48	610x1219	16	7.3	2448BR	2448NC	2448NK3	2448NS
24x54	610x1370	19	8.6	2454BR	2454NC	2454NK3	2454NS
24x60	610x1524	21	9.5	2460BR	2460NC	2460NK3	2460NS
24x72	610x1829	26	11.8	2472BR	2472NC	2472NK3	2472NS
30x36	760x914	15	6.8		3036NC	3036NK3	3036NS
30x48	760x1219	21	9.5		3048NC	3048NK3	3048NS
30x60	760x1524	26½	11.8		3060NC	3060NK3	3060NS
30x72	760x1829	31	14.0		3072NC	3072NK3	3072NS
36x36	910x914	18	8.2		3636NC	3636NK3	3636NS
36x48	910x1219	23	10.4		3648NC	3648NK3	3648NS
36x60	910x1524	29	13.1		3660NC	3660NK3	3660NS
36x72	910x1829	34½	15.4		3672NC	3672NK3	3672NS

**Note:** With 14" (355mm) shelving, foot plates must be used on freestanding units; on mobile units, maximum post height is 54" (1370mm). It is not recommended to use 14" (355mm) shelving with posts higher than 74" (1880mm).  
**Note:** The actual length of the shelves is 1/8" (3.2mm) shorter than the nominal dimension shown. The actual depth of the shelves is 1/8" (3.2mm) greater than the nominal dimension shown.  
**Note:** Metroseal 3 is not cart-washable.  
**Note:** Super Erecta wire shelves up to 24" (610mm) deep and 48" (1219mm) long can hold up to 800 lbs. (363kg) per shelf evenly distributed. Shelves up to 24" deep and longer than 48" (1219mm) can hold up to 600 lbs. (272kg) per shelf evenly distributed.  
**Note:** 30" and 36" (760 and 910mm) deep Super Erecta wire shelves up to 48" (1219mm) long can hold up to 600 lbs. (272kg) per shelf evenly distributed. 30" and 36" (760 and 910mm) deep Super Erecta wire shelves longer than 48" (1219mm) can hold up to 400 lbs. (182kg) per shelf evenly distributed.

SiteSelect™ Posts

— 10.01a 10.10a

Stationary Super Erecta® SiteSelect posts are fitted with adjustable leveling bolts to compensate for uneven surfaces. Mobile posts come without leveling bolt assembly to accommodate stem casters. Special length posts are available.†

STATIONARY						MOBILE			
Height* (in.)	Height* (mm)	Approx. Pkd. Wt. (lbs.)	Pkd. Wt. (kg)	Cat. No. Chrome	Cat. No. Metroseal 3 with Microban®	Approx. Pkd. Wt. (lbs.)	Cat. No. Plated	Cat. No. Metroseal 3 with Microban®	Cat. No. Stainless
7½	191	½	0.3	7P					
14½	370	1	0.5	13P	13PK3	1	13UP	13UPK3	13UPS
27½	699	1¾	0.75	27P		1¾	27UP		27UPS
34½	875	2	0.9	33P	33PK3	2	33UP	33UPK3	33UPS
54 <sup>9</sup> / <sub>16</sub>	1385	3	1.4	54P	54PK3	3	54UP	54UPK3	54UPS
62 <sup>2</sup> / <sub>16</sub>	1590	3½	1.6	63P	63PK3	3½	63UP	63UPK3	63UPS
74 <sup>5</sup> / <sub>8</sub>	1895	4	1.8	74P	74PK3	3¾		70UPK3	
86 <sup>5</sup> / <sub>8</sub>	2200	5	2.3	86P	86PK3	4	74UP	74UPK3	74UPS
96 <sup>5</sup> / <sub>8</sub>	2454	5½	2.5	***96P		4.5	86UP	86UPK3	86UPS

\*Height includes leveling bolt and cap.  
 \*\*Stainless stationary post includes stainless leveling bolt.  
 \*\*\*96P should not be used on units less than 24" (610mm) deep. Consult Metro Engineering for alternate recommendations.  
 †Note: Special length posts are available, priced at next higher length plus a cutting charge. Post lengths to be specified as cut to a round number, ie: 74P cut to 69" (1753mm) . . . This will result in an overall post height with adjustment of 69<sup>3</sup>/<sub>8</sub>" (1762mm) to 69<sup>5</sup>/<sub>8</sub>" (1775mm).  
 Casters for mobile applications can be found on pages 48 & 49.

Indicates antimicrobial product.

Designer Color Shelving — 10.14

Available in a wide spectrum of colors that complement any decor.

Width/Length (in.) (mm)	Approx. Pkd. Wt. (lbs.) (kg)	STANDARD COLORS			DESIGNER COLORS			
		Cat. No. Black	Cat. No. White	Cat. No. Smoked Glass	Cat. No. Flame	Cat. No. Designer Colors*		
14x24	355x610	6	2.7	1424NBL	1424NW	1424N-DSG	1442NF	1424N-D
14x30	355x760	7	3.2	1430NBL	1430NW	1430N-DSG	1430NF	1430N-D
14x36	355x914	8	3.6	1436NBL	1436NW	1436N-DSG	1436NF	1436N-D
14x42	355x1066	9 1/2	4.3	1442NBL	1442NW	1442N-DSG	1442NF	1442N-D
14x48	355x1219	10 1/2	4.7	1448NBL	1448NW	1448N-DSG	1448NF	1448N-D
14x60	355x1524	14	6.3	1460NBL	1460NW	1460N-DSG	1460NF	1460N-D
14x72	355x1829	17	7.7	1472NBL	1472NW	1472N-DSG	1472NF	1472N-D
18x18	457x457	6	2.7	1818NBL	1818NW	1818N-DSG	1818NF	1818N-D
18x24	457x610	7	3.2	1824NBL	1824NW	1824N-DSG	1824NF	1824N-D
18x30	457x760	8	3.6	1830NBL	1830NW	1830N-DSG	1830NF	1830N-D
18x36	457x914	9 1/2	4.3	1836NBL	1836NW	1836N-DSG	1836NF	1836N-D
18x42	457x1066	11	5.0	1842NBL	1842NW	1842N-DSG	1842NF	1842N-D
18x48	457x1219	12	5.4	1848NBL	1848NW	1848N-DSG	1848NF	1848N-D
18x54	457x1370	14 1/2	6.6	1854NBL	1854NW	1854N-DSG	1854NF	1854N-D
18x60	457x1524	17	7.7	1860NBL	1860NW	1860N-DSG	1860NF	1860N-D
18x72	457x1829	20	9.1	1872NBL	1872NW	1872N-DSG	1872NF	1872N-D
21x24	530x610	8	3.6	2124NBL	2124NW	2124N-DSG	2124NF	2124N-D
21x30	530x760	9	4.1	2130NBL	2130NW	2130N-DSG	2130NF	2130N-D
21x36	530x914	11	5.0	2136NBL	2136NW	2136N-DSG	2136NF	2136N-D
21x42	530x1066	12	5.4	2142NBL	2142NW	2142N-DSG	2142NF	2142N-D
21x48	530x1219	14	6.4	2148NBL	2148NW	2148N-DSG	2148NF	2148N-D
21x54	530x1370	16	7.3	2154NBL	2154NW	2154N-DSG	2154NF	2154N-D
21x60	530x1524	18	8.2	2160NBL	2160NW	2160N-DSG	2160NF	2160N-D
21x72	530x1829	24	10.9	2172NBL	2172NW	2172N-DSG	2172NF	2172N-D
24x24	610x610	9	4.1	2424NBL	2424NW	2424N-DSG	2424NF	2424N-D
24x30	610x760	11	5.0	2430NBL	2430NW	2430N-DSG	2430NF	2430N-D
24x36	610x914	13	5.9	2436NBL	2436NW	2436N-DSG	2436NF	2436N-D
24x42	610x1066	15	6.8	2442NBL	2442NW	2442N-DSG	2442NF	2442N-D
24x48	610x1219	16	7.3	2448NBL	2448NW	2448N-DSG	2448NF	2448N-D
24x54	610x1370	19	8.6	2454NBL	2454NW	2454N-DSG	2454NF	2454N-D
24x60	610x1524	21	9.5	2460NBL	2460NW	2460N-DSG	2460NF	2460N-D
24x72	610x1829	26	11.8	2472NBL	2472NW	2472N-DSG	2472NF	2472N-D

Note: White epoxy Super Erecta shelves come with white split sleeves.  
 Note: All Black, Smoked Glass and Designer Super Erecta shelves come with black split sleeves.  
 Note: Black shelving is NSF listed. White, Smoked Glass, and Designer Colors are not NSF listed.

Posts — 10.14

Height* (in.) (mm)	Approx. Pkd. Wt. (lbs.) (kg)	STATIONARY					MOBILE (FOR STEM CASTERS)								
		Cat. No. Black	Cat. No. White	Cat. No. Smoked Glass	Cat. No. Flame	Cat.No. Designer Colors*	Cat. No. Black	Cat. No. White	Cat. No. Smoked Glass	Cat. No. Flame	Cat. No. Designer Colors*				
7 1/2	191	1/2	0.3	7PBL	7PW	7P-DSG	7PF	7P-D	—	—	—	—	—		
14 1/2	370	1	0.5	13PBL	13PW	13P-DSG	13PF	13P-D	—	—	—	—	—		
27 1/2	699	1 3/4	0.75	27PBL	27PW	27P-DSG	27PF	27P-D	1 3/4	0.75	27UPBL	27UPW	27UP-DSG	27UPF	27UP-D
34 1/2	875	2	0.9	33PBL	33PW	33P-DSG	33PF	33P-D	2	0.9	33UPBL	33UPW	33UP-DSG	33UPF	33UP-D
54 9/16	1385	3	1.4	54PBL	54PW	54P-DSG	54PF	54P-D	3	1.4	54UPBL	54UPW	54UP-DSG	54UPF	54UP-D
62 9/16	1590	3 1/2	1.6	63PBL	63PW	63P-DSG	63PF	63P-D	3 1/2	1.6	63UPBL	63UPW	63UP-DSG	63UPF	63UP-D
74 5/8	1895	4	1.8	74PBL	74PW	74P-DSG	74PF	74P-D	4	1.8	74UPBL	74UPW	74UP-DSG	74UPF	74UP-D
86 5/8	2200	5	2.3	86PBL	86PW	86P-DSG	86PF	86P-D	4.5	2.0	86UPBL	86UPW	86UP-DSG	86UPF	86UP-D

Standard Colors				Designer Colors*			
Black	White	Smoked Glass	Flame (F)	Black Matte (BM)	Hunter Green (HG)	Copper Hammertone (CH)	Silver Hammertone (SH)

\*For Designer Colors: BM, HG, CH, SH  
 \*To order a Designer Color, add the appropriate color suffix to the desired catalog numbers above.  
 Example: 18" x 36" (457 x 914mm) Hunter Green Shelf = 1836N-DHG  
 74" (1880mm) stationary Hunter Green Post = 74P-DHG.



Post Boot

**Post Boots** with \*Microban® Product Protection — **10.06** Patent Pending. Seals out moisture and protects the post from corrosion in areas where floors are mopped regularly. Easily slips over the bottom 5" (127mm) of

a stationary post. Built-in Microban antimicrobial. Use with standard leveling bolt or foot plates. Bags of 4. Cat. No. **9982GR-4**



Post Clamp

**Post Clamps** — **10.06** Joins units together for maximum strength. Zinc-plated. Cat. No. **9994Z**

Black. Cat. No. **9994BL**



Aluminum Split Sleeve

**Aluminum Split Sleeves** — **10.06** For high temperature, over the road, or conductive applications. Zinc or stainless steel retainer rings available to secure shelf. One bag required per shelf; 4 pairs per bag.



Foot Plate

**Foot Plates** — **10.06** Use to bolt units to the floor, or when a broader, more stable foot is desired. Zinc. Cat. No. **9993Z**

Stainless Steel. Cat. No. **9993S**

Black. Cat. No. **9993BL**



Black Split Sleeve



White Split Sleeve

**Replacement Plastic Split Sleeves** — **10.06** One bag required per shelf; 4 pairs per bag.



Glide

**Glides** — **10.06** Smooth polymer cover fits over leveling bolt to protect floors. Cat. No. **9991P**

	Cat. No.
Black Plastic Split Sleeves	<b>9985</b>
White Plastic Split Sleeves	<b>9985W</b>

**Note:** White post caps and white split sleeves are standard with white designer shelving only.



Decorative Leveling Foot

**Decorative Leveling Foot** — **10.06** Decorative alternative for post. Compensates for uneven surfaces. Chrome. Cat. No. **HDFC**

Black. Cat. No. **HDFB**



Replacement Super Adjustable Kit

**Replacement Super Adjustable Kit** Package includes 4 wedges, 4 sleeves, and 4 corner releases. Cat. No. **SAKITA2**



Basket Shelf (Posts sold separately, see page 42)

**Basket Shelf** — **10.04** 3 1/2" (89mm) deep basket with 400 lb. (182kg) weight capacity. Ideal for containing and displaying smaller items.

Size (in.)	Size (mm)	Cat. No.	
		Chrome	Black
14x36	355x914	—	<b>DD3448A</b>
14x48	355x1219	—	<b>DD3448B</b>
18x36	457x914	<b>CC9744A</b>	<b>CC9744C</b>
18x48	457x1219	<b>CC9744</b>	<b>CC9744B</b>

\*MICROBAN® and the MICROBAN® symbol are registered trademarks of the Microban Products Company, Huntersville, NC.



Super Erecta® Convenience Pak™ — 10.03

- Providing a complete shelving unit in a single box, Convenience Pak shelving is the easy-to-order alternative to separate shelving components.
- Available in Super Erecta Brite, chrome and Metroseal 3 finishes.

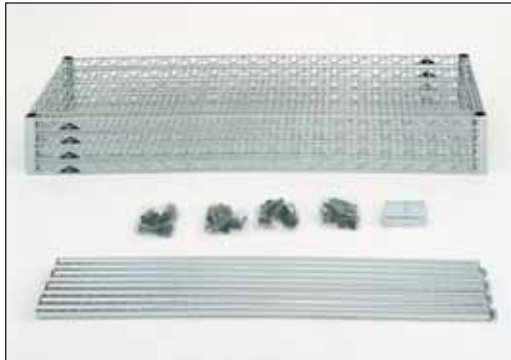

Unassembled Convenience Pak™  
Each pack includes four shelves with split sleeves and four split posts with leveling feet.



Convenience Pak unit in Chrome finish

Width/Length/Height (in./mm)		Approx. Pkd. Wt. (lbs./kg)		Cat. No. Super Erecta Brite	Cat. No. Chrome	Cat. No. Metroseal 3 with Microban®
18x36x74½	457x914x1890	51	23	EZ1836BR-4	EZ1836NC-4	EZ1836NK3-4
18x48x74½	457x1219x1890	63	28.5	EZ1848BR-4	EZ1848NC-4	EZ1848NK3-4
18x60x74½	457x1524x1890	82	37	EZ1860BR-4	EZ1860NC-4	EZ1860NK3-4
24x36x74½	610x914x1890	66	30	EZ2436BR-4	EZ2436NC-4	EZ2436NK3-4
24x48x74½	610x1219x1890	76	34.5	EZ2448BR-4	EZ2448NC-4	EZ2448NK3-4
24x60x74½	610x1524x1890	102	46	EZ2460BR-4	EZ2460NC-4	EZ2460NK3-4



Heavy-Duty Dunnage Shelves — 10.45

Enhance the weight-bearing capacity of your system.

- 36" (914mm) shelf holds 1,600 pounds (725kg) (uniformly distributed); 48" (1219mm) shelves carry up to 1,300 pounds (590kg); 60" (1524mm) shelves bear up to 1,000 pounds (453kg).
- Removable wire mat: 5/16" (7.9mm) diameter wire.
- Support frames: 1" (25mm) square tubing lifts off for easy cleaning.

Width/Length (in./mm)		Approx. Pkd. Wt. (lbs./kg)		Cat. No. Chrome	Cat. No. Metroseal 3 with Microban®	Cat. No. Stainless
18x24	457x610	14	6.3	1824DRC	1824DRK3	—
18x30	457x760	18	8.1	1830DRC	1830DRK3	—
18x36	457x914	21	9.4	1836DRC	1836DRK3	1836DRS
18x48	457x1219	28	12.6	1848DRC	1848DRK3	1848DRS
18x60	457x1524	34	15.3	1860DRC	1860DRK3	1860DRS
24x24	610x610	16	7.2	2424DRC	2424DRK3	—
24x30	610x760	20	9.0	2430DRC	2430DRK3	—
24x36	610x914	24	10.8	2436DRC	2436DRK3	2436DRS
24x48	610x1219	30	13.5	2448DRC	2448DRK3	2448DRS
24x60	610x1524	37	16.6	2460DRC	2460DRK3	2460DRS

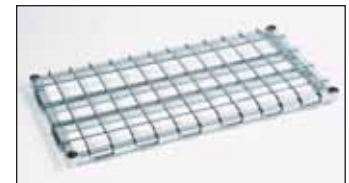

Dunnage Shelf



**Important:** In stationary shelving, stability decreases as the ratio of height to width increases and when heavier loads are placed on upper shelves. Shelving stability is attained by keeping units as wide and low as possible, and placing heavy loads low on the shelving unit.

Cantilever Shelves — 10.06

Adds convenient space above a storage unit. Drop mat design creates a retaining ledge around the entire 12" (305mm) deep shelf. Remember to order rear posts taller than front posts to accommodate these shelves.

Length (in./mm)	Approx. Pkd. Wt. Each (lbs./kg)	Cat. No. Chrome	Cat. No. Black	Cat. No. White	Cat. No. Smoked Glass
24 610	4½ 2.0	1224CSNC	1224CSNBL	1224CSNW	1224CSN-DSG
30 750	5 2.3	1230CSNC	1230CSNBL	1230CSNW	1230CSN-DSG
36 914	5¾ 2.6	1236CSNC	1236CSNBL	1236CSNW	1236CSN-DSG
42 1066	6¾ 3.1	1242CSNC	1242CSNBL	1242CSNW	1242CSN-DSG
48 1219	7¾ 3.5	1248CSNC	1248CSNBL	1248CSNW	1248CSN-DSG
60 1524	9½ 4.3	1260CSNC	1260CSNBL	1260CSNW	1260CSN-DSG



Cantilever Shelves



Indicates antimicrobial product.



Wire Stem Caster Cart

Stem Caster Carts — Wire — **11.01**

Open-wire shelf design minimizes dust and increases air circulation and visibility. Casters included. 63" (1600mm) Posts — Overall Height 67<sup>7</sup>/<sub>8</sub>" (1724mm)

Shelf Width/Length (in.) (mm)	Approx. Pkd. Wt. (lbs.) (kg)	Super Erecta Brite Finish		Chrome Finish	
		Two Swivel Two Brake Resilient Rubber Casters	Two Swivel Two Brake Polyurethane Casters	Two Swivel Two Brake Resilient Rubber Casters	Two Swivel Two Brake Polyurethane Casters
18x36 457x914	60 27	N336BBR	N336EBR	N336BC	N336EC
18x48 457x1219	72 32	N356BBR	N356EBR	N356BC	N356EC
18x60 457x1524	88 40	N366BBR	N366EBR	N366BC	N366EC
21x36 530x914	69 31	N436BBR	N436EBR	N436BC	N436EC
21x48 530x1219	81 36	N456BBR	N456EBR	N456BC	N456EC
21x60 530x1524	98 44	N466BBR	N466EBR	N466BC	N466EC
24x36 610x914	76 34	N536BBR	N536EBR	N536BC	N536EC
24x48 610x1219	92 41	N556BBR	N556EBR	N556BC	N556EC
24x60 610x1524	112 51	N566BBR	N566EBR	N566BC	N566EC



Solid Stem Caster with galvanized shelves

Stem Caster Carts — Solid — **11.10**

- Consist of four shelves, posts, plastic split sleeves, donut bumpers and 5" (127mm) poly casters (2 swivel; 2 brake).
- Strong and versatile
- Solid Shelf Stem Caster Carts feature a 1/8" (3mm) raised "ship's edge" around perimeter of shelves to help contain spillage.

With Four Galvanized Flat Shelves and Chrome-Plated Posts  
63" (1600mm) Posts — Overall Height 67<sup>7</sup>/<sub>8</sub>" (1724mm)

Shelf Width/Length (in.) (mm)	Approx. Pkd. Wt. (lbs.) (kg)	Cat. No.
24x36 610x914	100 45	F536EG
24x48 610x1219	124 56	F556EG
24x60 610x1524	152 69	F566EG



Basket Cart

Two-Shelf Basket Cart

Each 3<sup>1</sup>/<sub>2</sub>" (89mm) deep basket keeps items secure. Customize a basket cart from the following components:

- Page 42 — Mobile posts
- Page 44 — Basket shelves
- Page 48 — Casters

Super Erecta Trucks — With Super Erecta Chrome Wire Shelves — **11.25**  
63" (1600mm) Plated Posts and Aluminum Dolly

Consists of four shelves, posts, plastic split sleeves, donut bumpers and 5" (127mm), resilient rubber or poly casters as designated.

Shelf Width/Length (in.) (mm)	Approx. Pkd. Wt. (lbs.) (kg)	Catalog Number with Casters		
		Two B5DN Two B5DNB	Two B5P Two B5PB	Two 6P Set BL6P
24x36 610x914	96 43	<b>N536JC</b>	<b>N536LC</b>	<b>N536MC</b>
24x48 610x1219	118 53	<b>N556JC</b>	<b>N556LC</b>	<b>N556MC</b>
24x60 610x1524	142 64	<b>N566JC</b>	<b>N566LC</b>	<b>N566MC</b>

Overall heights: JC, LC models — 68<sup>7</sup>/<sub>16</sub>" (1739mm), MC models — 70<sup>1</sup>/<sub>16</sub>" (1800mm).

- JC models: Standard swivel plate casters, two with brake; resilient rubber tread.
- LC models: Standard swivel plate casters, two with brake; polyurethane tread.
- MC models: Larger plate casters; two swivel; one swivel/brake set; polyurethane tread.

**Metro Tip:**

In applications where thresholds are frequently encountered, Metro Super Erecta Trucks provide durability and increased stability.



Super Erecta Wire Truck

Slanted Shelf Trucks and Carts — **31.05**

Shelves slope backwards 2" (51mm) to keep items from falling during transport. Standard-duty carts have four poly stem casters. Heavy-duty trucks are dolly mounted.

Width/Length (in.) (mm)	Height (in.) (mm)	No. Shelves	Castors	Description	Approx. Pkd. Wt. (lbs.) (kg)	Cat. No.
24x36 610x914	62 <sup>1</sup> / <sub>16</sub> 1577	3	2-BL6P, 2-6P	Heavy-Duty	140 63	<b>AST35MC</b>
24x48 610x1219	62 <sup>1</sup> / <sub>16</sub> 1577	3	2-BL6P, 2-6P	Heavy-Duty	162 72.4	<b>AST55MC</b>
24x60 610x1524	62 <sup>1</sup> / <sub>16</sub> 1577	3	2-BL6P, 2-6P	Heavy-Duty	187 84.1	<b>AST65MC</b>
24x36 610x914	59 <sup>7</sup> / <sub>8</sub> 1521	3	4-Poly Casters	Standard-Duty	105 47.2	<b>AST35DC</b>
24x48 610x1219	59 <sup>7</sup> / <sub>8</sub> 1521	3	4-Poly Casters	Standard-Duty	125 56.2	<b>AST55DC</b>
24x60 610x1524	59 <sup>7</sup> / <sub>8</sub> 1521	3	4-Poly Casters	Standard-Duty	150 67.5	<b>AST65DC</b>

Additional Slanted Shelves

Width/Length (in.) (mm)	Approx. Pkd. Wt. (lbs.) (kg)	Cat. No. Chrome
24x36 610x914	13 6	<b>SLT2436NC</b>
24x48 610x1219	17 8	<b>SLT2448NC</b>
24x60 610x1524	22 10	<b>SLT2460NC</b>

Handles — **11.40**

Use on corresponding width Super Erecta units to provide additional maneuverability to dolly carts or stem caster carts. Split sleeves included for attaching to cart.

Length (in.) (mm)	Push Handles		Extended Handles	
	Cat. No. Chrome	Cat. No. Stainless	Cat. No. Chrome	Cat. No. Stainless
14 355	<b>PH14NC</b>	<b>PH14NS</b>	<b>EH14NC</b>	<b>EH14NS</b>
18 457	<b>PH18NC</b>	<b>PH18NS</b>	<b>EH18NC</b>	<b>EH18NS</b>
21 530	<b>PH21NC</b>	<b>PH21NS</b>	<b>EH21NC</b>	<b>EH21NS</b>
24 610	<b>PH24NC</b>	<b>PH24NS</b>	<b>EH24NC</b>	<b>EH24NS</b>
30 760	<b>PH30NC</b>		<b>EH30NC</b>	
36 914	<b>PH36NC</b>		<b>EH36NC</b>	

Note: Handles fit unit widths only. Extended handles add 6" (152.4mm) to length of unit.



Push Handle



Extended Handle



Standard-Duty Slanted Shelf Cart



5M



5MB

Rigid stem casters are often ordered two per unit for improved tracking and handling. Rigid caster channels are provided with each two rigid stem casters at no charge.

Stem Casters — 11.20

Use with Super Erecta posts and shelves (see pages 37 and 42) to create a mobile shelving unit to meet your special needs. Stem casters are shipped with donut bumper at no additional charge.

Wheel Diameter (in.) (mm)	Face (in.) (mm)	Load Rating (lbs.) (kg)	Type	Wheel Tread	Approx. Pkd. Wt. (lbs.) (kg)	Cat. No.
4 102	1/2 12	125 56	Stem/Swivel	Resilient	1 1/2 .6	4LD
5 127	1/2 12	125 56	Stem/Swivel	Resilient	2 .9	5LD
5 127	1/4 32	200 90	Stem/Swivel	Resilient	2 1/2 1.1	5M
5 127	1/4 32	200 90	Stem/Brake	Resilient	2 3/8 1.2	5MB
5 127	1/4 32	200 90	Stem/Rigid	Resilient	3 1/2 1.5	5MR
5 127	1/4 32	250 111	Stem/Swivel	High Modulus Donut	2 1/2 1.1	5MDA
5 127	1/4 32	250 111	Stem/Brake	High Modulus Donut	2 3/8 1.17	5MDBA
5 127	1/4 32	250 111	Stem/Rigid	High Modulus Donut	2 3/8 1.08	5MDRA
5 127	1/4 32	300 135	Stem/Swivel	Polyurethane	2 1/8 .94	5MP
5 127	1/4 32	300 135	Stem/Brake	Polyurethane	2 1/4 1	5MPB
5 127	1/4 32	300 135	Stem/Rigid	Polyurethane	2 .9	5MPR
6 152	1/4 32	300 135	Stem/Swivel	Polyurethane	2 1/4 1.08	6MP
6 152	1/4 32	300 135	Stem/Brake	Polyurethane	2 1/2 .94	6MPB
6 152	1/4 32	300 135	Stem/Rigid	Polyurethane	2 1/4 1	6MPR

- Note 1: Rigid casters are held in position by a connecting channel. When ordering rigid casters, shelf width must be known.
- Note 2: Load Height for all 5M and 5MP casters — 6 3/32" ± 1/16" (155 ± 1.5mm).
- Note 3: Load Height for 4LD caster — 4 5/8" ± 1/16" (118 ± 1.5mm).
- Note 4: Load Height for 5LD caster — 5 5/8" ± 1/16" (143 ± 1.5mm).
- Note 5: Brakes are foot-operated.

Polymer Casters — 11.20

Innovative polymer stem casters offer corrosion resistance and enhanced durability. Appropriate for all medium-duty mobile applications. Donut bumpers included.

- All-polymer horn, stainless steel axle and hardware.
- 5" (127mm) diameter polyurethane wheel, sleeve-style axle bearing and an optional toe-operated brake mechanism.



5PC



5PCB

Wheel Tread	Type	Face (in.) (mm)	Load Rating (lbs.) (kg)	Approx. Pkd. Wt. (lbs.) (kg)	Temp Range (continuous)	Cat. No.	Cat. No. Antimicrobial
Polyurethane	Swivel	1 1/4 32	300 135	2 .9	-20°F to 120°F	5PC	5PCM
Polyurethane	Brake	1 1/4 32	300 135	2 .9	-20°F to 120°F	5PCB	5PCBM
Polyurethane	Rigid	1 1/4 32	300 135	2 .9	-20°F to 120°F	5PCR	

Note 1: Rigid casters are held in place by a connecting channel. When ordering, shelf depth must be provided.

Stainless Steel Cart-Washable Stem Casters — 11.20

Stem casters are shipped with donut bumpers at no extra charge.



5MDGSA

Wheel Diameter (in.) (mm)	Face (in.) (mm)	Load Rating (lbs.) (kg)	Type	Wheel Tread	Approx. Pkd. Wt. (lbs.) (kg)	Cat. No.
5 127	1/4 32	250 111	Swivel	High Modulus	2 1/2 1.1	5MDGSA
5 127	1/4 32	250 111	Brake	High Modulus Donut	2 3/8 1.17	5MDBGSA
5 127	1/4 32	250 111	Rigid	High Modulus Donut	2 3/8 1.08	5MDRGSA
5 127	1/4 32	300 135	Swivel	Polyurethane	2 1/8 .94	5MPGSA
5 127	1/4 32	300 135	Brake	Polyurethane	2 1/4 1	5MPBGSA
5 127	1/4 32	300 135	Rigid	Polyurethane	2 .9	5MPRGSA

- Note 1: Rigid casters are held in position by a connecting channel. When ordering rigid casters, shelf width must be known.
- Note 2: Load Height for all 5MD and 5MP casters — 6 3/32" ± 1/16" (155 ± 1.5mm).
- Note 3: All casters are grease sealed with zerk fittings in swivel and axle.
- Note 4: Brakes are foot-operated.

Indicates antimicrobial product.

High-temperature Autoclave Stem Casters



5MHTPB



5MHTNB

Type	Wheel Tread	Load Rating (lbs.) (kg)	Approx. Pkd. Wt. (lbs.) (kg)	Cat. No.
Swivel	Hi-temp Phenolic	300 135	2 1/5 1.0	5MHTP
Brake	Hi-temp Phenolic	300 135	2 4/5 1.3	5MHTPB
Swivel	Hi-temp Nylon	300 135	2 2/5 1.1	5MHTN
Brake	Hi-temp Nylon	300 135	3 1.4	5MHTNB

Note: Casters are temperature rated for up to 300°F (149°C).

See page 42 for posts for Stem Casters.

Swedged Posts — For cart washable and autoclave applications

Each Type 304 stainless post has an aluminum cap swedged into the top of the post. For use with standard stem casters.



Swedged Post

Description	Dimensions (in.) (mm)	Cat. No.
Stem Caster Post	33 875	33UPS-SW
Stem Caster Post	54 1370	54UPS-SW
Stem Caster Post	63 1600	63UPS-SW



## Donut Bumpers — 11.40

Diameter (in.) (mm)		Height (lbs.) (kg)		Cat. No.
3 1/2	89	3/4	19	9992DB*
5 1/2	140	1 3/16	21	9992N

\*Included with each Super Erecta stem caster as noted on previous page.



Donut Bumper

## Decorative Casters — 10.06

- Black nylon housing with non-marking polymer tread.
- 2 1/2" (63mm) models have threaded stem and attach to stationary shelving posts.
- 4" (100mm) casters include threaded insert for use with mobile posts.



HDC5B      HDC5BB

Type	Diameter (in.) (mm)		Fits Post Type	Cat. No.
Swivel/Brake	2 1/2	63	Stationary	HDC3BB
Swivel	4	100	Mobile	HDC5B
Swivel/Brake	4	100	Mobile	HDC5BB

Castors shipped with post inserts (as shown left) for adaptability to mobile posts.

The following information is to assist you in the selection of the appropriate caster for your specific application. Remember, the selection of the proper caster is determined by the load requirements, the operating environment, and other special conditions.

Wheel Material	Resistance to Oil & Grease	Rollability	Floor Protection	Noise
Resilient Rubber	Low	Fair	Good	Low
Neoprene	High	Good	Good	Low
Polyurethane	High	Good	Good	Moderate
High Modulus Rubber	High	Good	Good	Low
Conductive	Low	Fair	Good	Low

### Caster Tips:

1. The total weight of the equipment and its load should not exceed three times the load rating per caster.
2. Given the same wheel material, the larger the wheel diameter, the greater the load capacity and the better the rollability.
3. Caster mounting patterns affect maneuverability and steering of the equipment.
4. Plate casters generally have wheels of larger diameter and can usually carry more weight and take more abuse than stem casters.
5. Ball bearings and roller bearings in the wheel generally perform better and carry more weight than engineered plastic bearings or sintered metal bearings. Metro stem casters in the 5MP and the 5MDA series have ball bearings in the swivel and the wheel. Most plate casters have ball bearings in the swivel and ball or roller bearings in the wheel.
6. Wheel tread shapes are generally flat, rounded or tapered. Tapered wheels, like donut-shaped wheels, tend to roll more easily. High-modulus donut wheels offer resiliency and mobility, reduce noise, and absorb shock on uneven or rough floors.

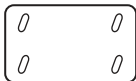

For maneuverability, use 4 swivel casters.

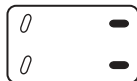

For steering control use 2 swivel and 2 rigid casters.

Additional stem and plate casters, in various sizes, are available.

Made-To-Order Truck Dollies (Aluminum)\* — 11.37

Select the desired dolly size from chart below and combine with desired plate casters found on page 23 to make your corresponding size Super Erecta unit mobile. For example: D1824NCB, four #B5DN = one 18"x24" (457x610mm) aluminum dolly frame with four 5" (127mm) plate swivel casters.



Dolly Frame

**Metro Fact:**

Metro dolly frames and stock truck dollies add 3 1/8" (78mm) to the length of the unit and 3 3/8" (87mm) to the unit width.

Stainless steel frames and staked posts are recommended for heavy-duty applications.

Truck Dolly Frames

Shelf Width/Length (in.)	Shelf Width/Length (mm)	ALUMINUM		STAINLESS	
		Cat. No. with Corner Bumper	Cat. No. with Wraparound Bumper	Cat. No. with Corner Bumper	Cat. No. with Wraparound Bumper
18x24	457x610	D1824NCB	D1824NP	D1824SCB	D1824SP
18x30	457x760	D1830NCB	D1830NP	D1830SCB	D1830SP
18x36	457x914	D1836NCB	D1836NP	D1836SCB	D1836SP
18x42	457x1066	D1842NCB	D1842NP	D1842SCB	D1842SP
18x48	457x1219	D1848NCB	D1848NP	D1848SCB	D1848SP
18x60	457x1524	D1860NCB	D1860NP	D1860SCB	D1860SP
18x72	457x1825	D1872NCB	D1872NP	D1872SCB	D1872SP
21x24	530x610	D2124NCB	D2124NP	D2124SCB	D2124SP
21x30	530x760	D2130NCB	D2130NP	D2130SCB	D2130SP
21x36	530x914	D2136NCB	D2136NP	D2136SCB	D2136SP
21x42	530x1066	D2142NCB	D2142NP	D2142SCB	D2142SP
21x48	530x1219	D2148NCB	D2148NP	D2148SCB	D2148SP
21x60	530x1524	D2160NCB	D2160NP	D2160SCB	D2160SP
21x72	530x1825	D2172NCB	D2172NP	D2172SCB	D2172SP
24x24	610x610	D2424NCB	D2424NP	D2424SCB	D2424SP
24x30	610x760	D2430NCB	D2430NP	D2430SCB	D2430SP
24x36	610x914	D2436NCB	D2436NP	D2436SCB	D2436SP
24x42	610x1066	D2442NCB	D2442NP	D2442SCB	D2442SP
24x48	610x1219	D2448NCB	D2448NP	D2448SCB	D2448SP
24x60	610x1524	D2460NCB	D2460NP	D2460SCB	D2460SP
24x72	610x1825	D2472NCB	D2472NP	D2472SCB	D2472SP

Note 1: Replacement wraparound bumper kits are available. See your Metro representative for details.  
 Note 2: "Made To Order Dollies" are non-returnable.  
 Note 3: Maximum load capacity for dollies is 1,000 lbs. (454kg), depending on caster selection.

Stock Truck Dollies — 11.36

These are aluminum dollies with a single catalog number for frame and casters with wraparound bumper. Use with Super Erecta Shelving and posts to create mobile carts for higher weight capacities. See specific plate caster load ratings (page 51) to determine appropriate stock truck dolly.

Shelf Width/Length (in.)	Shelf Width/Length (mm)	Casters	Cat. No.	Shelf Width/Length (in.)	Shelf Width/Length (mm)	Casters	Cat. No.
24x36	610x914	Two B5DN/Two B5DNB	D53JN	24x48	610x1219	Two 8P/Two BL8P	D55PN
24x48	610x1219	Two B5DN/Two B5DNB	D55JN	24x60	610x1524	Two 8P/Two BL8P	D56PN
24x60	610x1524	Two B5DN/Two B5DNB	D56JN	24x48	610x1219	Two C8DA/Two C8DSL*	D55PSLN
24x36	610x914	Two 6P/Two BL6P	D53MN	24x60	610x1524	Two C8DA/Two C8DSL*	D56PSLN
24x48	610x1219	Two 6P/Two BL6P	D55MN				
24x60	610x1524	Two 6P/Two BL6P	D56MN				

\*Swivel Lock.  
 Note: Replacement wraparound bumper kits are available. See your Metro representative for details.



Stock Dolly



Staked Post

Staked Posts — For use with Truck Dollies

Each post connects to a truck dolly through the stem receptacle. The stem receptacles are staked into the bottom of these posts to ensure a durable connection in abusive applications.

Height* (in.)	Height* (mm)	Approx. Pkd. Wt. (lbs.)	Approx. Pkd. Wt. (kg)	Cat. No. Chrome	Cat. No. Stainless
54 9/16	1385	3	1.4	54P-STKD	54PS-STKD
62 9/16	1590	3 1/2	1.6	63P-STKD	63PS-STKD
74 5/8	1895	4	1.8	74P-STKD	74PS-STKD

\*Height includes leveling bolt and cap.

Pitched Aluminum Dust Cover — 11.37

For "Made-To-Order" dollies, these covers act as a barrier between the floor and the bottom shelf of cart for cleanliness. These covers are factory-assembled and must be ordered with desired dolly frame.

Width/Length (in.)	Width/Length (mm)	Approx. Pkd. Wt. (lbs.)	Approx. Pkd. Wt. (kg)	Cat. No.
24x36	610x914	7	3.2	DCT2436N
24x42	610x1066	7	3.2	DCT2442N
24x48	610x1219	8	3.6	DCT2448N
24x60	610x1524	8	3.6	DCT2460N
24x72	610x1825	8	3.6	DCT2472N



Pitched Aluminum Dust Cover

Plate Casters — 11.37

Use in conjunction with Metro “Made-To-Order” truck dollies to assemble a mobile base appropriate for your needs.

Diameter (in.)	Wheel Face (in.)	Load Rating (lbs.)	Load Rating (kg)	Load Weight Each (lbs.)	Load Weight Each (kg)	Type	Wheel Tread	Cat. No.	
5	125	13/8	35	225	101	2 1/8 .99	Swivel	Donut Neoprene	B5DN
5	125	13/8	35	225	101	2 1/4 1	Brake	Donut Neoprene	B5DNB
5	125	13/8	35	225	101	2 .9	Rigid	Donut Neoprene	B5DNR
5	125	1 1/4	31	300	135	2 1/8 .99	Swivel	Polyurethane	B5P
5	125	1 1/4	31	300	135	2 1/4 1	Brake	Polyurethane	B5PB
5	125	1 1/4	31	300	135	2 .9	Rigid	Polyurethane	B5PR
5	125	2	51	500	225	8 3.6	Swivel	Polyurethane	C5P
5	125	2	51	500	225	8 1/4 3.7	Brake	Polyurethane	C5PB
5	125	2	51	500	225	8 3.63	Rigid	Polyurethane	C5PR
6	152	2	51	400	181	8 3.63	Swivel	Hi-Modulus Donut	C6DA
6	152	2	51	400	181	8 3.63	Swivel/Brake	Hi-Modulus Donut	C6DBA
6	152	2	51	400	181	8 3.63	Rigid	Hi-Modulus Donut	C6DRA
6	152	2	51	400	181	8 3.63	Swivel/Lock	Hi-Modulus Donut	C6DSL A
8	203	2	51	450	204	9 4.08	Swivel	Hi-Modulus Donut	C8DA
8	203	2	51	450	204	9 4.08	Swivel/Brake	Hi-Modulus Donut	C8DBA
8	203	2	51	450	204	9 4.08	Rigid	Hi-Modulus Donut	C8DRA
8	203	2	51	450	204	9 4.08	Swivel/Lock	Hi-Modulus Donut	C8DSL A
6	150	2	51	500	225	4 3/4 2.1	Swivel	Polyurethane	C6P
6	150	2	51	500	225	4 7/8 2.2	Brake	Polyurethane	C6PB
6	150	2	51	500	225	3 1/2 1.6	Rigid	Polyurethane	C6PR
6	150	2	51	500	225	5 2.3	Swivel/Lock	Polyurethane	C6PS/L-LH
8	200	2	51	700	315	5 3/4 2.6	Swivel	Polyurethane	C8P
8	200	2	51	700	315	5 7/8 2.65	Brake	Polyurethane	C8PB
8	200	2	51	700	315	4 1/2 2	Rigid	Polyurethane	C8PR
8	200	2	51	700	315	6 2.7	Swivel/Lock	Polyurethane	C8PS/L-LH



B5DNB with Wheel Brake



B5P Polyurethane

Note 1: Brakes are foot-operated.

Note 2: 8" (200mm) casters should not be used on units less than 21" (530mm) wide.

Note 3: Swivel lock casters are set diagonally on the left-hand sides when dolly mounted.

Load Heights: B5 Series — 6 1/4" (159mm) C5 Series — 6 1/2" (165mm) 6P Series — 7 7/8" (200mm)  
 (±1/16") (±1.6mm) C6 Series — 7 1/2" (190mm) 8P Series — 9 13/16" (249mm)  
 C8 Series — 9 1/2" (241mm)

Stainless Steel Cart-Washable Plate Casters — 11.37

Wheel Diameter (in.)	Face (in.)	Load Rating (lbs.)	Load Rating (kg)	Weight Each (lbs.)	Weight Each (kg)	Type	Wheel Tread	Cat. No.	
5	125	1 1/4	31	300	135	2 1/8 .99	Swivel	Polyurethane	B5PGSA
5	125	1 1/4	31	300	135	2 1/4 1	Brake	Polyurethane	B5PBGSA
5	125	1 1/4	31	300	135	2 .9	Rigid	Polyurethane	B5PRGSA
6	150	1 1/2	38	600	270	4 3/4 2.1	Swivel	Polyurethane	C6PGSA
6	150	1 1/2	38	600	270	4 7/8 2.2	Brake	Polyurethane	C6PBGSA
6	150	1 1/2	38	600	270	3 1/2 1.6	Rigid	Polyurethane	C6PRGSA
8	200	1 1/2	38	800	360	5 3/4 2.6	Swivel	Polyurethane	C8PGSA
8	200	1 1/2	38	800	360	5 7/8 2.65	Brake	Polyurethane	C8PBGSA
8	200	1 1/2	38	800	360	4 1/2 2	Rigid	Polyurethane	C8PRGSA

See above notes for important specification information.



B5PGSA

Dolly Adaptor Kits

When ordering a new dolly frame for use with MetroMax iQ, include Mounting Bolt Kit

DMK-2X

(one per dolly frame) on order.

See page 49 for additional specifications and appropriate parameters for all types of Metro casters.

General Guidelines for Metro Carts Used in Over-the-Road Applications

For applications where carts are loaded on to or off of trucks for transportation, and/or where thresholds exceeding 3/8" in height are repeatedly encountered:

- A dolly is recommended for maximum useful life.

- Casters of at least 6" diameter are recommended. Consideration should be given to the shock absorbing ability of the caster wheel, but selection will need to be based upon the specifics of the application.
- Aluminum split sleeves and staked posts should be used.

- Weight load should be limited to approximately 750 lbs. depending on the specifics of the application.

Consult your Metro representative with the details of the Over-the-Road application. Each application is unique, and the preceding points are intended only as general guidelines.

### Brake Lock/Swivel Lock Combination Casters — 11.70

Patented, foot-operated design enables a single pair of casters to serve as swivel, rigid or brake casters. Conveniently positioned on the dolly, not on the wheels, the downward pressure pedals prevent scuffing of shoes.



Brake Lock/Swivel Lock combination casters

- **How It Works**  
Brake lock/swivel lock caster sets are operated by two separate foot pedals. One pedal locks the two wheels in a rigid position or releases them to swivel; the other pedal engages and releases brakes on the same two wheels.
- **Convenient**  
Pedals are on the dolly, not the wheels, making operation more convenient. Downward pressure on the pedals save shoes from scuffing.
- **Casters**  
Long wearing polyurethane. Resists abrasion. Non-marking, shock absorbing. Wheels are available in 6" (152mm) and 8" (203mm) size.
- **Recommended Caster Selection**  
Two swivel casters at one end and brake/swivel lock set at the other end. Other caster combinations can be used, however, including brake/swivel lock sets at both ends. Wraparound bumper recommended.

Type	Wheel Diameter (in.) (mm)		Face (in.) (mm)		For Use With	Load Rating (lbs.) (kg)		Weight (lbs.) (kg)		Cat. No.
*Brake/Lock	6	152	2	51	24" (610mm) Deep Dolly and 6P Caster	600	272	7 <sup>1</sup> / <sub>4</sub>	3.3	BL6P24
*Brake/Lock	8	203	2	51	24" (610mm) Deep Dolly and 8P Caster	600	272	9	4.1	BL8P24
Swivel	6	152	2	51	BL6P24 Brake/Lock Set	600	272	5 <sup>1</sup> / <sub>4</sub>	2.3	6P
Rigid	6	152	2	51	6P Swivel Caster	600	272	5	2.26	6PR
Swivel	8	203	2	51	BL8P24 Brake/Lock Set	600	272	6 <sup>1</sup> / <sub>2</sub>	2.9	8P
Rigid	8	203	2	51	8P Swivel Caster	600	272	6	2.7	8PR

\*Above part numbers include the brake/lock mechanism with two casters. Order dolly separately (see page 28). In addition order either two 6P or two 8P casters.  
Example: (1) D2436NP and (1) BL6P24 or (1) BL8P24 and two 6P or two 8P.

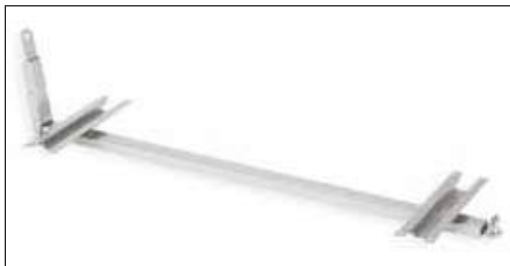

Tow Bar Assembly

### Tow Bar Assembly — 11.70

Attaches to underside of dolly to facilitate transport of dolly carts in tandem. Must be factory assembled and ordered with desired dolly frame (see page 50).

Length (in.) (mm)	Cat. No.
48 1219	TBA48

**Note:** "C" plate caster must be used with Tow Bar Assembly. Tow Bar Assembly for use with 24" (610mm) units only.

**Note:** Number of carts to be towed, weight on carts, and towing route affect operation of tow bar assembly. **Before ordering, contact your Metro representative.**

Tow Bar Assembly not appropriate for use with Brake Lock/Swivel Lock system.



Push Handle

### Handles — 11.40

Use on corresponding width Super Erecta units to provide additional maneuverability to dolly carts or stem caster carts. Split sleeves included for attaching to cart.

Length (in.) (mm)	Cat. No. Chrome	Push Handles		Extended Handles	
		Cat. No. Stainless	Cat. No. Chrome	Cat. No. Stainless	Cat. No. Stainless
14 355	PH14NC	PH14NS	EH14NC		EH14NS
18 457	PH18NC	PH18NS	EH18NC		EH18NS
21 530	PH21NC	PH21NS	EH21NC		EH21NS
24 610	PH24NC	PH24NS	EH24NC		EH24NS
30 760	PH30NC			EH30NC	
36 914	PH36NC			EH36NC	

**Note:** Handles fit unit widths only. Extended handles add 6" (152.4mm) to length of unit.



Extended Handle

Shelf Dividers for Super Erecta Shelves — 10.04

Keep shelf contents orderly with these 8" (203mm) high, pressure-fit dividers.

Shelf Width (in.)	Shelf Width (mm)	Approx. Pkd. Wt. (lbs.)	Approx. Pkd. Wt. (kg)	Cat. No. Plated	Cat. No. Black	Cat. No. White	Cat. No. Smoked Glass	Cat. No. Metroseal 3 with Microban®	Cat. No. Stainless	Cat. No. Designer Colors
14	355	1.8	0.8	DD14C	DD14BL	DD14W	DD14-DSG	DD14K3	DD14S	DD14-D
18	457	2.25	1.0	DD18C	DD18BL	DD18W	DD18-DSG	DD18K3	DD18S	DD18-D
21	530	2.5	1.1	DD21C	DD21BL	DD21W	DD21-DSG	DD21K3	DD21S	DD21-D
24	610	2.75	1.3	DD24C	DD24BL	DD24W	DD24-DSG	DD24K3	DD24S	DD24-D
30	760	3.25	1.5	DD30C	DD30BL	DD30W	DD30-DSG		DD30S	
36	914	3.75	1.7	DD36C	DD36BL	DD36W	DD36-DSG		DD36S	

Universal 8" (203mm) Shelf Dividers — Light Duty — 9.25

Each divider includes a panel and two clips to connect to any Super Erecta or Super Adjustable wire self. Corrosion proof.

Nominal Length (in.)	Nominal Length (mm)	Fits Shelf Depth	Approx. Pkd. Wt. (lbs.)	Approx. Pkd. Wt. (kg)	Cat. No.
18	457	18", 21" (457, 530mm)	1.3	0.6	MUD18-8
24	610	24" (610mm)	1.6	0.7	MUD24-8



Shelf Divider for Super Erecta Shelves

Shelf-to-Shelf Dividers — 9.25

Full height dividers efficiently compartmentalize the space between two shelves. Corrosion proof. Compatible with Super Erecta and Super Adjustable wire shelves.

Fits Shelf Depth (in.)	Fits Shelf Depth (mm)	Nominal Depth (in.)	Nominal Depth (mm)	Approx. Pkd. Wt. (lbs.)	Approx. Pkd. Wt. (kg)	Cat. No.
18, 21	457, 530	16	406	2.3	1.0	MD18-16
18, 21	457, 530	20	508	2.5	1.1	MD18-20
18, 21	457, 530	24	610	3.8	1.7	MD18-24
24	610	16	406	2.8	1.2	MD24-16
24	610	20	508	3.0	1.3	MD24-20
24	610	24	610	4.4	2.0	MD24-24

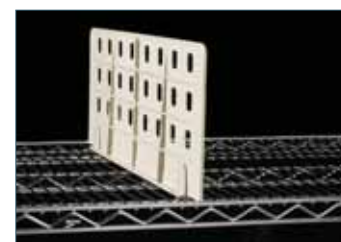

Universal Shelf Divider

Shelf Ledges — Side and Back — 10.04

For stationary or mobile installations, ledges prevent items from protruding or falling from shelves.

1" (25mm) High Ledges

Length (in.)	Length (mm)	Approx. Pkd. Wt. (lbs.)	Approx. Pkd. Wt. (kg)	Cat. No. Plated	Cat. No. Black	Cat. No. White	Cat. No. Smoked Glass	Cat. No. Stainless	Cat. No. Designer Colors
14	355	0.58	0.25	L14N-1C	L14N-1BL	L14N-1W	L14N-1-DSG	L14N-1S	L14N-1-D
18	457	0.75	0.33	L18N-1C	L18N-1BL	L18N-1W	L18N-1-DSG	L18N-1S	L18N-1-D
21	530	0.75	0.33	L21N-1C	L21N-1BL	L21N-1W	L21N-1-DSG	L21N-1S	L21N-1-D
24	610	1.0	0.45	L24N-1C	L24N-1BL	L24N-1W	L24N-1-DSG	L24N-1S	L24N-1-D
30	760	2.0	0.9	L30N-1C	L30N-1BL	L30N-1W	L30N-1-DSG	L30N-1S	L30N-1-D
36	914	2.5	1.13	L36N-1C	L36N-1BL	L36N-1W	L36N-1-DSG	L36N-1S	L36N-1-D
42	1066	2.75	1.25	L42N-1C	L42N-1BL	L42N-1W	L42N-1-DSG	L42N-1S	L42N-1-D
48	1219	3.5	1.58	L48N-1C	L48N-1BL	L48N-1W	L48N-1-DSG	L48N-1S	L48N-1-D
54	1370	4.4	1.65	L54N-1C	L54N-1BL	L54N-1W	L54N-1-DSG	L54N-1S	L54N-1-D
60	1524	3.75	1.68	L60N-1C	L60N-1BL	L60N-1W	L60N-1-DSG	L60N-1S	L60N-1-D
72	1828	4.0	1.81	L72N-1C	L72N-1BL	L72N-1W	L72N-1-DSG	L72N-1S	L72N-1-D



1" (25mm) Ledge



4" (102mm) Ledge

4" (100mm) High Stackable Ledges

Shelf Width (in.)	Shelf Width (mm)	Approx. Pkd. Wt. (lbs.)	Approx. Pkd. Wt. (kg)	Cat. No. Plated	Cat. No. Black	Cat. No. White	Cat. No. Smoked Glass	Cat. No. Metroseal 3 with Microban®	Cat. No. Stainless	Cat. No. Designer Colors
14	355	0.83	0.36	L14N-4C	L14N-4BL	L14N-4W	L14N-4-DSG	L14N-4K3	L14N-4S	L14N-4-D
18	457	1.5	0.68	L18N-4C	L18N-4BL	L18N-4W	L18N-4-DSG	L18N-4K3	L18N-4S	L18N-4-D
21	530	1.75	0.71	L21N-4C	L21N-4BL	L21N-4W	L21N-4-DSG	L21N-4K3	L21N-4S	L21N-4-D
24	610	2.0	0.9	L24N-4C	L24N-4BL	L24N-4W	L24N-4-DSG	L24N-4K3	L24N-4S	L24N-4-D
30	760	2.25	1.03	L30N-4C	L30N-4BL	L30N-4W	L30N-4-DSG	L30N-4K3	L30N-4S	L30N-4-D
36	914	2.75	1.25	L36N-4C	L36N-4BL	L36N-4W	L36N-4-DSG	L36N-4K3	L36N-4S	L36N-4-D
42	1066	3.25	1.48	L42N-4C	L42N-4BL	L42N-4W	L42N-4-DSG	L42N-4K3	L42N-4S	L42N-4-D
48	1219	3.75	1.68	L48N-4C	L48N-4BL	L48N-4W	L48N-4-DSG	L48N-4K3	L48N-4S	L48N-4-D
54	1370	3.8	1.73	L54N-4C	L54N-4BL	L54N-4W	L54N-4-DSG	L54N-4K3	L54N-4S	L54N-4-D
60	1524	4.0	1.81	L60N-4C	L60N-4BL	L60N-4W	L60N-4-DSG	L60N-4K3	L60N-4S	L60N-4-D
72	1828	5.0	2.25	L72N-4C	L72N-4BL	L72N-4W	L72N-4-DSG	L72N-4K3	L72N-4S	L72N-4-D

Note: Actual ledge length is approximately 1" (25mm) shorter than nominal shelf length/width.



Indicates antimicrobial product.

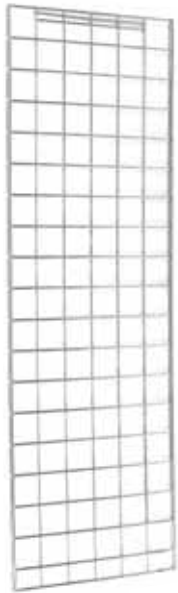

Enclosure Panel

Enclosure Panels — **10.04** **10.30**

An efficient way to enclose space for stationary or mobile applications.

- Can be used with Super Erecta® and Super Adjustable wire shelving, and Super Erecta solid shelving.
- Appropriate mounting hardware supplied with each panel.

Width/Height		For Nominal Post Height		Grid Opening		Weight		Cat. No. Chrome	Cat. No. Stainless
(in.)	(mm)	(in.)	(mm)	(in.)	(mm)	(lbs.)	(kg)		
12 <sup>3</sup> / <sub>8</sub> x50 <sup>3</sup> / <sub>4</sub>	313x1289	54	1370	2 <sup>7</sup> / <sub>8</sub> x3 <sup>5</sup> / <sub>8</sub>	73x92	3	1.4	EP35C	EP35S
12 <sup>3</sup> / <sub>8</sub> x59 <sup>3</sup> / <sub>4</sub>	313x1518	63	1600	2 <sup>7</sup> / <sub>8</sub> x3 <sup>5</sup> / <sub>8</sub>	73x92	4	1.8	EP36C	EP36S
12 <sup>3</sup> / <sub>8</sub> x70 <sup>1</sup> / <sub>2</sub>	313x1791	74	1880	2 <sup>7</sup> / <sub>8</sub> x3 <sup>5</sup> / <sub>8</sub>	73x92	6	2.7	EP37C	
18 <sup>3</sup> / <sub>8</sub> x50 <sup>3</sup> / <sub>4</sub>	464x1289	54	1370	3 <sup>3</sup> / <sub>8</sub> x3 <sup>5</sup> / <sub>8</sub>	86x92	5	2.3	EP55C	EP55S
18 <sup>3</sup> / <sub>8</sub> x59 <sup>3</sup> / <sub>4</sub>	464x1518	63	1600	3 <sup>3</sup> / <sub>8</sub> x3 <sup>5</sup> / <sub>8</sub>	86x92	6	2.7	EP56C	EP56S
18 <sup>3</sup> / <sub>8</sub> x70 <sup>1</sup> / <sub>2</sub>	464x1791	74	1800	3 <sup>3</sup> / <sub>8</sub> x3 <sup>5</sup> / <sub>8</sub>	86x92	7	3.2	EP57C	

All panels are 7/8" (22mm) deep.

**Note: Units with a solid shelf in the top position require the use of a three-sided double snake frame (see page 55) directly below it.**

Ordering Guide for Enclosure Panels

Super Erecta and Super Adjustable Wire Shelving Units Super Erecta Solid Shelving Units

Ends — Panels required for each end according to shelf width, as follows:

Nominal Post Height (in.) (mm)	18" (457mm) Nominal Shelf Width	21" (530mm) Nominal Shelf Width	24" (610mm) Nominal Shelf Width	30" (760mm) Nominal Shelf Width	36" (914mm) Nominal Shelf Width
54 1370	(1) EP35	(1) EP35	(1) EP55	(2) EP35	(1) EP35 (1) EP55
63 1600	(1) EP36	(1) EP36	(1) EP56	(2) EP36	(1) EP36 (1) EP56
74 1880	(1) EP37	(1) EP37	(1) EP57	(2) EP37	(1) EP37 (1) EP57

Backs — Requires multiple panels in quantities shown for specific length shelf:

For Wire Shelves:

Nominal Post Height (in.) (mm)	30" (760mm) Nominal Shelf Length	36" (914mm) Nominal Shelf Length	42" (1066mm) Nominal Shelf Length	48" (1219mm) Nominal Shelf Length	54" (1370mm) Nominal Shelf Length	60" (1524mm) Nominal Shelf Length	72" (1825mm) Nominal Shelf Length
54 1370	(2) EP35	(1) EP35 (1) EP55	(2) EP55	(2) EP35 (1) EP55	(1) EP35 (2) EP55	(3) EP55	(1) EP35 (3) EP55
63 1600	(2) EP36	(1) EP36 (1) EP56	(2) EP56	(2) EP36 (1) EP56	(1) EP36 (2) EP56	(3) EP56	(1) EP36 (3) EP56
74 1880	(2) EP37	(1) EP37 (1) EP57	(2) EP57	(2) EP37 (1) EP57	(1) EP37 (2) EP57	(3) EP57	(1) EP37 (3) EP57

For Solid Shelves\*:

Nominal Post Height (in.) (mm)	30" (760mm) Nominal Shelf Length	36" (914mm) Nominal Shelf Length	42" (1066mm) Nominal Shelf Length	48" (1219mm) Nominal Shelf Length	54" (1370mm) Nominal Shelf Length	60" (1524mm) Nominal Shelf Length	72" (1825mm) Nominal Shelf Length
54 1370	(1) EP55	(2) EP35	(1) EP35 (1) EP55	(2) EP55	N/A	(1) EP35	N/A
63 1600	(1) EP56	(2) EP36	(1) EP36 (1) EP56	(2) EP56	N/A	(1) EP36	N/A
74 1880	(1) EP57	(2) EP37	(2) EP37 (1) EP57	(2) EP57	N/A	(1) EP37	N/A

\*Note: Units with a solid shelf in the top position require the use of a three-sided double snake frame (see page 55) directly below it.



Super Adjustable Super Erecta Cart with Enclosure Panels



Mounting Kit for Enclosure Panel

Replacement Mounting Kit for Enclosure Panel

Cat. No. **9970EPZ**

**Rods and Tabs — 10.04**

Form side and back enclosures for a shelving unit. Can also serve as uniform dividers within unit by passing through shelves from top to bottom. Recommended spacing: every 6" (150mm) to 12" (305mm), depending upon shelf contents.

**Rods**

Min. Post Height (in.)	Rod Length		Approx. Pkd. Wt.		Cat. No. Plated	Cat. No. Stainless
	(in.)	(mm)	(lbs.)	(kg)		
54	52	1320	1	0.5	<b>R52C</b>	<b>R52S</b>
63	61	1549	1	0.5	<b>R61C</b>	<b>R61S</b>
74	72	1830	1 1/4	0.6	<b>R72C</b>	<b>R72S</b>
86	84	2135	1 1/2	0.7	<b>R84C</b>	<b>R84S</b>

**Tabs**  
Rods are shipped with 4 tabs per rod.

**Additional Tabs —**  
Bag of 12  
Cat. No. **9084Z**



Rod with Tab in place

**Three-Sided Double Snake Frames — 10.04**

Provide additional support or access to floor with these sturdy square snake frames. Plated finish.

Width/Length (in./mm)		Approx. Pkd. Wt. (lbs./kg)		Cat. No. Plated
18x24	457x610	5	2.3	
18x30	457x760	6	2.7	<b>SF32N3C</b>
18x36	457x914	6 1/2	2.7	<b>SF33N3C</b>
18x42	457x1066	7	3.2	<b>SF34N3C</b>
18x48	457x1219	7 3/4	3.5	<b>SF35N3C</b>
18x60	457x1524	8	3.6	<b>SF36N3C</b>
18x72	457x1829	9	4.1	<b>SF37N3C</b>
21x24	530x610	5	2.3	<b>SF41N3C</b>
21x30	530x760	6	2.7	<b>SF42N3C</b>
21x36	530x914	6 1/2	2.7	<b>SF43N3C</b>
21x42	530x1066	7	3.2	<b>SF44N3C</b>
21x48	530x1219	8	3.6	<b>SF45N3C</b>
21x60	530x1524	8 1/2	3.8	<b>SF46N3C</b>
21x72	530x1829	10	4.5	<b>SF47N3C</b>
24x24	610x610	6	2.7	<b>SF51N3C</b>
24x30	610x760	7	3.2	<b>SF52N3C</b>
24x36	610x914	7 1/2	3.4	<b>SF53N3C</b>
24x42	610x1066	8	3.6	<b>SF54N3C</b>
24x48	610x1219	9	4.1	<b>SF55N3C</b>
24x60	610x1524	10	4.5	<b>SF56N3C</b>
24x72	610x1829	11	5.0	<b>SF57N3C</b>



Three-sided Double Snake Frame

**Hanger Rails — 10.05**

Convenient rail fits on posts along the width or length of the unit. Optional hooks can hang from rail at any point.

Length† (in./mm)	Approx. Pkd. Wt. (lbs./kg)	Cat. No.				
		Chrome	Black	White	Smoked Glass	Designer Colors
14 355	1 .45	<b>H114C</b>	<b>H114B</b>	<b>H114W</b>	<b>H114-DSG</b>	<b>H114-D</b>
18 457	1 1/4 .57	<b>H118C</b>	<b>H118B</b>	<b>H118W</b>	<b>H118-DSG</b>	<b>H118-D</b>
24 610	1 1/2 .68	<b>H124C</b>	<b>H124B</b>	<b>H124W</b>	<b>H124-DSG</b>	<b>H124-D</b>
30 760	1 1/2 .68	<b>H130C</b>	<b>H130B</b>	<b>H130W</b>	<b>H130-DSG</b>	<b>H130-D</b>
36 914	2 .90	<b>H136C</b>	<b>H136B</b>	<b>H136W</b>	<b>H136-DSG</b>	<b>H136-D</b>
48 1219	2 1/2 1.13	<b>H148C</b>	<b>H148B</b>	<b>H148W</b>	<b>H148-DSG</b>	<b>H148-D</b>

†14", 18" and 24" (355, 457 and 610mm) sizes fit shelf width (depth). 30", 36" and 48" (760, 914 and 1219mm) sizes fit shelf length.



Hanger Rail



Decorator Shelf Inlays

Decorator Shelf Inlays — 10.06

Hardboard mats prevent small items from falling through wire shelves. Fit between posts and level with top of shelf edge. Reversible, black and white. Packed individually.

Width/Length (in.) (mm)		Cat. No.
14x36	355x914	1436BWI
14x48	355x1219	1448BWI
18x24	457x610	1824BWI
18x36	457x914	1836BWI
18x48	457x1219	1848BWI
24x24	610x610	2424BWI
24x36	610x914	2436BWI
24x48	610x1219	2448BWI



Clear Shelf Inlays

Clear Shelf Inlays — 10.06

Nearly invisible plastic mat retains open-wire look of shelves and allows light penetration. Sold in packages of 4.

Width/Length (in.) (mm)		Cat. No.
14x36	355x914	1436CI-4
14x48	355x1219	1448CI-4
14x60	355x1524	1460CI-4
18x36	457x914	1836CI-4
18x48	457x1219	1848CI-4
18x60	457x1524	1860CI-4

Width/Length (in.) (mm)		Cat. No.
21x36	530x914	2136CI-4
21x48	530x1219	2148CI-4
21x60	530x1524	2160CI-4
24x36	610x914	2436CI-4
24x48	610x1219	2448CI-4
24x60	610x1524	2460CI-4

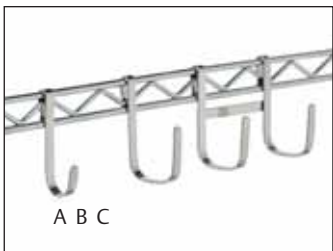

Snap-on Hooks

Snap-On Hooks — 10.05

Multi-purpose hooks in three styles attach to hanger rails, mounting rails or shelves for instant access.

Description	Height (in.) (mm)	Cat. No. Chrome	Cat. No. Black
Style A — Small	3 <sup>7</sup> / <sub>16</sub> 90	HK23C	HK23B
Style B — Large	3 <sup>7</sup> / <sub>16</sub> 90	HK25C	HK25B
Style C — Double	3 <sup>7</sup> / <sub>16</sub> 90	HK26C	



Garment Hanger Tube with Brackets

Garment Hanger Tube with Brackets — 10.05

Hanger tubes attach easily under Super Erecta shelves for hanging garments. Available in 18", 21" and 24" (457, 530 and 610mm) widths and in same length as shelves.

Tube Length (in.) (mm)	Approx. Pkd. Wt. (lbs.) (kg)	Shelf Width 18" (457mm)	Shelf Width 21" (530mm)	Shelf Width 24" (610mm)
24 610	2 <sup>1</sup> / <sub>2</sub> 1.1	AT2418NC	AT2421NC	AT2424NC
30 760	2 <sup>1</sup> / <sub>2</sub> 1.1	AT3018NC	AT3021NC	AT3024NC
36 914	3 1.4	AT3618NC	AT3621NC	AT3624NC
42 1066	3 <sup>1</sup> / <sub>2</sub> 1.6	AT4218NC	AT4221NC	AT4224NC
48 1219	3 <sup>1</sup> / <sub>2</sub> 1.6	AT4818NC	AT4821NC	AT4824NC
60 1524	4 1.8	AT6018NC	AT6021NC	AT6024NC
72 1828	4 <sup>1</sup> / <sub>2</sub> 2.0	AT7218NC	AT7221NC	AT7224NC



Tray Slides — 10.04

Free up shelves for more efficient use of space. Available in chrome and Metroseal 3 finish. 22<sup>3</sup>/<sub>4</sub>" H. (578mm).

Width		Overall Depth		Slide Profile		On Center Slide Spacing		Fits Shelf Width		Approx. Weight/Pair		Cat. No. Chrome	Cat. No. Metroseal 3 with Microban®
(in.)	(mm)	(in.)	(mm)	(in.)	(mm)	(in.)	(mm)	(in.)	(mm)	(lbs.)	(kg)		
14 <sup>5</sup> / <sub>8</sub>	371	2 <sup>1</sup> / <sub>4</sub>	56	1 <sup>1</sup> / <sub>2</sub>	37	1 <sup>1</sup> / <sub>2</sub>	37	18	457	9 <sup>1</sup> / <sub>2</sub>	4.3	15SNC	15SNK3
20	508	2 <sup>1</sup> / <sub>4</sub>	56	1 <sup>1</sup> / <sub>2</sub>	37	1 <sup>1</sup> / <sub>2</sub>	37	24	610	11	5.0	20SNC	20SNK3



Tray Slides

Super Erecta® Slide System — 10.04

A super space-saving solution. Using Super Erecta® wire units 21" or 24" (530 and 610mm) wide, tote boxes and this innovative slide system, you have the flexibility to create a custom configuration that can be positioned quickly on new or existing units without the use of tools. Finish is nickel-chrome wire with clear protective coating.

Outside Slide Dimensions Height/Width/Length		Fits Shelf Width		Adaptable Boxes	Approx. Pkd. Wt.		Cat. No.
(in.)	(mm)	(in.)	(mm)		(lbs.)	(kg)	
10 <sup>1</sup> / <sub>4</sub> x20 <sup>3</sup> / <sub>8</sub> x21 <sup>5</sup> / <sub>8</sub>	256x510x537	24	610	TB/MTB93030 TB/MTB93060 TB/MTB93080	4 <sup>3</sup> / <sub>4</sub>	2.1	SS2NC
10 <sup>1</sup> / <sub>4</sub> x14x17 <sup>1</sup> / <sub>8</sub>	256x355x430	21	530	TB/MTB92035 TB/MTB92060 TB/MTB92080	3 <sup>1</sup> / <sub>2</sub>	1.5	SS3NC
10 <sup>1</sup> / <sub>4</sub> x25 <sup>1</sup> / <sub>8</sub> x17 <sup>1</sup> / <sub>8</sub>	256x630x430	21	530	TB/MTB93030* TB/MTB93060* TB/MTB93080*	4	1.8	SS4NC

\*Fits SS4NC with box turned sideways.

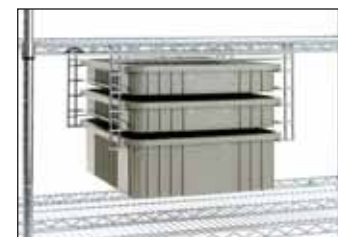

Super Erecta Slide System in place on shelf (Tote box sold separately)

Adjustable Undershelf Slides — 10.04

These slides can be spaced to fit any width container or tote box.

Item	Approx. Pkd. Wt.		Cat. No. (pair)
	(lbs.)	(kg)	
For 18" (457mm) wide shelf	1	0.4	US18NA
*For 21" (530mm) wide shelf	1	0.4	US21NA
For 24" (610mm) wide shelf	1	0.4	US24NA

\*Not adaptable to 24" (610mm) long shelf.



Adjustable Undershelf Slide

File Basket — 10.05

The convenient place to keep files and papers.

- Measures 2<sup>5</sup>/<sub>8</sub>" W. x 12<sup>3</sup>/<sub>4</sub>" L. x 8<sup>3</sup>/<sub>4</sub>" H. (67mm W. x 324mm L. x 222mm H.).
- Large enough to hold standard-size file folders.
- Attaches easily.

Width/Length		Height		Approx. Pkd. Wt.		Cat. No.
(in.)	(mm)	(in.)	(mm)	(lbs.)	(kg)	
2 <sup>5</sup> / <sub>8</sub> x12 <sup>3</sup> / <sub>4</sub>	63x330	8 <sup>3</sup> / <sub>4</sub>	228	2.1	1.0	PH1239C

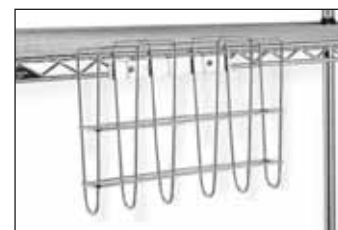

File Basket



Indicates antimicrobial product.



Large Display/Storage Basket

**Storage Baskets — 10.05**

Generous-sized baskets attach in seconds to hanger rail or shelves.

	Width/Length/Depth (in.)	Width/Length/Depth (mm)	Approx. Pkd. Wt.		Cat. No. Plated	Cat. No. Black	Cat. No. White	Cat. No. Smoked Glass	Cat. No. Designer Colors
			(lbs.)	(kg)					
	13 <sup>3</sup> / <sub>8</sub> x5x7	345x127x180	8 <sup>1</sup> / <sub>2</sub>	4	H209C	H209B	H209W	H209-DSG	H209-D
	17 <sup>3</sup> / <sub>8</sub> x7 <sup>1</sup> / <sub>2</sub> x5	440x190x127	7	3	H210C	H210B	H210W	H210-DSG	H210-D
	17 <sup>3</sup> / <sub>8</sub> x7 <sup>1</sup> / <sub>2</sub> x10	440x190x255	11	5	H212C	H212B	H212W	H212-DSG	H212-D

**Swing Hanger — 10.05**

Attaches to post to provide convenient storage for hanging items. Red epoxy finish.

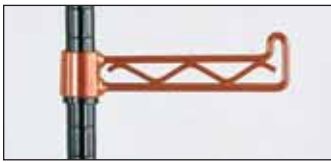

Swing Hanger

Arm Length (in.)	Arm Length (mm)	Weight Capacity		Cat. No.
		(lbs.)	(kg)	
6 <sup>1</sup> / <sub>4</sub>	160	20	9	H110R

**Extension Display Hanger — 10.05**

Snaps on Super Erecta Shelf hanger rails and shelf frames. Accepts standard carded merchandise.



Extension Display Hanger

Length (in.)	Length (mm)	Approx. Pkd. Wt.		Finish/Color*	Cat. No.
		(lbs.)	(kg)		
6	152	.25	.1	Chrome	HHK6C
6	152	.25	.1	Black	HHK6B
8	203	.25	.1	Chrome	HHK8C
8	203	.25	.1	Black	HHK8B

\*White, smoked glass and designer colors also available. Allow 4-6 week lead time.



Color Identification Tubes

**Color Identification Tubes — 10.05**

Provide color-coded organization to shelf contents. Tubes slip onto posts.

Length (in.)	Length (mm)	Diameter		Approx. Pkd. Wt.	Color	Cat. No.	
		Inside (in.)	Outside (mm)				
8	200	1 <sup>1</sup> / <sub>16</sub>	27	5 <sup>5</sup> / <sub>8</sub>	2.5	Yellow	CIT8Y
8	200	1 <sup>1</sup> / <sub>16</sub>	27	1 <sup>3</sup> / <sub>16</sub>	30	Flame	CIT8F
8	200	1 <sup>1</sup> / <sub>16</sub>	27	1 <sup>3</sup> / <sub>16</sub>	30	Black	CIT8BL
8	200	1 <sup>1</sup> / <sub>16</sub>	27	1 <sup>3</sup> / <sub>16</sub>	30	Gray	CIT8G
8	200	1 <sup>1</sup> / <sub>16</sub>	27	1 <sup>3</sup> / <sub>16</sub>	30	White	CIT8W

**Color Shelf Marker — 10.05**

Color code for effective organization. Snaps securely to the front edge of Super Erecta and Super Adjustable Super Erecta Wire Shelving.

Shelf Marker Size		Color	Cat. No.
(in.)	(mm)		
6x1 <sup>1</sup> / <sub>4</sub>	152x32	Blue	<b>CSM6-B</b>
6x1 <sup>1</sup> / <sub>4</sub>	152x32	Green	<b>CSM6-G</b>
6x1 <sup>1</sup> / <sub>4</sub>	152x32	Red	<b>CSM6-R</b>
6x1 <sup>1</sup> / <sub>4</sub>	152x32	Tan	<b>CSM6-T</b>

Shelf Marker Size		Color	Cat. No.
(in.)	(mm)		
6x1 <sup>1</sup> / <sub>4</sub>	152x32	White	<b>CSM6-W</b>
6x1 <sup>1</sup> / <sub>4</sub>	152x32	Yellow	<b>CSM6-Y</b>
6x1 <sup>1</sup> / <sub>4</sub>	152x32	Gray	<b>CSM6-GR</b>



Color Shelf Markers



CSM6-B



CSM6-G



CSM6-R



CSM6-T



CSM6-W



CSM6-Y



CSM6-GR

**Label Holders**

It's easy to identify shelf contents with these snap-on plastic holders, available in four styles and a variety of sizes. Labels not included.

**1<sup>1</sup>/<sub>4</sub>" (32mm) Label Holders — 10.05**

Gray. Holds most commercial labels. Available in a variety of lengths.

Label Size		Fits Shelf Length		Cat. No.
(in.)	(mm)	(in.)	(mm)	
3x1 <sup>1</sup> / <sub>4</sub>	75x32	All		<b>9990P</b>
13x1 <sup>1</sup> / <sub>4</sub>	330x32	18	457	<b>9990P1</b>
19x1 <sup>1</sup> / <sub>4</sub>	480x32	24	610	<b>9990P2</b>
25x1 <sup>1</sup> / <sub>4</sub>	635x32	30	760	<b>9990P30</b>
31x1 <sup>1</sup> / <sub>4</sub>	725x32	36	914	<b>9990P3</b>
43x1 <sup>1</sup> / <sub>4</sub>	1090x32	48	1219	<b>9990P4</b>
55x1 <sup>1</sup> / <sub>4</sub>	1395x32	60	1520	<b>9990P5</b>

For Cantilever Shelves, use 3" (75mm) label holder only.



1<sup>1</sup>/<sub>4</sub>" (32mm) Label Holder

**Clear Label Holders — 10.05**

Clear plastic allows decorator colors to show through. Holds most commercial 1<sup>1</sup>/<sub>4</sub>" (32mm) labels.

Label Size		Fits Shelf Length		Cat. No.
(in.)	(mm)	(in.)	(mm)	
3x1 <sup>1</sup> / <sub>4</sub>	75x32	All		<b>9990CL</b>
13x1 <sup>1</sup> / <sub>4</sub>	330x32	18	457	<b>9990CL1</b>
19x1 <sup>1</sup> / <sub>4</sub>	480x32	24	610	<b>9990CL2</b>
25x1 <sup>1</sup> / <sub>4</sub>	635x32	30	760	<b>9990CL30</b>
31x1 <sup>1</sup> / <sub>4</sub>	725x32	36	914	<b>9990CL3</b>
43x1 <sup>1</sup> / <sub>4</sub>	1090x32	48	1219	<b>9990CL4</b>
55x1 <sup>1</sup> / <sub>4</sub>	1395x32	60	1520	<b>9990CL5</b>

For Cantilever Shelves, use 3" (75mm) label holder only.



Clear Label Holder

**Slanted Label Holders — 10.05**

Gray solid plastic holder puts 1<sup>1</sup>/<sub>4</sub>" (32mm) labels on slant for easier viewing.

Label Size		Fits Shelf Length		Cat. No.
(in.)	(mm)	(in.)	(mm)	
3x1 <sup>1</sup> / <sub>4</sub>	75x32	All		<b>9990SL</b>
13x1 <sup>1</sup> / <sub>4</sub>	330x32	18	457	<b>9990SL1</b>
19x1 <sup>1</sup> / <sub>4</sub>	480x32	24	610	<b>9990SL2</b>
25x1 <sup>1</sup> / <sub>4</sub>	635x32	30	760	<b>9990SL30</b>
31x1 <sup>1</sup> / <sub>4</sub>	725x32	36	914	<b>9990SL3</b>
43x1 <sup>1</sup> / <sub>4</sub>	1090x32	48	1219	<b>9990SL4</b>
55x1 <sup>1</sup> / <sub>4</sub>	1395x32	60	1520	<b>9990SL5</b>

For Cantilever Shelves, use 3" (75mm) label holder only.



Slanted Label Holder

**Metro Bins — 10.08**

Convenient way to organize and identify small items.

- Hopper-front design allows for easy access and clear visibility
- Lightweight, durable polypropylene and polyethylene bins have molded front slots to accept labels.
- For application specific totes refer to index.



Shelf Bins — Nesting

**Shelf Bins — Nesting**

These bins are sized to work on the two most popular shelf widths 18" (457mm) and 24" (610mm) for efficient handling and exchange.

Outside Dimensions Width/Length/Height (in.)	Outside Dimensions Width/Length/Height (mm)	Approx. Pkd.23 Wt./Ctn. (lbs.) (kg)		Bin Carton Quantity	Color	Bin Cat. No.	Divider Cat. No.	Divider Carton Quantity
11 <sup>5</sup> / <sub>8</sub> x4 <sup>1</sup> / <sub>8</sub> x4	295x105x102	9	4.1	24	Yellow	MB30120Y	MB40120	24
11 <sup>5</sup> / <sub>8</sub> x6 <sup>1</sup> / <sub>8</sub> x4	295x168x102	7	3.2	12	Yellow	MB30130Y	MB40130	24
17 <sup>7</sup> / <sub>8</sub> x4 <sup>1</sup> / <sub>8</sub> x4	454x105x102	7	3.2	12	Yellow	MB30128Y	MB40120	24
17 <sup>7</sup> / <sub>8</sub> x6 <sup>5</sup> / <sub>8</sub> x4	454x168x102	9	4.1	12	Yellow	MB30138Y	MB40130	24
17 <sup>7</sup> / <sub>8</sub> x11 <sup>1</sup> / <sub>8</sub> x4	454x283x102	15	6.8	12	Yellow	MB30178Y	MB40170	24
23 <sup>5</sup> / <sub>8</sub> x4 <sup>1</sup> / <sub>8</sub> x4	600x105x102	11	4.9	12	Yellow	MB30124Y	MB40120	24
23 <sup>5</sup> / <sub>8</sub> x6 <sup>5</sup> / <sub>8</sub> x4	600x168x102	8	3.6	6	Yellow	MB30164Y	MB40130	24
23 <sup>5</sup> / <sub>8</sub> x11 <sup>1</sup> / <sub>8</sub> x4	600x283x102	11	4.9	6	Yellow	MB30174Y	MB40170	24

**Note:** Bins are available in carton quantities only. Bins above are priced per each but must be ordered in multiples of carton quantity. (For example: MB30138Y is available in quantities of 12, 24, 36. List price refers to the price of 1 bin.) Dividers are available in carton quantities only. Dividers are sold by the carton and priced by the carton. (For example: 1 MB40120 = 24 dividers, the list price is for 24 dividers.)



Supply Bins — Stacking

**Supply Bins — Stacking**

Stackable design maximizes vertical storage efficiency. Reinforced design adds strength and prevents spreading.

Outside Dimensions Width/Length/Height (in.)	Outside Dimensions Width/Length/Height (mm)	Approx. Pkd. Wt./Ctn. (lbs.) (kg)		Bin Carton Quantity	Color	Bin Cat. No.	Divider Cat. No.	Divider Carton Quantity
10 <sup>7</sup> / <sub>8</sub> x5 <sup>1</sup> / <sub>2</sub> x5	276x140x127	10	4.5	12	Blue	MB30230B	MB40230	6
10 <sup>7</sup> / <sub>8</sub> x11x5	276x279x127	10	4.5	6	Blue	MB30235B	MB40230	6
14 <sup>3</sup> / <sub>4</sub> x5 <sup>1</sup> / <sub>2</sub> x5	375x140x127	13	5.9	12	Blue	MB30234B	N/A	
14 <sup>3</sup> / <sub>4</sub> x8 <sup>1</sup> / <sub>4</sub> x7	375x210x178	24	10.9	12	Blue	MB30240B	MB40245	6
14 <sup>3</sup> / <sub>4</sub> x16 <sup>1</sup> / <sub>2</sub> x7	375x419x178	21	9.5	6	Blue	MB30250B	MB40245	6
18x8 <sup>1</sup> / <sub>4</sub> x9	457x210x229	17	7.7	6	Blue	MB30265B*	MB40265	6
20x12 <sup>3</sup> / <sub>8</sub> x6	508x314x203	9	4.1	3	Blue	MB30281B*	N/A	
20x18 <sup>3</sup> / <sub>8</sub> x12	508x467x305	7	3.2	1	Blue	MB30283B*	N/A	
8x20 <sup>1</sup> / <sub>2</sub> x7	205x521x178	21	9.5	6	Tan	MB30348T†		

\*MB30265B, MB30281B, MB30283B are not designed for use with hanging rail system. †Includes two dividers.

**Note:** MB30234B, MB30281B, MB30283B — no dividers available.

Bins feature a full-width hanger lip that is designed for use with hanging systems.

Bins are available in carton quantities only. Bins above are priced per each but must be ordered in multiples of carton quantity.

(For example: MB30235B is available in quantities of 6, 12, 18. List price refers to the price of 1 bin.)

Dividers are available in carton quantities only. Dividers are sold by the carton and priced by the carton.

(For example: 1 MB40230 = 6 dividers, the list price is for 6 dividers.)



MB30265B



MB30283B



MB34240G

**Bulk Supply Tub — Nesting**

Ruggedly constructed, perfect for storing large bulky items.

Outside Dimensions Width/Length/Height (in.)	Outside Dimensions Width/Length/Height (mm)	Approx. Pkd. Wt./Ctn. (lbs.) (kg)		Carton Quantity	Bin Color	Cat. No.
24 <sup>1</sup> / <sub>2</sub> x19x9 <sup>1</sup> / <sub>2</sub>	622x483x241	20	9.1	6	Gray	MB34240G

**Note:** Bins are available in carton quantities only. Bins above are priced per each but must be ordered in multiples of carton quantity. (For example: MB34240G is available in quantities of 6, 12, 18 etc. List price refers to the price of 1 bin.)

## Shelving and Cart Covers — 11.80

### Opaque Solid Fabric Covers

Protect contents from dust and other airborne contaminants.

- Deter pilferage: Allow units to be loaded prior to transport.
- Available in:
  - Uncoated White (100% knitted polyester)
  - Coated White (waterproof vinyl-nylon)
  - Uncoated Mariner Blue (200 denier nylon)
  - Coated Mariner Blue (waterproof vinyl-nylon)
- Choice of Velcro® or zipper closures.

Catalog numbers shown are for white cover. Add "MB" suffix to order Mariner Blue (i.e. 21X48X54UCMB)



21X48X54UCMB  
(shown in Mariner Blue)

Length/Height (in.)	Length/Height (mm)	White Nylon Uncoated		White Vinyl Coated	
		Zippered Closure Cat. No.	Price	Zippered Closure Cat. No.	Velcro Closure Cat. No.
<b>FOR SHELF TRUCKS &amp; CARTS 18" (457mm) DEEP</b>					
36x54	914x1370	18X36X54UC		18X36X54VUC	18X36X54C
36x62	914x1550	18X36X62UC		18X36X62VUC	18X36X62C
48x54	1219x1370	18X48X54UC		18X48X54VUC	18X48X54C
48x62	1219x1550	18X48X62UC		18X48X62VUC	18X48X62C
60x54	1524x1370	18X60X54UC		18X60X54VUC	18X60X54C
60x62	1524x1550	18X60X62UC		18X60X62VUC	18X60X62C
<b>FOR SHELF TRUCKS &amp; CARTS 21" (530mm) DEEP</b>					
48x54	1219x1370			21X48X54VUC	21X48X54C
48x62	1219x1550			21X48X62VUC	21X48X62C
48x74	1219x1850			21X48X74VUC	21X48X74C
60x54	1524x1370			21X60X54VUC	21X60X54C
60x62	1524x1550			21X60X62VUC	21X60X62C
60x74	1524x1850			21X60X74VUC	21X60X74C
<b>FOR SHELF TRUCKS &amp; CARTS 24" (610mm) DEEP</b>					
36x54	914x1370			24X36X54VUC	24X36X54C
36x62	914x1550			24X36X62VUC	24X36X62C
36x74	914x1850			24X36X74VUC	24X36X74C
48x54	1219x1370			24X48X54VUC	24X48X54C
48x62	1219x1550			24X48X62VUC	24X48X62C
48x74	1219x1850			24X48X74VUC	24X48X74C
60x54	1524x1370			24X60X54VUC	24X60X54C
60x62	1524x1550			24X60X62VUC	24X60X62C
60x74	1524x1850			24X60X74VUC	24X60X74C
72x54	1825x1370			24X72X54VUC	24X72X54C
72x62	1825x1550			24X72X62VUC	24X72X62C
72x74	1825x1850			24X72X74VUC	24X72X74C

\*Cart covers are non-returnable.

Note: 86" (2185mm) high covers, in 24" (610mm) depth, available by special order.

### Clear Vinyl Cart Covers

- Allows visual access while protecting shelf contents from dust and other airborne contaminants.
- Vinyl construction with Velcro closures.
- Available for 18x36" (457x914mm) shelving.

Length/Height (in.)	Length/Height (mm)	Cat. No.
36x32	914x889	<b>GWVC41</b>
36x52	914x1320	<b>GWVC62</b>



Clear Vinyl  
Cart Cover

☑ Indicates antimicrobial product.



Keyboard Tray

**Keyboard Tray — 10.06**

Attaches to all Metro wire shelves, 36" (914mm) length or longer. Mouse Tray adapts to left or right of Keyboard Tray. Flip-top compartment provides convenient storage. Constructed of durable high-impact polystyrene. Assembles easily.

- Hardware included for attachment to Metro wire shelves; template provided for attachment to solid desk surfaces.
- Keyboard Tray Dimensions: 22" L. (559mm) x 15 1/2" W. (394mm).
- Dimension with Mouse Tray fully extended: 29 1/2" L. (749mm) x 15 1/2" W. (394mm).

Cat. No. **CKS1522BL**  
List Price 80.00 each



Wire Management Clip

**Wire Management Clip — 10.06**

Keeps wires and cables neatly organized both horizontally and vertically. Easily snaps over the edge of any Super Erecta wire or qwikSLOT shelf. Black epoxy finish.

Width		Length		Approx. Pkd. Wt.		Cat. No.
(in.)	(mm)	(in.)	(mm)	(lbs.)	(kg)	
2	51	2	51	.5	.25	<b>CWM</b>

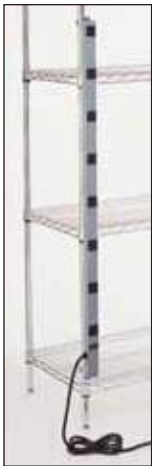

Power Strip

**Power Strip — 10.06**

- Mounts quickly and easily to either a Super Erecta or qwikSLOT post.
- Includes a 15 foot (4572mm) long cord.
- Mounting brackets and hardware included.
- UL/CSA approved.
- 15 Amp Circuit Breaker.
- Illuminated Power Switch. 15A/125VAC.60Hz/1875 W.
- Gray/blue finish.
- 14/3 SJT Molded Power Supply Cord.

Width		Length		Approx. Pkd. Wt.		Cat. No.
(in.)	(mm)	(in.)	(mm)	(lbs.)	(kg)	
1 1/2	38	48	1219	6	2.72	<b>CPS48</b>

**Surface Mount Swing Arm for Flat Monitor — 10.06**

Cat. No. **LTFMA**

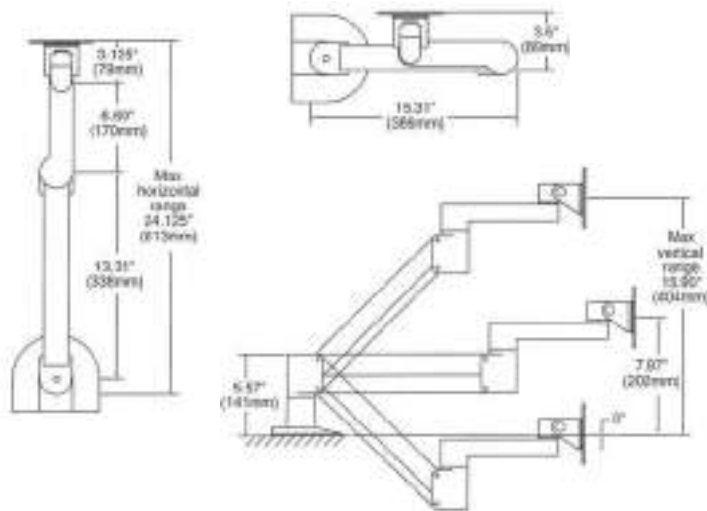



*Call today!*

**1.800.992.1776**

*A customer service representative is standing by to assist you.*



Not in the USA? Look on the back cover of your catalog for the contact information you need.

“Thank you for calling Metro, how can we help you?”



## Super Erecta® Solid Shelving

### Setting the standard for solid shelving.

Perfect for applications involving spillage. Provides barrier between floor and bottom shelf contents to deter contamination.

- Shelf design features a 1/8" (3.2mm) raised "ship's edge" on all four sides to contain spills.
- Louvered/embossed shelf allows air circulation.
- Available in several styles and materials for a variety of applications. Shelves are constructed with 18-gauge stainless steel (Type 304) or galvanized materials.
- **Galvanized shelves** with uncoated cast corners are ideal for applications requiring a solid shelving or work surface and minimum resistance to corrosion. Available in flat solid and louvered/embossed styles.
- **Standard Stainless Steel solid shelves** (Type 304) with epoxy-coated cast corners address the majority of applications for solid, corrosion resistant shelves or work surfaces. Available in flat solid and louvered/embossed styles.
- **Premium Autoclave/Cart Washable Stainless Steel solid shelves** (Type 304) feature an all-stainless construction to withstand high temperature, corrosive applications. Available in flat solid style.



Flat Solid Stainless Shelves with black powder-coated corners

**Metro Tip:**  
Use Metro Flat Solid Shelving at the bottom of a storage unit to maintain cleanliness by providing a barrier between floor and shelf contents above.

### SiteSelect Posts for Super Erecta® Solid Shelving — 10.20

Stationary posts are fitted with adjustable leveling bolts to compensate for uneven surfaces. Mobile posts come without leveling bolt to accommodate stem casters. Special length posts are available.†

Height*		Approx. Pkd. Wt.		Cat. No. Chrome Stationary	Cat. No. Chrome Mobile	Cat. No. Stainless Stationary**	Cat. No. Stainless Mobile
(in.)	(mm)	(lbs.)	(kg)				
7 1/2	191	1/2	0.3	<b>7P</b>	<b>7UP</b>		
14 1/2	370	1	0.5	<b>13P</b>	<b>13UP</b>	<b>13PS</b>	<b>13UPS</b>
27 1/2	699	1 3/4	0.75	<b>27P</b>	<b>27UP</b>	<b>27PS</b>	<b>27UPS</b>
34 1/2	875	2	0.9	<b>33P</b>	<b>33UP</b>	<b>33PS</b>	<b>33UPS</b>
54 9/16	1385	3	1.4	<b>54P</b>	<b>54UP</b>	<b>54PS</b>	<b>54UPS</b>
62 9/16	1590	3 1/2	1.6	<b>63P</b>	<b>63UP</b>	<b>63PS</b>	<b>63UPS</b>
74 5/8	1895	4	1.8	<b>74P</b>	<b>74UP</b>	<b>74PS</b>	<b>74UPS</b>
86 5/8	2200	5	2.3	<b>86P</b>	<b>86UP</b>	<b>86PS</b>	<b>86UPS</b>
96 5/8	2454	5 1/2	2.5	<b>***96P</b>			

†Note: Special length posts are available, priced at next higher length plus a cutting charge. Post lengths to be specified as cut to a round number, ie: 74P cut to 69" (1753mm) . . . This will result in an overall post height with adjustment of 69 9/8" (1762mm) to 69 5/8" (1775mm).  
\*Height includes leveling bolt and cap.  
\*\*Stainless stationary post includes stainless leveling bolt.  
\*\*\*96P should not be used on units less than 24" (610mm) deep. Consult Metro Engineering for alternate recommendations.



SiteSelect™ Posts are grooved at 1" (25mm) increments and numbered at 2" (50mm) increments. Posts are double-grooved every 8" (203mm) for easy identification.



Super Erecta® Solid Shelving — 10.20

Shelves are priced and sold individually. For standard packaging, the number of shelves per box varies by size. 14"/18" (355/457mm) wide solid shelving: less than 60" (1524mm) long (no more than 4 per carton); 60" (1524mm) long (no more than 2 per carton); 21" (530mm) wide solid shelving: less than 42" (1066mm) long (no more than 4 per carton); 42" (1066mm) or longer (no more than 2 per carton); 24" (610mm) wide solid shelving: 24", 30" (610, 760mm) long (no more than 4 per carton); 36" (914mm) or longer (no more than 2 per carton). Galvanized solid shelving has uncoated, aluminum cast corners. Standard Stainless Steel solid shelving has black powder-coated corners. Autoclavable/Cart-Washable Stainless Steel solid shelving has stainless steel corners.

Width/Length (in.) (mm)	Approx. Pkd. Wt. per Shelf (lbs.) (kg)	GALVANIZED		STANDARD STAINLESS STEEL			
		Cat. No. Flat	Cat. No. Louvered/Embossed	Cat. No. Flat	Cat. No. Louvered/Embossed		
14x24	355x610	10	4.5	1424FG	1424LG	1424FS	1424LS
14x30	355x760	12	5.4	1430FG	1430LG	1430FS	1430LS
14x36	355x914	14	6.4	1436FG	1436LG	1436FS	1436LS
14x42	355x1066	15	6.8	1442FG	1442LG	1442FS	1442LS
14x48	355x1219	17	7.7	1448FG	1448LG	1448FS	1448LS
14x60	355x1524	22	9.9	1460FG	1460LG	1460FS	1460LS
18x24	457x610	11	5.0	1824FG	1824LG	1824FS	1824LS
18x30	457x760	14	6.4	1830FG	1830LG	1830FS	1830LS
18x36	457x914	16	7.3	1836FG	1836LG	1836FS	1836LS
18x42	457x1066	18	8.2	1842FG	1842LG	1842FS	1842LS
18x48	457x1219	20	9.1	1848FG	1848LG	1848FS	1848LS
18x60	457x1524	24	10.9	1860FG	1860LG	1860FS	1860LS
21x24	530x610	13	5.9	2124FG	2124LG	2124FS	2124LS
21x30	530x760	15	6.8	2130FG	2130LG	2130FS	2130LS
21x36	530x914	18	8.2	2136FG	2136LG	2136FS	2136LS
21x42	530x1066	21	9.5	2142FG	2142LG	2142FS	2142LS
21x48	530x1219	23	10.4	2148FG	2148LG	2148FS	2148LS
21x60	530x1524	26	11.8	2160FG	2160LG	2160FS	2160LS
24x24	610x610	15	6.8	2424FG	2424LG	2424FS	2424LS
24x30	610x760	17	7.7	2430FG	2430LG	2430FS	2430LS
24x36	610x914	19	8.6	2436FG	2436LG	2436FS	2436LS
24x42	610x1066	21	9.5	2442FG	2442LG	2442FS	2442LS
24x48	610x1219	24	10.9	2448FG	2448LG	2448FS	2448LS
24x60	610x1524	31	14.0	2460FG	2460LG	2460FS	2460LS

Autoclavable/Cart-Washable Solid Stainless Shelving

All-stainless construction will address autoclave and cart washing applications.

Width/Length (in.) (mm)	Approx. Pkd. Wt. per Shelf (lbs.) (kg)	Autoclavable Stainless		Width/Length (in.) (mm)	Approx. Pkd. Wt. per Shelf (lbs.) (kg)	Autoclavable Stainless			
		Cat. No.	Cat. No.			Cat. No.	Cat. No.		
14x24	355x610	10	4.5	1424NFS	21x24	530x610	13	5.9	2124NFS
14x30	355x760	12	5.4	1430NFS	21x30	530x760	15	6.8	2130NFS
14x36	355x914	14	6.4	1436NFS	21x36	530x914	18	8.2	2136NFS
14x42	355x1066	15	6.8	1442NFS	21x42	530x1066	21	9.5	2142NFS
14x48	355x1219	17	7.7	1448NFS	21x48	530x1219	23	10.4	2148NFS
14x60	355x1524	22	9.9	1460NFS	21x60	530x1524	26	11.8	2160NFS
18x24	457x610	11	5.0	1824NFS	24x24	610x610	15	6.8	2424NFS
18x30	457x760	14	6.4	1830NFS	24x30	610x760	17	7.7	2430NFS
18x36	457x914	16	7.3	1836NFS	24x36	610x914	19	8.6	2436NFS
18x42	457x1066	18	8.2	1842NFS	24x42	610x1066	21	9.5	2442NFS
18x48	457x1219	20	9.1	1848NFS	24x48	610x1219	24	10.9	2448NFS
18x60	457x1524	24	10.9	1860NFS	24x60	610x1524	31	14.0	2460NFS

**Metro Tip:**  
Order aluminum split sleeves with stainless C-rings for corrosive, high-temperature autoclave or cart washing applications. (Cat. No. 9986S, one bag required per shelf).



Counter Unit with galvanized shelves.

Super Erecta® Counter Units — 10.35

To create a counter unit, select the following components:  
 2 each — 14" (355mm) deep upper shelves, listed above  
 2 each — 24" (610mm) deep lower shelves, listed above  
 2 each — upper front posts, listed below  
 2 each — lower front posts, listed below  
 2 each — 63" (1600mm) or 74" (1880mm) high back posts (page 64).

Special Posts For Counter Units — 10.35

	Unit Height (in.) (mm)	Post Height* (in.) (mm)	Approx. Pkd. Wt. (lbs.) (kg)	Cat. No. Plated	Cat. No. Stainless
Upper Front Posts	63 1600	28 <sup>5</sup> / <sub>8</sub> 727	1 <sup>1</sup> / <sub>2</sub> 0.7	27PF	27PFS
	74 1880	40 <sup>5</sup> / <sub>8</sub> 1032	2 0.9	39PF	39PFS
Lower Front Posts	All Heights	34 <sup>1</sup> / <sub>2</sub> 877	2 0.9	33PF	33PFS

\*Height includes leveling bolt and cap.

**Shelf Ledges for Solid Shelves — 10.25**

Sturdy 4" (101mm) ledges contain items on shelves. Spring-clip tabs included for attachment.



4" (101mm) Ledges

Fits Shelf Length		Approx. Pkd. Wt. Per 6 Pieces		Cat. No. Plated	Cat. No. Stainless
(in.)	(mm)	(lbs.)	(kg)		
14	355	7½	3.4	L14WC	L14WS
18	457	9	4.1	L18WC	L18WS
21	530	10½	4.7	L21WC	L21WS
24	610	12	5.4	L24WC	L24WS
30	760	13½	6.0	L30WC	L30WS
36	914	16½	7.4	L36WC	L36WS
42	1066	19½	8.7	L42WC	L42WS
48	1219	22½	10.1	L48WC	L48WS
60	1524	30	13.5	L60WC	L60WS

\*Actual ledge length is approximately 1" (25mm) shorter than nominal shelf length/width.

**Rods and Tabs for Solid Shelves — 10.25**

Create a more versatile system by enclosing sides and back of an entire unit. Tabs required to attach rods to a 4-shelf unit are supplied. Additional tabs also available in bags of 6.



Rods with Tab in place

**Rods**

Min. Post Height	Rod Length		Approx. Pkd. Wt.		Cat. No. Plated
	(in.)	(mm)	(lbs.)	(kg)	
54	52	1320	1	0.5	R52FC
63	60	1524	1	0.5	R60FC
74	72	1830	1¼	0.6	R72FC
86	84	2135	1½	0.7	R84FC

Additional Tabs  
Bag of 6  
Cat. No. **9184Z**

**Shelf Dividers — 10.25**

The easy way to keep shelves orderly. Eight inch (203mm) high dividers attach with spring clips (provided).



Shelf Dividers

Length		Approx. Pkd. Wt. Per 6 Pieces		Cat. No. Plated	Cat. No. Stainless
(in.)	(mm)	(lbs.)	(kg)		
14	355	12	5.4	DD14FC	
18	457	13½	6.0	DD18FC	DD18FS
21	530	15	6.8	DD21FC	
24	610	16½	7.4	DD24FC	DD24FS

**Solid Shelf Joining Clamp — 10.25**

Save time and money by eliminating adjacent posts and replacing with solid shelf joining clamps. Join units end-to-end, back-to-back or at right angles. Two clamps required per shelf to attach to adjacent units.

Zinc. Cat. No. **9998Z**



Joining Clamp

**Note:** Shelves with joining clamps can only be attached to shelves supported by two or more posts.

**Adjustable Undershelf Slides — 10.25**

Create a convenient drawer system by combining a tote box with these slides. Two slides are required, and can be spaced to fit any width container.



Adjustable Undershelf Slides

Item	Approx. Pkd. Wt.		Cat. No. Solid
	(lbs.)	(kg)	
For 18" (457mm) wide shelf	1	0.4	US18FA
For 21" (530mm) wide shelf	1	0.4	US21FA
For 24" (610mm) wide shelf	1	0.4	US24FA

\*For application-specific totes, refer to index.

## Erecta Shelf® Shelving

This easy-to-assemble system puts space to work practically anywhere.

- Units go together without tools — shelf grooves simply lock into uprights at 5" (127mm) increments.
- Accessories create a truly versatile system.

### Erecta Shelf® Uprights — 10.50

Width/Length		Approx. Pkd. Wt.		Cat. No. Chrome
(in.)	(mm)	(lbs.)	(kg)	
12x53½	305x1359	7	3.2	1252C
12x63½	305x1613	8	3.3	1262C
12x73½	305x1867	9	4.1	1272C
12x88½	305x2248	11	5.0	1287C
18x53½	457x1359	8	3.3	1852C
18x63½	457x1613	9	4.1	1862C
18x73½	457x1867	11	5.0	1872C
18x88½	457x2248	13½	6.2	1887C

Packaging: 6 uprights to a carton.

### Erecta Shelf® Wire Shelves — 10.50

Width/Length		Approx. Pkd. Wt.		Cat. No. Chrome
(in.)	(mm)	(lbs.)	(kg)	
12x24	305x610	5	2.2	1224C
12x30	305x760	6	2.7	1230C
12x36	305x914	7	3.1	1236C
12x42	305x1066	8¼	3.7	1242C
12x48	305x1219	9½	4.2	1248C
12x60	305x1524	12	5.4	1260C
18x24	457x610	6½	2.9	1824C
18x30	457x760	8	3.6	1830C
18x36	457x914	10	4.5	1836C
18x42	457x1066	11	4.9	1842C
18x48	457x1219	12½	5.6	1848C
18x60	457x1524	16	7.2	1860C

### Shelf Dividers — 10.56

Keep shelves orderly with these snap-in-place, 8" (203mm) high dividers.

Shelf Width (in.)	(mm)	Approx. Pkd. Wt.		Cat. No. Plated
		Per 6 Pieces (lbs.)	(kg)	
12	305	12	5.4	DD12C
18	457	13½	6.1	DD18C
24	610	16½	7.4	DD24C

### Corner Braces

Join units at right angles and eliminate the need for one upright with the use of two corner braces per shelf.

Cat. No. 9999Z



Shelf Divider



Corner Brace



HD Super Solid Stainless Shelving with black powder-coated corners

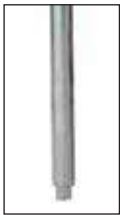

HD Super Post



HD Super Stem Caster Post



HD Super Stem Caster

Stainless solid shelving has black powder-coated corners. Galvanized solid shelving has uncoated cast corners.

HD Super™ shelves, posts, and casters are not compatible with Super Erecta or Super Adjustable Super Erecta components.

## HD Super™ Solid Shelving

Heavy-duty system features 16-gauge solid shelves.

- Large 1<sup>5</sup>/<sub>8</sub>" (41 mm) diameter posts and 2" (51 mm) shelf adjustability.
- Shelf options include flat or louvered/embossed styles, and galvanized or stainless steel finishes.

### HD Super Flat Shelves — 10.65

Width/Length (in.) (mm)		Approx. Pkd. Wt. (lbs.) (kg)		Cat. No. Galvanized	Cat. No. Stainless
18x36	457x914	21	9.5	1836HFG	1836HFS
18x42	457x1066	23	10.4	1842HFG	1842HFS
18x48	457x1219	26	11.7	1848HFG	1848HFS
18x54	457x1370	28	12.7	1854HFG	1854HFS
18x60	457x1524	31	14.0	1860HFG	1860HFS
24x36	610x914	25	11.3	2436HFG	2436HFS
24x42	610x1066	29	13.1	2442HFG	2442HFS
24x48	610x1219	32	14.4	2448HFG	2448HFS
24x54	610x1370	35	15.8	2454HFG	2454HFS
24x60	610x1524	38	17.1	2460HFG	2460HFS

### HD Super Louvered/Embossed Shelves — 10.65

Width/Length (in.) (mm)		Approx. Pkd. Wt. (lbs.) (kg)		Cat. No. Stainless
18x36	457x914	21	9.5	1836HLS
18x42	457x1066	23	10.4	1842HLS
18x48	457x1219	26	11.7	1848HLS
18x54	457x1370	28	12.7	1854HLS
18x60	457x1524	31	14.0	1860HLS
24x36	610x914	25	11.3	2436HLS
24x42	610x1066	29	13.1	2442HLS
24x48	610x1219	32	14.4	2448HLS
24x54	610x1370	35	15.8	2454HLS
24x60	610x1524	38	17.1	2460HLS

**Note:** The weight capacity of a HD Super Shelf is 1,000 lbs. (457kg) per shelf, evenly distributed across shelf.

### HD Super Stationary Posts — 10.65

Height* (in.) (mm)	Approx. Pkd. Wt. (lbs.) (kg)	Cat. No. Chrome	Cat. No. Stainless
56 1421	5.8 2.6	54HPC	54HPS
64 1624	6.3 2.9	63HPC	63HPS
76 1929	7.5 3.4	74HPC	74HPS

\*Height includes leveling foot and cap.

**Note:** Special length posts are available. For more information, contact your Metro representative.

**Packaging:** 4 posts to a carton.

### HD Super Stem Caster Posts — 10.65

Height (in.) (mm)	Approx. Pkd. Wt. (lbs.) (kg)	Cat. No. Chrome	Cat. No. Stainless
54 <sup>9</sup> / <sub>16</sub> 1386	5.7 2.5	54UHPC	54UHPS
62 <sup>9</sup> / <sub>16</sub> 1590	6.3 2.8	63UHPC	63UHPS
74 <sup>5</sup> / <sub>8</sub> 1894	7.5 3.3	74UHPC	74UHPS

### HD Super Stem Casters — 10.65

Includes donut bumpers with each caster.

Wheel Diameter (in.) (mm)	Face Diameter (in.) (mm)	Type	Wheel Tread	Approx. Pkd. Wt. (lbs.) (kg)	Cat. No.
5 127	1 <sup>1</sup> / <sub>2</sub> 38.1	Swivel	Polyurethane	3 <sup>1</sup> / <sub>2</sub> 1.5	5HHP
5 127	1 <sup>1</sup> / <sub>2</sub> 38.1	Brake	Polyurethane	3 <sup>3</sup> / <sub>4</sub> 1.5	5HHPB

## HD Super™ Dunnage Shelves — 10.67

Static load capacity (uniformly distributed)

- 48" (1219mm) shelf: 3,000 lbs. (1361kg).
- 60" (1524mm) shelf: 2,400 lbs. (1089kg).
- For use on H.D. 1<sup>5</sup>/<sub>8</sub>" (41mm) posts only.
- Removable wire deck.

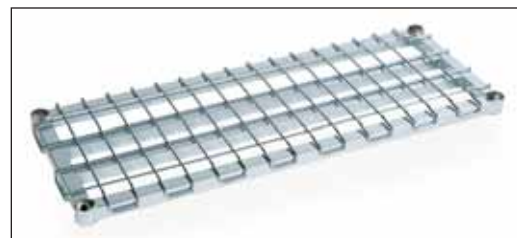

HD Super Dunnage Shelf

Width/Length (in.) (mm)		Approx. Pkd. Wt. (lbs.) (kg)		Cat. No. Chrome	Cat. No. Metroseal 3 with Microban®	Cat. No. Stainless
18x48	457x1219	35	15.7	<b>1848HDRC</b>	<b>1848HDRK3</b>	<b>1848HDRS</b>
18x60	457x1524	43	19.3	<b>1860HDRC</b>	<b>1860HDRK3</b>	<b>1860HDRS</b>
24x48	610x1219	38	17.1	<b>2448HDRC</b>	<b>2448HDRK3</b>	<b>2448HDRS</b>
24x60	610x1524	47	21.1	<b>2460HDRC</b>	<b>2460HDRK3</b>	<b>2460HDRS</b>

**Important:** In stationary shelving, stability decreases as the ratio of height to width increases and when heavier loads are placed on upper shelves. Keep units as wide and low as possible, using the dunnage shelf as the bottom shelf. If two dunnage shelves are being used, both should be placed within the lower half of the unit.

**Note:** Not compatible with Super Erecta or Super Adjustable Super Erecta components.



HD Super™ Cantilever Shelf

## HD Super™ Cantilever Shelf — 10.67

Width/Length (in.) (mm)		Approx. Pkd. Wt. (lbs.) (kg)		Cat. No. Chrome	Cat. No. Stainless
12x54	304x1372	11.8	5.3	<b>1254CHC</b>	<b>1254CHS</b>
12x60	304x1524	12.7	5.7	<b>1260CHC</b>	<b>1260CHS</b>

## HD Super™ Replacement Parts — 10.65

Replacement HD Super™ Aluminum Split Sleeves with Zinc Ring  
4 pair per bag  
Cat. No. **9986HZ**



Replacement HD Super™ Aluminum Split Sleeve

Replacement 5<sup>1</sup>/<sub>2</sub>" (140mm) Donut Bumpers  
Cat. No. **9992H**  
Above fit 1<sup>5</sup>/<sub>8</sub>" (41mm) posts only.



Replacement 5<sup>1</sup>/<sub>2</sub>" (140mm) Donut Bumper

Replacement HD Super™ Plastic Split Sleeves  
4 pair per bag  
Plastic — Cat. No. **9985H**



Replacement HD Super™ Plastic Split Sleeve

3<sup>1</sup>/<sub>2</sub>" (89mm) Foot Plates  
Cat. No. **9993HS**



3<sup>1</sup>/<sub>2</sub>" (89mm) Foot Plate

Post Clamps  
Cat. No. **9994HZ**



Post Clamp

Wall Mounting Brackets  
(not shown)  
Cat. No. **9984HZ**



Indicates antimicrobial product.

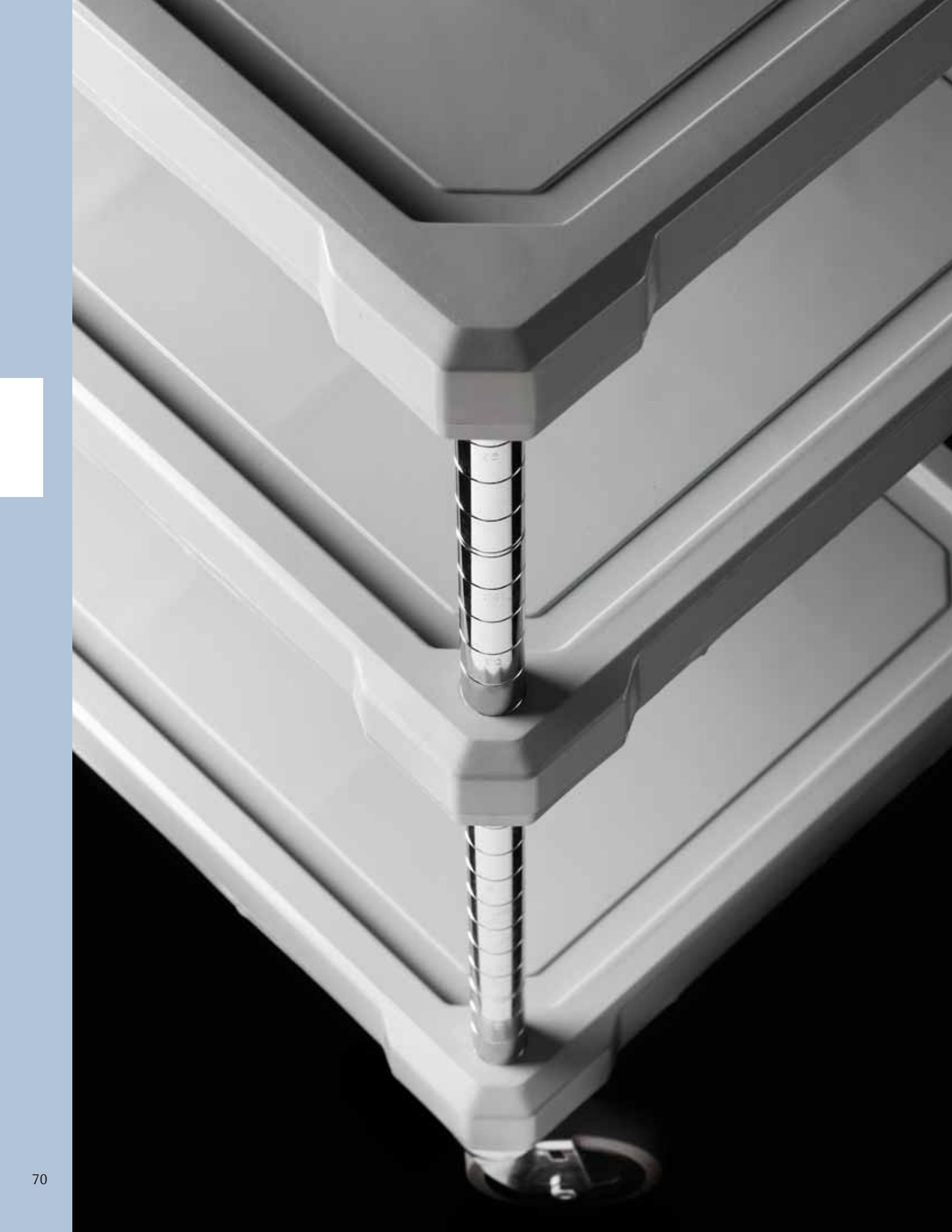

# WALL SHELVING & CARTS

Wall Shelving & Storage Systems.....72-80  
Heavy-Duty Polymer Utility Carts..... 81  
Polymer Utility Carts .....82-83  
Utility Carts.....84  
Heavy-Duty Utility Carts .....85

# Wall-to-wall efficiency.

SmartWall G3™ Productivity System  
Organized, efficient wall space at work.



A unique storage and work station system for often underutilized wall space.

**Wall-mounted tracks** are the foundation for attaching . . .

- Productivity stations with grids, accessories, and storage shelves
- Wall Shelving using uprights and Metro shelves
- Customizable storage space using combinations of shelving, grids, and specialized accessories

SmartWall G3 will keep these areas cleaner and more organized.

- Prep areas
- Janitorial supply
- Above carts that are in a staging area or a storage room
- Above sinks, work tables, casework, equipment, or bulk floor storage



**Flexible, Robust Design:** Wall tracks and uprights are designed to interface with wood studs, plywood, concrete, and other suitable wall structures.

**Easy to Adapt:** Uprights and grid brackets can be easily repositioned along the track before being fastened to the wall. Shelves and accessories are easy to add and remove.

**Easy to Install:** Once the tracks are installed level, shelving and task stations can be quickly configured.

**Easy to Clean:** Shelves, shelf supports, and grids can easily be removed for thorough cleaning of walls. Wall tracks and uprights can easily be wiped clean.

**Durable Finishes:** Super Erecta Brite for dry environments; Metroseal 3 epoxy for wet or damp environments with built-in Microban® antimicrobial product protection to inhibit the growth of bacteria, mold, mildew, and fungus that cause odors and product degradation.



**General Guidelines**

Selecting Wall Tracks.

Wall track or combination of tracks must be at least 2" (51mm) longer than the desired span of shelves. 1" (25mm) on each end of the span of tracks is reserved for hardware that acts as a stop. *(Example: If 152" (3860mm) of wall track could be mounted, then the length of a shelf tier cannot exceed 150" (3810mm).*

Uprights.

- 15" (381mm) uprights: 1 shelf tier maximum
- 30" (762mm) uprights: 3 shelf tiers maximum
- 45" (1143mm) uprights: 4 shelf tiers maximum

Shelves.

When configuring side-by-side shelving units, the adjacent shelves on the same tier must have the same depth. Minimum space between shelf tiers is 9" (229mm).

**Note:** When using MetroMax i shelves with SmartWall G3 shelf supports, order one adapter kit per shelf (Cat. No. M9997-4).

Shelf Supports.

Order to match up with the depth of the shelf.

Configuring Basic Wall Shelving



Ordering Guide

Single Shelving Unit

1. Select a wall track or tracks.
2. Select two uprights.
3. Select from Super Erecta wire or solid shelves, MetroMax Q, or MetroMax i shelves.
4. Select single shelf supports (2 per shelf)

**To order the unit pictured:**

Qty.	Cat. No.	
1	SW40BR	Wall Track
2	SWU45BR	Upright
1	2436BR	Wre Shelf
2	SWS24BR	Single Shelf Support
2	1836BR	Wire Shelf
4	SWS18BR	Single Shelf Support



Side-by-Side Shelving Unit

**To order the unit pictured:**

Qty.	Cat. No.	
1	SW56K3	Wall Track
1	SW40K3	Wall Track
4	SWU30K3	Upright
6	1830NK3	Wire Shelf
4	SWS18K3	Single Shelf Support
4	SWD18K3	Double Shelf Support



Single shelf supports are used on the ends of the wall shelf unit. Double (or Intermediate) shelf supports are used to join adjacent units.



**S**  
Single Shelf Support



**D**  
Double (Intermediate) Shelf Support

## Configuring Basic Task Stations



### General Guidelines

#### Selecting Wall Tracks

Wall track or combination of tracks must be at least 2" (51mm) longer than the desired span of shelves. 1" (25mm) on each end of the span of tracks is reserved for hardware that acts as a stop. (Example: If 152" (3860mm) of wall track could be mounted, then the length of a shelf tier cannot exceed 150" (3810mm).

#### Grids

Grids may attach directly to the uprights. Grids may not overhang the uprights by more than 6" (152mm). When uprights are not used, select the appropriate grid bracket kit based on the configuration.

#### Uprights and Shelf Supports

Enable standard Super Erecta, Super Erecta Pro, MetroMax Q, and MetroMax i shelves to be used as part of the task station.

#### Combinations of Grids and Shelves

Grids can be mounted directly behind shelves, but shelf supports and grids cannot occupy the same slots on the upright. Once the grid has been mounted to the upright, the shelf support can be mounted to its own slots and can be adjusted on 3" (76mm) increments within the grid space.



#### Consists of:

Qty.	Cat. No.	
1	SW40K3	Wall Track
2	SWU30K3	Upright
1	1836NK3	Wire Shelf
2	SWS18K3	Single Shelf Support
1	WG1836K3	Wire Grid
1	SWA1	Accessory Pack



#### Consists of:

Qty.	Cat. No.	
1	SW40K3	Wall Track
1	WG3036K3	Wire Grid
1	SWGB1	Grid Bracket Kit
1	GS1836K3	Grid Shelf
1	SWA2	Accessory Pack

## Ordering Guide

### Medium-Duty Task Station

1. Select wall track or tracks.
2. Select uprights. (two per task station)
3. Select shelves and single shelf supports. (two supports per shelf)
4. Select grid and accessories.

#### Notes:

- Most often shelves and grids of the same length are used together.
- Maximum unit capacity when mounted to wood studs or plywood is 400 lbs. (180kg).

**Note:** Refer to catalog sheet 10.42 for weight capacities in other types of wall construction.

### Standard-Duty Task Station

1. Select wall track or tracks.
2. Select grid or multiple grids.
3. Select SWGB1 grid bracket kit. (one per grid)
4. Select accessories including bulk grid shelves (pictured).

#### Notes:

- Maximum unit capacity when mounted to wood studs or plywood is 250 lbs. (113kg).

**Note:** Refer to catalog sheet 10.42 for weight capacities in other types of wall construction.

- Grids may be mounted to the wall without wall tracks using SWGB2 or WGBRKT grid bracket kits.

### Medium-Duty Task Station

**Cat. No. SWK36-1**

- Bulk overhead storage space with a 1836NK3 wire shelf
- 18" x 36" (457 x 914mm) grid space
- 40" (1016mm) track
- Overall dimensions: Length x Height  
40" x 31<sup>1</sup>/<sub>4</sub>" (1016 x 793mm)

**Consists of:**

Qty.	Cat. No.	
1	SW40K3	Wall Track
2	SWU30K3	Upright
2	SWS18K3	Single Shelf Support
1	1836NK3	Shelf
1	WG1836K3	Wire Grid



### Standard-Duty Task Station

**Cat. No. SWK36-2**

- Standard duty 50 lb. capacity overhead shelf
- 40" (1016mm) track and 30" x 36" (762 x 914mm) grid space
- Overall dimensions: Length x Height  
40" x 39<sup>11</sup>/<sub>16</sub>" (1016 x 1008mm)

**Consists of:**

Qty.	Cat. No.	
1	SW40K3	Wall Track
1	SWG1836K3	Grid Bracket Kit
1	WG3036K3	Grid
1	GS1836K3	Grid Shelf



### Accessory Pack — Sink

**Cat. No. SWA1**

- Packaged in one carton
- To fit minimum 18" x 36" (457 x 914mm) grid space
- Grids not included

**Consists of:**

Qty.	Cat. No.	
1	H210K3	Wire Basket
1	IWA-11K3	Lid Holder
1	FCH	Utensil Cylinder
1	FC1	Cylinder Holder
2	PGHK6K3	Prong Hook
6	HK23C	Standard Hook



Wire Grid and Grid Brackets Not Included.

### Accessory Pack — Prep

**Cat. No. SWA2**

- Packaged in one carton
- To fit minimum 18" x 36" (457 x 914mm) grid space
- Grids not included

**Consists of:**

Qty.	Cat. No.	
1	PBA-GSDK3	Small Shelf
2	H210K3	Wire Basket
1	DD3722A	Bin Holder
1	MB30230B	Small Bin
2	PGHK6K3	Prong Hook
6	HK23C	Standard Hook



Wire Grid and Grid Brackets Not Included.

SmartWall G3 can be configured in endless combinations of storage shelves, task station grids, and space management accessories. Visit [metro.com/SWG3](http://metro.com/SWG3) for more ideas on how to put wall space to work.



Wall Track



**Wall Tracks** (minimum one per system)

- Joiner plates and stop fastener hardware included. Does not include hardware to mount wall tracks to the wall.
- Replacement joiner plate (1) and stop fastener hardware (2 sets): Cat. No. RPTRK-HDWE

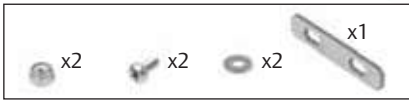

Hardware

Actual Length (in.)	Actual Length (mm)	Actual Depth (in.)	Actual Depth (mm)	Actual Width (in.)	Actual Width (mm)	Approx. Pkd. Wt. (lbs.)	Approx. Pkd. Wt. (kg)	Cat. No. Super Erecta Brite	Cat. No. Metroseal 3
40	1016	3/4	19	1 9/16	40	5.0	2.2	SW40BR	SW40K3
56	1423	3/4	19	1 9/16	40	6.0	2.6	SW56BR	SW56K3
72	1829	3/4	19	1 9/16	40	7.0	3.1	SW72BR	SW72K3

\*Note: Tracks can be cut to length, but Metro does not provide this service. Touch-up paint for Metroseal 3 tracks is available. Cat. No. TP-K2.

**Uprights** (For medium-duty applications, minimum two per system. Sold by the piece)

- Built-in slots allow shelf supports and grids to attach without tools or hardware.
- 1 1/2" (38mm) slot spacing allows shelves and grids to be adjusted on 1/2" (38mm) increments

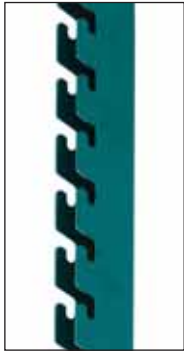

Actual Length (in.)	Actual Length (mm)	Actual Width (in.)	Actual Width (mm)	Actual Depth (in.)	Actual Depth (mm)	Number of Slots	Approx. Pkd. Wt. (lbs.)	Approx. Pkd. Wt. (kg)	Cat. No. Super Erecta Brite	Cat. No. Metroseal 3
16	406	1 1/8	29	1 7/8	48	7	1.8	0.8	SWU15BR	SWU15K3
31	787	1 1/8	29	1 7/8	48	17	3.5	1.5	SWU30BR	SWU30K3
44 1/2	1130	1 1/8	29	1 7/8	48	26	5.3	2.3	SWU45BR	SWU45K3

**Shelf Supports** (Sold by the piece)

- Mount directly to slotted uprights. Suitable for use with Super Erecta, MetroMax Q, and MetroMax i shelves.
- Single shelf supports are used on each end of a single unit or side-by-side unit.
- Double (intermediate) shelf supports are used when configuring side-by-side wall shelving units.

**Single Shelf Supports**

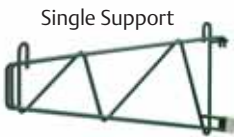

Single Support

Fits shelf depth	Actual Length (in.)	Actual Length (mm)	Actual Width (in.)	Actual Width (mm)	Actual Height (in.)	Actual Height (mm)	Approx. Pkd. Wt. (lbs.)	Approx. Pkd. Wt. (kg)	Cat. No. Super Erecta Brite	Cat. No. Metroseal 3
14" (355mm)	16 9/16	421	1 1/2	38	8 3/16	208	2.5	1.1	SWS14BR	SWS14K3
18" (457mm)	20 9/16	522	1 1/2	38	8 3/16	208	3.0	1.3	SWS18BR	SWS18K3
21" (530mm)	23 9/16	598	1 1/2	38	8 3/16	208	3.5	1.5	SWS21BR	SWS21K3
24" (610mm)	26 9/16	675	1 1/2	38	8 3/16	208	3.5	1.5	SWS24BR	SWS24K3

\*Note: Replacement plastic sleeve for shelf support. Cat. No. RP-SPSLV.

Note: When using MetroMax i shelves with shelf supports, please order 1 adapter kit per shelf. Cat. No. M9997-4

**Double (Intermediate) Shelf Supports**

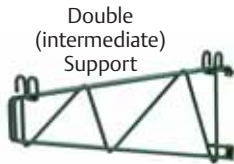

Double (intermediate) Support

Fits shelf depth	Actual Length (in.)	Actual Length (mm)	Actual Width (in.)	Actual Width (mm)	Actual Height (in.)	Actual Height (mm)	Approx. Pkd. Wt. (lbs.)	Approx. Pkd. Wt. (kg)	Cat. No. Super Erecta Brite	Cat. No. Metroseal 3
14" (355mm)	16 9/16	421	1 1/2	38	8 3/16	208	2.5	1.1	SWD14BR	SWD14K3
18" (457mm)	20 9/16	522	1 1/2	38	8 3/16	208	3.0	1.3	SWD18BR	SWD18K3
21" (530mm)	23 9/16	598	1 1/2	38	8 3/16	208	3.5	1.5	SWD21BR	SWD21K3
24" (610mm)	26 9/16	675	1 1/2	38	8 3/16	208	3.5	1.5	SWD24BR	SWD24K3

\*Note: Replacement plastic sleeve for shelf support. Cat. No. RP-SPSLV.

Note: When using MetroMax i shelves with shelf supports, please order 1 adapter kit per shelf. Cat. No. M9997-4



SWGB1

x4



SWGB2

WGBRKT

x6

x6

**Grid Mounting Brackets** (for standard-duty applications without uprights)

- Use to connect the grid to the wall when uprights are not used. One kit required per grid.

Description	Approx. Pkd. Wt. (lbs.)	Approx. Pkd. Wt. (kg)	Cat. No.
Bracket kit to connect grid to wall track; includes (2) top and (4) bottom (stainless steel)	2.0	0.9	SWGB1
Direct wall mount bracket kit; consists of (6) bottom brackets (stainless steel)	2.0	0.9	SWGB2
Direct wall mount bracket kit; consists of (6) black plastic brackets	2.0	0.9	WGBRKT

**Wire Grids**

- Brackets to mount the grid to the wall track or the wall are not included and can attach directly to uprights without brackets or tools.
- Grid openings measure approximately 3" x 3" (76 x 76mm)



Grid: 18" x 36" (457 x 914mm)

Width x Length (in.)	Width x Length (mm)	Approx. Pkd. Wt. (lbs.)	Approx. Pkd. Wt. (kg)	Cat. No. Plated	Cat. No. Metroseal 3
18x30	457x760	7.5	3.3	—	WG1830K3
18x36	457x914	9.0	4.1	WG1836BR	WG1836K3
18x48	457x1219	12.0	5.4	WG1848BR	WG1848K3
18x60	457x1524	14.0	6.4	WG1860BR	WG1860K3
24x36	610x914	12.0	5.4	—	WG2436K3
24x48	610x1219	15.5	7.0	—	WG2448K3
30x36	760x914	12.8	5.8	—	WG3036K3
30x48	760x1219	16.5	7.5	—	WG3048K3
33x54	838x1370	21.0	9.5	PBA-GPC	—

\*Note: Can be retrofitted to original MetroMax and MetroMax Q shelving.

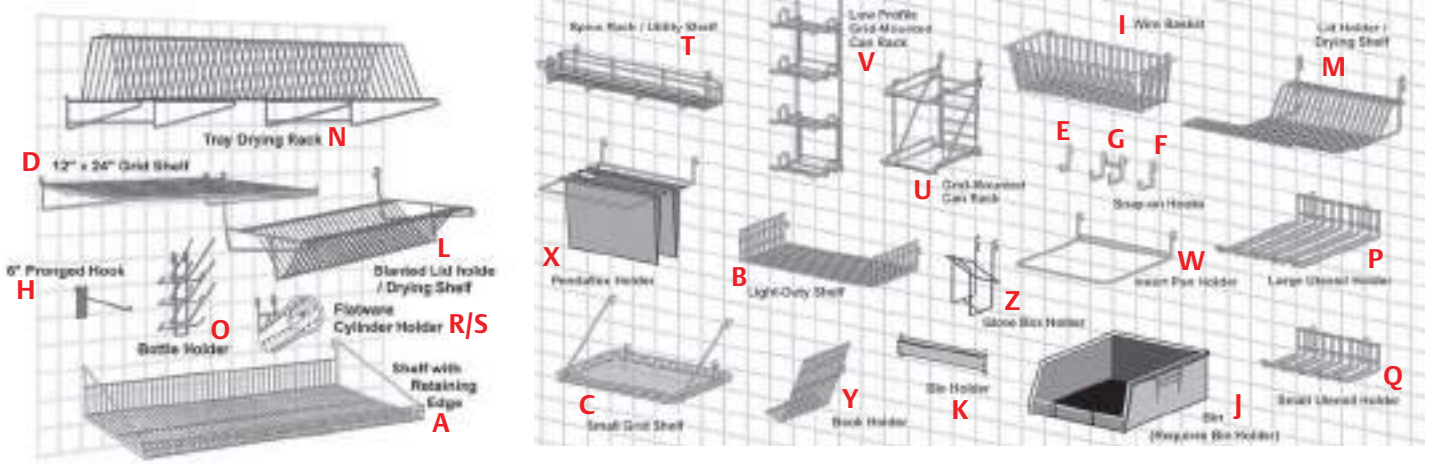

### Shelves for Grids

		Width/Length/Height (in.) (mm)		Approx. Pkd. Wt. (lbs.) (kg)	Cat. No. Plated	Cat. No. Metroseal 3
<b>A</b>	14"x36" (356x914mm) Shelf w/Retaining Edge	15 <sup>9</sup> / <sub>8</sub> x35 <sup>1</sup> / <sub>4</sub> x7 <sup>3</sup> / <sub>4</sub>	391x895x197	12 4.5	—	<b>GS1436K3</b>
<b>A</b>	14"x48" (356x1219mm) Shelf w/Retaining Edge	15 <sup>9</sup> / <sub>8</sub> x47 <sup>1</sup> / <sub>4</sub> x7 <sup>3</sup> / <sub>4</sub>	391x1200x197	16 6.0	—	<b>GS1448K3</b>
<b>A</b>	18"x30" (457x762mm) Shelf w/Retaining Edge	19 <sup>9</sup> / <sub>8</sub> x29 <sup>1</sup> / <sub>4</sub> x7 <sup>3</sup> / <sub>4</sub>	492x743x197	15 5.6	—	<b>GS1830K3</b>
<b>A</b>	18"x36" (457x914mm) Shelf w/Retaining Edge	19 <sup>9</sup> / <sub>8</sub> x35 <sup>1</sup> / <sub>4</sub> x7 <sup>3</sup> / <sub>4</sub>	492x895x197	18 6.7	—	<b>GS1836K3</b>
<b>A</b>	18"x48" (457x1219mm) Shelf w/Retaining Edge	19 <sup>9</sup> / <sub>8</sub> x47 <sup>1</sup> / <sub>4</sub> x7 <sup>3</sup> / <sub>4</sub>	492x1200x197	24 9.0	—	<b>GS1848K3</b>
<b>B</b>	Light-Duty Shelf with Side Ledges	9 W.x18 <sup>1</sup> / <sub>2</sub> L.	228 W.x470 L.	4 1.8	<b>PBA-GSD</b>	<b>PBA-GSDK3</b>
<b>C</b>	Small Grid Shelf — 18" (457mm)	16 <sup>3</sup> / <sub>4</sub> W.x16 <sup>3</sup> / <sub>4</sub> L.	425 W.x425 L.	6 2.7	<b>PBA-MS</b>	<b>PBA-MSK3</b>
<b>D</b>	Flat Grid Shelf — 24" (610mm)	12 <sup>1</sup> / <sub>16</sub> x24x4	322x610x102	7 2.6	—	<b>FGS1224K3</b>

### Hooks

		Width/Length/Height (in.) (mm)		Approx. Pkd. Wt. (lbs.) (kg)	Cat. No. Chrome	Cat. No. Metroseal
<b>E</b>	Small Hook	1 <sup>1</sup> / <sub>4</sub> x3 <sup>1</sup> / <sub>2</sub>	32x89	—	<b>HK23C</b>	—
<b>F</b>	Large Hook	2x3 <sup>1</sup> / <sub>2</sub>	50x89	—	<b>HK25C</b>	—
<b>G</b>	Double Large Hook	2x3 <sup>1</sup> / <sub>2</sub>	50x89	—	<b>HK26C</b>	—
<b>H</b>	6" (152mm) Pronged Hook	1 <sup>1</sup> / <sub>4</sub> x7 <sup>5</sup> / <sub>8</sub> x5 <sup>5</sup> / <sub>8</sub>	32x194x92	.3 0.1	—	<b>PGHK6K3</b>

### Baskets

		Width/Length/Height (in.) (mm)		Approx. Pkd. Wt. (lbs.) (kg)	Cat. No. Chrome	Cat. No. Metroseal 3
<b>I</b>	Small Basket	13 <sup>3</sup> / <sub>8</sub> x5x7	345x127x180	8.5 4	<b>H209C</b>	<b>H209K3</b>
<b>I</b>	5" (127mm) Deep Large Basket	17 <sup>3</sup> / <sub>8</sub> x7 <sup>1</sup> / <sub>2</sub> x5	440x190x127	7 3	<b>H210C</b>	<b>H210K3</b>
<b>I</b>	10" (254mm) Deep Large Basket	17 <sup>3</sup> / <sub>8</sub> x7 <sup>1</sup> / <sub>2</sub> x10	440x190x255	11 5	<b>H212C</b>	<b>H212K3</b>

### Bins and Holders

		Width/Length/Height (in.) (mm)		Approx. Pkd. Wt. (lbs.) (kg)	Cat. No.
<b>J</b>	Blue Bin Packed 12/Ctn.	10 <sup>7</sup> / <sub>8</sub> x5 <sup>1</sup> / <sub>2</sub> x5	279x140x127	1 0.45	<b>MB30230B</b>
<b>J</b>	Blue Bin Packed 6/Ctn.	10 <sup>7</sup> / <sub>8</sub> x11x5	279x280x127	1.5 0.68	<b>MB30235B</b>
<b>J</b>	Blue Bin Packed 12/Ctn.	14 <sup>3</sup> / <sub>4</sub> x8 <sup>1</sup> / <sub>4</sub> x7	375x210x180	2 0.91	<b>MB30240B</b>
<b>K</b>	Single Bin Holder	3x <sup>1</sup> / <sub>2</sub> (LxH)	76x13 (LxH)	0.5 0.23	<b>DD3722A</b>
<b>K</b>	Small Bin Holder	11x3 (LxH)	280x76 (LxH)	1 .45	<b>PBA-1BH</b>
<b>K</b>	Large Bin Holder	22x3	559x76 (LxH)	2 .91	<b>PBA-2BH</b>

### Drying Rack Accessories

		Width/Length/Height (in.) (mm)		Pkd. Wt. (lbs.) (kg)	Cat. No. Plated	Cat. No. Metroseal 3
<b>L</b>	Slanted Lid Holder/Drying Shelf	14 <sup>1</sup> / <sub>8</sub> x20 <sup>3</sup> / <sub>4</sub> x12 <sup>1</sup> / <sub>8</sub>	359x527x307	5.0 2.3	—	<b>IWA-S11K3</b>
<b>M</b>	Lid Holder/Drying Shelf	8 <sup>1</sup> / <sub>4</sub> x13 <sup>1</sup> / <sub>2</sub> x4 <sup>1</sup> / <sub>2</sub>	210x343x114	2 0.9	—	<b>IWA-11K3</b>
<b>N</b>	Tray Drying Rack	14 <sup>9</sup> / <sub>16</sub> x46 <sup>1</sup> / <sub>4</sub> x10 <sup>9</sup> / <sub>16</sub>	371x1175x259	12.0 5.4	—	<b>TDR48K3</b>
<b>O</b>	6-Prong Bottle Holder	14 <sup>7</sup> / <sub>8</sub> x5 <sup>1</sup> / <sub>8</sub> x11	378x130x279	2.3 0.8	—	<b>BH6K3</b>

### Utensil Holders

		Width/Length/Height (in.) (mm)		Approx. Pkd. Wt. (lbs.) (kg)	Cat. No. Plated	Cat. No. Metroseal 3
<b>P</b>	Large Utensil Holder	10 <sup>1</sup> / <sub>2</sub> x10 <sup>3</sup> / <sub>8</sub> x4	267x264x102	4 1.8	—	<b>IWA-12K3</b>
<b>Q</b>	Small Utensil Holder	4 <sup>3</sup> / <sub>8</sub> x10 <sup>3</sup> / <sub>8</sub> x4	111x264x102	4 1.8	—	<b>IWA-14K3</b>
<b>R</b>	Flatware/Instrument Cylinder	4 <sup>5</sup> / <sub>16</sub> x4 <sup>5</sup> / <sub>16</sub> x5 <sup>1</sup> / <sub>2</sub>	109x109x140	0.3 0.1	—	<b>FC1</b>
<b>S</b>	Cylinder Holder	2 <sup>5</sup> / <sub>8</sub> x5 <sup>7</sup> / <sub>8</sub> x5 <sup>3</sup> / <sub>4</sub>	67x149x146	1.0 0.5	—	<b>FCH</b>

### Miscellaneous Accessories

		Width/Length/Height (in.) (mm)		Approx. Pkd. Wt. (lbs.) (kg)	Cat. No. Plated	Cat. No. Metroseal 3
<b>T</b>	Spice Rack/Utility Shelf	5 <sup>1</sup> / <sub>4</sub> x22 <sup>1</sup> / <sub>2</sub> x4	133x571x102	3.5 1.6	<b>SR24BR</b>	<b>SR24K3</b>
<b>U</b>	Grid Mounted Can Rack, 4 Capacity	8 <sup>1</sup> / <sub>4</sub> x13 <sup>3</sup> / <sub>4</sub> x12	210x349x305	4 1.8	<b>CR4BR</b>	—
<b>V</b>	Low-Profile Can Rack, 4 Capacity	6 <sup>1</sup> / <sub>2</sub> x7 <sup>3</sup> / <sub>4</sub> x28 <sup>1</sup> / <sub>2</sub>	165x197x724	4.3 2.0	<b>CR4LPBR</b>	—
<b>W</b>	Insert Pan Holder	7 <sup>1</sup> / <sub>2</sub> x12 <sup>1</sup> / <sub>2</sub> x4	190x317x102	2.3 1.0	<b>STP3BR</b>	—
<b>X</b>	Hanging File Holder	6 <sup>1</sup> / <sub>4</sub> W.x12 <sup>1</sup> / <sub>2</sub> L.	159 W.x317 L.	3 1.4	<b>PBA-PFH</b>	—
<b>Y</b>	Book Holder	2 W. x 9 H.	50 W.x228 H.	3 1.4	<b>PBA-CHD</b>	—
<b>Z</b>	Glove Box Holder (Vertical)	6 <sup>3</sup> / <sub>8</sub> W.x10 <sup>1</sup> / <sub>2</sub> H. Inside Dimensions 5 <sup>7</sup> / <sub>8</sub> " W.x3 <sup>7</sup> / <sub>16</sub> " D. [267mm W.x87mm D.]	162 W.x267H.	2 0.9	—	<b>GBHVK3</b>



**Erecta Shelf® Wall Mounts — 10.56**

Used to create wall-mounted shelving units with 12" (305mm) or 18" (457mm) Erecta shelves of any length.

- Models are available to accommodate from one to five shelves. (Each mount consists of two shelf supports and mounting brackets.)
- Wall bolts or screws not included; they must be selected according to type of wall.
- Order shelves from page 67.



Wall Mounts with Shelf  
(Shelf sold separately, see page 39)

Width (in.)	Width (mm)	Height (in.)	Height (mm)	Capacity	Approx. Pkd. Wt. (Pr.)		Cat. No. Chrome
					(lbs.)	(kg)	
12	305	10 <sup>3</sup> / <sub>4</sub>	273	1 Shelf	2 <sup>1</sup> / <sub>2</sub>	1.1	<b>12WB1C</b>
12	305	20 <sup>13</sup> / <sub>16</sub>	528	1 to 3 Shelves	5	2.3	<b>12WB3C</b>
12	305	30 <sup>13</sup> / <sub>16</sub>	782	1 to 5 Shelves	7 <sup>1</sup> / <sub>4</sub>	3.2	<b>12WB5C</b>
18	457	11 <sup>3</sup> / <sub>4</sub>	298	1 Shelf	3	1.4	<b>18WB1C</b>
18	457	21 <sup>5</sup> / <sub>8</sub>	548	1 to 3 Shelves	6	2.7	<b>18WB3C</b>
18	457	31 <sup>5</sup> / <sub>8</sub>	807	1 to 5 Shelves	8 <sup>1</sup> / <sub>2</sub>	3.8	<b>18WB5C</b>

For additional mounting brackets (single) order Cat. No. **9975C**

Double mounting brackets are also available for use where continuous wall shelving is to be installed. Cat. No. **9976C**

Load Rating: 200 lbs. (91kg) per shelf, not to exceed 200 lbs. (91kg) per unit.

Units must be secured to sufficient wall support structure.



12WS12C  
Erecta Shelf® Wall Kit

**Erecta Shelf® Wall Kit — 10.56**

Kit includes two shelves, shelf supports, and mounting brackets. Wall bolts and screws not included; they must be selected according to type of wall. Chrome.

Shelf Length (in.)	Shelf Length (mm)	Overall Length (in.)	Overall Length (mm)	Shelf Width (in.)	Shelf Width (mm)	Overall Width (in.)	Overall Width (mm)	Overall Height (in.)	Overall Height (mm)	Approx. Pkd. Wt. (lbs.)	Approx. Pkd. Wt. (kg)	Cat. No.
24	610	26 <sup>1</sup> / <sub>4</sub>	673	12	305	13	330	21	530	18 <sup>1</sup> / <sub>2</sub>	8.3	<b>12WS12C</b>
36	914	38 <sup>1</sup> / <sub>4</sub>	971	12	305	13	330	21	530	25 <sup>1</sup> / <sub>4</sub>	11.3	<b>12WS32C</b>
48	1219	50 <sup>1</sup> / <sub>4</sub>	1283	12	305	13	330	21	530	32	14.4	<b>12WS52C</b>

Kit packaged in one box and UPS shippable.

Load Rating: 200 lbs. (91kg) per shelf, not to exceed 200 lbs. (91kg) per unit.

Units must be secured to sufficient wall support structure.

**Direct Wall Mount Shelving — 9.20**

Use standard Super Erecta stainless steel direct wall mount shelf supports with MetroMax shelves or open frames with wire drop in baskets. Order one MetroMax corner adapter kit with each shelf or shelf frame. Shelf supports are sold individually.

Single — Use at shelf ends; two are required for a stand-alone shelf.



Wall Mount Brackets shown with MetroMax i  
Open Frame and Drop-In Basket.

Shelf Width (in.)	Shelf Width (mm)	Approx. Pkd. Wt.		Cat. No. Stainless Steel
		(lbs.)	(kg)	
18	457	2	0.9	<b>1WD18S</b>
24	610	2 <sup>1</sup> / <sub>4</sub>	1.0	<b>1WD24S</b>

Double — When constructing a run of shelves, use double shelf supports to join adjacent shelves.

Shelf Width (in.)	Shelf Width (mm)	Approx. Pkd. Wt.		Cat. No. Stainless Steel
		(lbs.)	(kg)	
18	457	3	1.4	<b>2WD18S</b>
24	610	4 <sup>1</sup> / <sub>4</sub>	2.0	<b>2WD24S</b>

For MetroMax i Open Frame and Drop-In Basket, see page 27.

**MetroMax i® Corner Adapter Kit**

Order one kit per MetroMax i shelf or shelf frame.

Cat. No. **M9997-4**

**Wall Mounts**

An ideal method for storing items overhead or above work surfaces.

- Brackets accommodate all Super Erecta® sizes and types of shelves.
- Use double supports to mount adjacent shelves, single supports at ends.
- Metal caps to cover openings are provided.
- Available in chrome, Metroseal 3 or stainless steel.

**Post-Type Wall Mounts — 10.40**

**Standard Units**

Post-type wall mounts are available in pre-packaged “End Units” and “Mid Units; complete with all needed components except shelves, wall bolts or screws, which must be selected according to type of wall. \*Shelf supports are chrome-plated.

- A** “End Unit” consists of two posts with wall mounting brackets, and two single shelf supports for each shelf level.
- B** “Mid Unit” consists of one post with brackets and double support for each shelf.

If shelving is to be the length of one shelf, order End Unit only.

If two-shelf lengths, order one End Unit and one Mid Unit; three lengths, one End and two Mid Units; four lengths, one End and three Mid Units; etc.

**For 14" (355mm) Shelf Width**

Shelf Levels	Approx. Pkd. Wt.		Cat. No. End Unit	Approx. Pkd. Wt.		Cat. No. Mid Unit
	(lbs.)	(kg)		(lbs.)	(kg)	
1	7	3.2	<b>SW21C</b>	5	2.3	<b>AW21C</b>
2	14	6.4	<b>SW23C</b>	9	4.1	<b>AW23C</b>
3	22	10	<b>SW25C</b>	14	6.4	<b>AW25C</b>
4	28	12.7	<b>SW26C</b>	18	8.2	<b>AW26C</b>

**For 18" (457mm) Shelf Width**

Shelf Levels	Approx. Pkd. Wt.		Cat. No. End Unit	Approx. Pkd. Wt.		Cat. No. Mid Unit
	(lbs.)	(kg)		(lbs.)	(kg)	
1	7	3.2	<b>SW31C</b>	5	2.3	<b>AW31C</b>
2	14	6.4	<b>SW33C</b>	11	5	<b>AW33C</b>
3	22	10	<b>SW35C</b>	17	8	<b>AW35C</b>
4	28	12.7	<b>SW36C</b>	21	9.5	<b>AW36C</b>

**For 21" (530mm) Shelf Width**

Shelf Levels	Approx. Pkd. Wt.		Cat. No. End Unit	Approx. Pkd. Wt.		Cat. No. Mid Unit
	(lbs.)	(kg)		(lbs.)	(kg)	
1	8	3.6	<b>SW41C</b>	6	2.7	<b>AW41C</b>
2	16	7.3	<b>SW43C</b>	12	5.5	<b>AW43C</b>
3	25	11.3	<b>SW45C</b>	18	8.2	<b>AW45C</b>
4	32	14.4	<b>SW46C</b>	23	10.4	<b>AW46C</b>

**For 24" (610mm) Shelf Width**

Shelf Levels	Approx. Pkd. Wt.		Cat. No. End Unit	Approx. Pkd. Wt.		Cat. No. Mid Unit
	(lbs.)	(kg)		(lbs.)	(kg)	
1	9	4.1	<b>SW51C</b>	6	2.7	<b>AW51C</b>
2	18	8.2	<b>SW53C</b>	12	5.5	<b>AW53C</b>
3	28	12.7	<b>SW55C</b>	19	9	<b>AW55C</b>
4	36	16	<b>SW56C</b>	24	10.9	<b>AW56C</b>

\*Note: User should determine that wall material and method of mounting are suitable to support the shelves and their contents. Mounting hardware not included.

Maximum Load Rating: 250 lbs. (113kg) per shelf, not to exceed 250 lbs. (113kg) per unit.

See page 42 for Super Erecta shelves.



Post-Type Wall Mount Installation



Post-Type Wall Mounts

**Metro Tip:**

Have you looked at your walls lately?

Unused wall space provides the perfect opportunity for a significant increase in storage capacity. Metro offers a complete line of wall shelving systems to maximize storage density.

Posts and Brackets — 10.40

Two end brackets (BES) are supplied with each of these double-footed posts. One intermediate bracket (BCS) is supplied with 33PDF posts and two are supplied with 54PDF and 63PDF posts. Order desired number/style of shelf supports below.

Post Height (in.) (mm)	Description	Approx. Pkd. Wt. (lbs.) (kg)	Cat. No. Chrome	Cat. No. Metroseal 3 with Microban®	Cat. No. Stainless
13 <sup>7</sup> / <sub>8</sub> 350	Post for 1 tier	1 <sup>1</sup> / <sub>4</sub> 0.6	13PDF	13PDFK3	13PDFS
33 <sup>5</sup> / <sub>8</sub> 854	Post for 2 tiers	2 <sup>3</sup> / <sub>4</sub> 1.2	33PDF	33PDFK3	33PDFS
54 1370	Post for 3 or more tiers	5 2.3	54PDF	54PDFK3	54PDFS
62 1573	Post for 4 or more tiers	6 2.7	63PDF	63PDFK3	63PDFS
	End Bracket	1 <sup>1</sup> / <sub>2</sub> 0.2	BES	BESK3	SBES
	Intermediate Bracket	1 <sup>1</sup> / <sub>2</sub> 0.2	BCS	BCSK3	SBCS

**Note:** User should determine that wall material and method of mounting are suitable to support the shelves and their contents. Mounting hardware not included. Order shelves from page 42.

Corner Adapters for MetroMax i shelving

Use when joining MetroMax i shelves with wire shelf supports. Box of 4. Use one box per shelf. Cat. No. **M9997-4** per box of 4

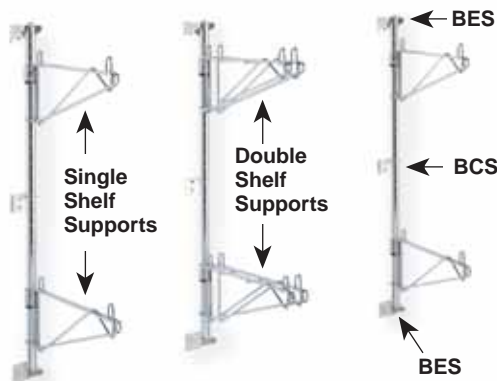

Typical configuration using two end units and one mid unit

Maximum Load Rating: 250 lbs. (113kg) per shelf, not to exceed 250 lbs. (113kg) per unit.

See page 42 for Super Erecta shelves.

**Metro Tip:** MetroMax Q and MetroMax i shelves can be used with Super Erecta Post Mounting Shelf Supports and Direct Wall Mounts.

Shelf Supports — Post Mounting — 10.40

Single — Two required per shelf (one at each end.)

Shelf Width (in.) (mm)	Approx. Pkd. Wt. (lbs.) (kg)	Cat. No. Chrome	Cat. No. Metroseal 3 with Microban®	Cat. No. Stainless
14 355	2 0.9	1WS14C	1WS14K3	1WS14S
18 457	2 0.9	1WS18C	1WS18K3	1WS18S
21 530	2 <sup>1</sup> / <sub>2</sub> 1.1	1WS21C	1WS21K3	1WS21S
24 610	3 1.4	1WS24C	1WS24K3	1WS24S

Double — For run of multiple shelves.

Shelf Width (in.) (mm)	Approx. Pkd. Wt. (lbs.) (kg)	Cat. No. Chrome	Cat. No. Metroseal 3 with Microban®	Cat. No. Stainless
14 355	3 1.4	2WS14C	2WS14K3	2WS14S
18 457	3 <sup>3</sup> / <sub>4</sub> 1.7	2WS18C	2WS18K3	2WS18S
21 530	4 <sup>1</sup> / <sub>4</sub> 1.9	2WS21C	2WS21K3	2WS21S
24 610	4 <sup>1</sup> / <sub>2</sub> 2.0	2WS24C	2WS24K3	2WS24S

Order shelves from page 42.

Direct Wall Mounts — 10.40

Each consists of one shelf support and mounting plate, with two shelf collar caps. Use single support at shelf ends; double support for adjoining shelves.

Single — Two required per shelf.

Shelf Width (in.) (mm)	Approx. Pkd. Wt. (lbs.) (kg)	Cat. No. Chrome	Cat. No. Metroseal 3 with Microban®	Cat. No. Stainless
14 355	1 <sup>1</sup> / <sub>2</sub> 0.7	1WD14C	1WD14K3	1WD14S
18 457	2 0.9	1WD18C	1WD18K3	1WD18S
21 530	2 0.9	1WD21C	1WD21K3	1WD21S
24 610	2 <sup>1</sup> / <sub>4</sub> 1.0	1WD24C	1WD24K3	1WD24S

Double

Shelf Width (in.) (mm)	Approx. Pkd. Wt. (lbs.) (kg)	Cat. No. Chrome	Cat. No. Metroseal 3 with Microban®	Cat. No. Stainless
14 355	3 1.4	2WD14C	2WD14K3	2WD14S
18 457	3 1.4	2WD18C	2WD18K3	2WD18S
21 530	4 1.8	2WD21C	2WD21K3	2WD21S
24 610	4 <sup>1</sup> / <sub>2</sub> 2.0	2WD24C	2WD24K3	2WD24S

**Note:** User should determine that wall material and method of mounting are suitable to support the shelves and their contents.



Single Shelf Support



Double Shelf Support



Hole Plugs — 10.06

This chrome-plated cover is used to fill shelf-corner openings. Use wherever posts have been eliminated by "S" hooks.

Cat. No. **9997C**

✓ Indicates antimicrobial product.



# Push ahead.

Give yourself the versatility you need with Metro Utility Carts.

## Utility Carts

- Can be used in a variety of unique transport applications.
- Durable materials, ergonomic handles, and premium casters promote long life and ease of use.
- Microban product protection built into the shelf mats, frames, and posts.
- Easier to clean with removable shelf mats.

## MetroMax i® Utility Carts

- Corrosion proof shelves, posts, and Type 304 stainless steel handle.
- Corrosion resistant 5PCX casters with 5" (127mm) polyurethane wheels, polymer horns, and stainless steel axles.
- 39 1/4" (997mm) tall. Weight capacity of cart: 900 lbs. (408kg) evenly distributed.

Nominal Width/Length (in.)	Nominal Width/Length (mm)	Actual Width/Length (in.)	Actual Width/Length (mm)	Description	Approx. Pkd. Wt. (lbs.)	Approx. Pkd. Wt. (kg)	Cat. No.
18x30	457x760	20 5/16 x 34 1/2	516 x 876	2-shelf	35.5	15.8	<b>MXUC1830G-25</b>
24x36	610x914	26 5/16 x 40 1/2	668 x 1029	2-shelf	46.0	20.5	<b>MXUC2436G-25</b>
18x30	457x760	20 5/16 x 34 1/2	516 x 876	3-shelf	46.0	20.5	<b>MXUC1830G-35</b>
24x36	610x914	26 5/16 x 40 1/2	668 x 1029	3-shelf	61.5	27.5	<b>MXUC2436G-35</b>



## MetroMax Q® Utility Carts

- Quick adjust corrosion resistant shelves and posts.
- Corrosion proof Type 304 stainless steel handle.
- Includes four 5MPX casters with 5" (127mm) polyurethane wheels.
- 39 1/4" (997mm) tall. Weight capacity of cart: 900 lbs. (408kg) evenly distributed.

Nominal Width/Length (in.)	Nominal Width/Length (mm)	Actual Width/Length (in.)	Actual Width/Length (mm)	Description	Approx. Pkd. Wt. (lbs.)	Approx. Pkd. Wt. (kg)	Cat. No.
18x30	457x760	20 5/16 x 34 1/2	16 x 876	2-shelf	35.5	15.8	<b>MQUC1830G-25</b>
24x36	610x914	26 5/16 x 40 1/2	668 x 1029	2-shelf	46.0	20.5	<b>MQUC2436G-25</b>
18x30	457x760	20 5/16 x 34 1/2	516 x 876	3-shelf	46.0	20.5	<b>MQUC1830G-35</b>
24x36	610x914	26 5/16 x 40 1/2	668 x 1029	3-shelf	61.5	27.5	<b>MQUC2436G-35</b>



## Helpful Hints

- Configure a cart to your exact needs using a combination of MetroMax i® and Q™ shelves and posts.
- Consider MetroMax i solid shelves when spill containment is required or to protect supplies from dirt during transport.
- A typical utility cart will be configured using 27" (685mm) or 33" (875mm) stem caster posts with 5" (127mm) casters.

Shelves and posts: pages 14-15 Casters: page 16 Handles: page 17



Solid bottom shelf and 5PCX/5PCBX casters pictured



Gray (G)



Blue (BU)



Slate Blue with  
Microban Antimicrobial (MB)



Black (BL)

Weight Load Capacity:  
150 lbs. (68kg) per shelf.  
400 lbs. (181kg) per unit.

**BC Series Utility Carts — 12.28**

- Metro BC carts are available in aesthetic colors: Gray, Blue, Black and Slate Blue.
- Shelves specially designed to resist staining and wipe clean easily. Shelves with Microban® antimicrobial helps keep shelves “cleaner between cleanings” by inhibiting the growth of bacteria, mold, and mildew that cause odors, stains and product degradation. Slate blue color.
- 7/16" (11mm) deep ship’s edge lip around shelf perimeter contains spills.
- Available in 2-shelf and 3-shelf styles.



Width/Length/Height (in.) (mm)		Description	Approx. Pkd. Wt. (lbs.) (kg)		Cat. No.*
18x28x33 <sup>1</sup> / <sub>4</sub>	457x710x845	2-shelf unit	27 <sup>1</sup> / <sub>2</sub>	12.4	<b>BC1627-24</b>
18x28x33 <sup>1</sup> / <sub>4</sub>	457x710x845	3-shelf unit	33	14.9	<b>BC1627-34</b>
21 <sup>1</sup> / <sub>2</sub> x33 <sup>3</sup> / <sub>4</sub> x33 <sup>1</sup> / <sub>4</sub>	546x857x845	2-shelf unit	34 <sup>1</sup> / <sub>2</sub>	15.6	<b>BC2030-24</b>
21 <sup>1</sup> / <sub>2</sub> x33 <sup>3</sup> / <sub>4</sub> x33 <sup>1</sup> / <sub>4</sub>	546x857x845	3-shelf unit	43	19.5	<b>BC2030-34</b>
27x39 <sup>1</sup> / <sub>2</sub> x33 <sup>1</sup> / <sub>4</sub>	686x1003x845	2-shelf unit	40 <sup>1</sup> / <sub>2</sub>	18.3	<b>BC2636-24</b>
27x39 <sup>1</sup> / <sub>2</sub> x33 <sup>1</sup> / <sub>3</sub>	686x1003x845	3-shelf unit	52	23.5	<b>BC2636-34</b>
18x28x33 <sup>1</sup> / <sub>4</sub>	457x711x845	Antimicrobial 2-shelf unit	27 <sup>1</sup> / <sub>2</sub>	12.4	<b>BC1627-24MB</b>
18x28x33 <sup>1</sup> / <sub>4</sub>	457x711x845	Antimicrobial 3-shelf unit	33	14.9	<b>BC1627-34MB</b>
21 <sup>1</sup> / <sub>2</sub> x33 <sup>3</sup> / <sub>4</sub> x33 <sup>1</sup> / <sub>4</sub>	546x857x845	Antimicrobial 2-shelf unit	34 <sup>1</sup> / <sub>2</sub>	15.6	<b>BC2030-24MB</b>
21 <sup>1</sup> / <sub>2</sub> x33 <sup>3</sup> / <sub>4</sub> x33 <sup>1</sup> / <sub>4</sub>	546x857x845	Antimicrobial 3-shelf unit	43	19.5	<b>BC2030-34MB</b>

Cart is available in 2-shelf and 3-shelf. \*Colors available are: Gray (G), Blue (BU), and Black (BL).  
\*Add color designation to part number when specifying, i.e.: BC1627-34G = Three-shelf Gray unit.

**Utility Cart Accessories — 12.28**

Baskets and Bins for Two- and Three-Shelf 16"x27" (406x685mm) and 20"x30" (508x760mm) Models



Description	Fits Cart	Width/Height/Depth (in.) (mm)		Approx. Pkd. Wt. (lbs.) (kg)		Cat. No.
		(in.)	(mm)	(lbs.)	(kg)	
Wastebasket (including holder)	BC1627	17 <sup>3</sup> / <sub>8</sub> x27 <sup>1</sup> / <sub>2</sub> x13 <sup>1</sup> / <sub>4</sub>	440x700x337	5.5	2.5	<b>BCWB1</b>
Wastebasket (including holder)	BC2030	21 <sup>1</sup> / <sub>4</sub> x27 <sup>1</sup> / <sub>2</sub> x13 <sup>1</sup> / <sub>4</sub>	540x700x337	8.0	3.8	<b>BCWB2</b>
Utility Bin (including holder)	BC1627	17 <sup>1</sup> / <sub>2</sub> x7 <sup>3</sup> / <sub>4</sub> x14 <sup>1</sup> / <sub>2</sub>	445x197x368	3.8	1.7	<b>BCUB1</b>
Utility Bin (including holder)	BC2030	21 <sup>1</sup> / <sub>4</sub> x7 <sup>3</sup> / <sub>4</sub> x14 <sup>1</sup> / <sub>2</sub>	540x197x368	6.0	2.7	<b>BCUB2</b>
Wastebasket Only	—	14 <sup>3</sup> / <sub>8</sub> x15 <sup>3</sup> / <sub>8</sub> x10 <sup>3</sup> / <sub>8</sub>	365x391x264	2.8	1.3	<b>MF222</b>
Utility Bin Only	—	16 <sup>3</sup> / <sub>8</sub> x6x11	416x152x279	2.0	.9	<b>UB1</b>



Gray (G)



Blue (BU)



Slate Blue with Microban Antimicrobial (MB)



Black (BL)

### Deep Ledge Utility Carts — 12.28

Specially designed with a 2<sup>3</sup>/<sub>4</sub>" (70mm) deep ledge to contain product and spills.

- Easy-to-position center shelf option adjusts at 1" (25mm) increments.
- Polymer shelves are easy to clean and corrosion proof.
- Shelves with Microban® antimicrobial helps keep shelves "cleaner between cleanings" by inhibiting the growth of bacteria, mold, and mildew that cause odors, stains and product degradation. Slate blue color.
- 2-shelf and 3-shelf models are available in four colors including: Gray, Blue, Black and Slate Blue.

(in.)	Width/Length/Height (mm)	Description	Approx. Pkd. Wt. (lbs.) (kg)		Cat. No.*
21 <sup>1</sup> / <sub>2</sub> x32 <sup>3</sup> / <sub>4</sub> x41	546x832x1041	2-shelf unit	29	31.1	BC2030-2D
21 <sup>1</sup> / <sub>2</sub> x32 <sup>3</sup> / <sub>4</sub> x41	546x832x1041	3-shelf unit	37 <sup>1</sup> / <sub>2</sub>	17.0	BC2030-3D
27x38 <sup>3</sup> / <sub>4</sub> x41	685x984x1041	2-shelf unit	35	15.9	BC2636-2D
27x38 <sup>3</sup> / <sub>4</sub> x41	685x984x1041	3-shelf unit	46 <sup>1</sup> / <sub>2</sub>	21.1	BC2636-3D
21 <sup>1</sup> / <sub>2</sub> x32 <sup>3</sup> / <sub>4</sub> x41	546x832x1041	Antimicrobial 2-shelf unit	29	13.1	BC2030-2DMB
21 <sup>1</sup> / <sub>2</sub> x32 <sup>3</sup> / <sub>4</sub> x41	546x832x1041	Antimicrobial 3-shelf unit	37 <sup>1</sup> / <sub>2</sub>	17.0	BC2030-3DMB

\*Add color designation to part number when specifying, i.e.: BC2030-3DG = Three-shelf deep ledge cart in Gray.

(G) = Gray  
(BU) = Blue  
(BL) = Black  
(MB) = Slate Blue with Microban Antimicrobial



Weight Load Capacity:  
150 lbs. (68kg) per shelf.  
400 lbs. (181kg) per unit.

### Utility Cart Accessories — 12.28

Baskets and Bins for Deep Ledge

Description	Fits Cart	Width/Height/Depth (in.) (mm)		Approx. Pkd. Wt. (lbs.) (kg)		Cat. No.
Wastebasket (including holder)	BC2030	21 <sup>1</sup> / <sub>4</sub> x27 <sup>1</sup> / <sub>2</sub> x13 <sup>1</sup> / <sub>4</sub>	540x700x337	8.0	3.8	BCWB2D
Utility Bin (including holder)	BC2030	21 <sup>1</sup> / <sub>4</sub> x7 <sup>3</sup> / <sub>4</sub> x14 <sup>1</sup> / <sub>2</sub>	540x197x368	6.0	2.7	BCUB2D
Wastebasket Only	—	14 <sup>3</sup> / <sub>8</sub> x15 <sup>3</sup> / <sub>8</sub> x10 <sup>3</sup> / <sub>8</sub>	365x391x264	2.8	1.3	MF222
Utility Bin Only	—	16 <sup>3</sup> / <sub>8</sub> x6x11	416x152x279	2.0	.9	UB1



Microban  
3-Shelf Deep Ledge Cart

### Replacement Casters for BC Series and Deep Ledge Utility Carts

4 per box.

Cat. No. **RPBC4M-4**



\*MICROBAN® and the MICROBAN® symbol are registered trademarks of the Microban Products Company, Huntersville, NC.



MW200 Series

## MW Series Utility Carts — 12.01

- Consist of Super Erecta wire shelves with plastic split sleeves, two one-piece handles of matching finish, and designated casters with donut bumpers.
- Two- and three-tier models available.
- 375 lbs. (170kg) weight capacity per cart. MW carts use light-duty resilient casters.
- 18" (457mm) wide carts have 4" (102mm) casters. Cart is 38" (965mm) high.
- 21" and 24" (530 and 610mm) wide carts have 5" (127mm) casters. Cart is 39" (990mm) high.

### Utility Carts with Stainless Steel Solid Shelves

Width/Length (in.)	Width/Length (mm)	Approx. Pkd. Wt. (lbs.)	Approx. Pkd. Wt. (kg)	Cat. No. 2-Shelf	List Price Each	Approx. Pkd. Wt. (lbs.)	Approx. Pkd. Wt. (kg)	Cat. No. 3-Shelf
18x24	457x610	40	18.1	<b>MW103</b>	657.00	48	21.8	<b>MW203</b>
18x30	457x760	45	20.4	<b>MW104</b>	743.00	53	24.0	<b>MW204</b>
18x36	457x914	48	21.8	<b>MW105</b>	743.00	59	26.8	<b>MW205</b>
21x36	530x914	54	24.5	<b>MW106</b>	803.00	74	33.6	<b>MW206</b>
24x36	610x914	60	27.2	<b>MW108</b>	849.50	66	29.9	<b>MW208</b>



MW400 Series

### Utility Carts with 1 Solid, 2 Wire Shelves

Width/Length (in.)	Width/Length (mm)	Approx. Pkd. Wt. (lbs.)	Approx. Pkd. Wt. (kg)	Shelf Material	Handles	Cat. No.
18x24	457x610	43	19.5	Stainless Steel, Chrome	Chrome	<b>MW401</b>
18x30	457x760	47	21.3	Stainless Steel, Chrome	Chrome	<b>MW402</b>
18x36	457x914	52	23.6	Stainless Steel, Chrome	Chrome	<b>MW403</b>
21x36	530x914	59	26.8	Stainless Steel, Chrome	Chrome	<b>MW404</b>
24x36	610x914	65	29.5	Stainless Steel, Chrome	Chrome	<b>MW406</b>



MW600 Series

### Utility Carts with 2 Wire Shelves

Width/Length (in.)	Width/Length (mm)	Approx. Pkd. Wt. (lbs.)	Approx. Pkd. Wt. (kg)	Shelf Material	Handles	Cat. No.
18x24	457x610	34	15.4	Chrome	Chrome	<b>MW601</b>
18x24	457x610	34	15.4	Stainless Steel	Stainless Steel	<b>MW602</b>
18x30	457x760	37	16.8	Chrome	Chrome	<b>MW603</b>
18x30	457x760	37	16.8	Stainless Steel	Stainless Steel	<b>MW604</b>
18x36	457x914	40	18.1	Chrome	Chrome	<b>MW605</b>
18x36	457x914	39	17.7	Stainless Steel	Stainless Steel	<b>MW606</b>
21x36	530x914	44	20.0	Chrome	Chrome	<b>MW607</b>
21x36	530x914	44	20.0	Stainless Steel	Stainless Steel	<b>MW608</b>
24x36	610x914	47	21.3	Chrome	Chrome	<b>MW611</b>
24x36	610x914	46	20.9	Stainless Steel	Stainless Steel	<b>MW612</b>



MW700 Series

### Utility Carts with 3 Wire Shelves

Width/Length (in.)	Width/Length (mm)	Approx. Pkd. Wt. (lbs.)	Approx. Pkd. Wt. (kg)	Shelf Material	Handles	Cat. No.
18x24	457x610	39	17.6	Chrome	Chrome	<b>MW701</b>
18x24	457x610	38	17.2	Stainless Steel	Stainless Steel	<b>MW702</b>
18x30	457x760	43	19.5	Chrome	Chrome	<b>MW703</b>
18x30	457x760	42	19.1	Stainless Steel	Stainless Steel	<b>MW704</b>
18x36	457x914	47	21.3	Chrome	Chrome	<b>MW705</b>
18x36	457x914	45	20.4	Stainless Steel	Stainless Steel	<b>MW706</b>
21x36	530x914	50	22.7	Chrome	Chrome	<b>MW707</b>
21x36	530x914	50	22.7	Stainless Steel	Stainless Steel	<b>MW708</b>
24x36	610x914	60	27.7	Chrome	Chrome	<b>MW711</b>
24x36	610x914	57	25.9	Stainless Steel	Stainless Steel	<b>MW712</b>

## SP Series Utility Carts

- Consist of Super Erecta wire shelves with plastic split sleeves, two one-piece handles of matching finish, and designated casters with donut bumpers.
- Two- and three-tier models available.
- 5" (127mm) casters allow for transport of heavier loads than the MW Series Carts.
- 39" (990mm) high.



2-Tier with 5M casters

Super Erecta Brite finish — 600 lbs. (273kg) capacity per cart

- 5M Resilient Rubber Casters; casters have plated horns and axles.

Shelf Width/Length (in.)	Shelf Width/Length (mm)	2-TIER MODELS		3-TIER MODELS	
		Approx. Pkd. Wt. (lbs.)	Cat. No. Super Erecta Brite	Approx. Pkd. Wt. (lbs.)	Cat. No. Super Erecta Brite
18x36	457x914	40 18	<b>2SPN33ABR</b>	50 22.5	<b>3SPN33ABR</b>
21x36	530x914	44 20	<b>2SPN43ABR</b>	55 24.7	<b>3SPN43ABR</b>
24x36	610x914	48 22	<b>2SPN53ABR</b>	61 27.4	<b>3SPN53ABR</b>
24x48	610x1219	54 24	<b>2SPN55ABR</b>	70 31.5	<b>3SPN55ABR</b>
24x60	610x1524	64 29	<b>2SPN56ABR</b>	85 38.2	<b>3SPN56ABR</b>



3-Tier with 5MP casters

Chrome finish — 900 lbs. (410kg) capacity per cart

- 5MP Polyurethane Casters; casters have plated horns and axles.

Shelf Width/Length (in.)	Shelf Width/Length (mm)	2-TIER MODELS		3-TIER MODELS	
		Approx. Pkd. Wt. (lbs.)	Cat. No. Chrome	Approx. Pkd. Wt. (lbs.)	Cat. No. Chrome
18x36	457x914	40 18	<b>2SPN33DC</b>	50 22.5	<b>3SPN33DC</b>
21x36	530x914	44 20	<b>2SPN43DC</b>	55 24.7	<b>3SPN43DC</b>
24x36	610x914	48 22	<b>2SPN53DC</b>	61 27.4	<b>3SPN53DC</b>
24x48	610x1219	54 24	<b>2SPN55DC</b>	70 31.5	<b>3SPN55DC</b>
24x60	610x1524	64 29	<b>2SPN56DC</b>	85 38.2	<b>3SPN56DC</b>



3-Tier with 5PC casters

Type 304 Stainless Steel — 900 lbs. (410kg) capacity per cart

- 5PC Polyurethane Casters; casters have polymer horns and stainless steel axles.

Shelf Width/Length (in.)	Shelf Width/Length (mm)	2-TIER MODELS		3-TIER MODELS	
		Approx. Pkd. Wt. (lbs.)	Cat. No. Stainless Steel	Approx. Pkd. Wt. (lbs.)	Cat. No. Stainless Steel
18x36	457x914	40 18	<b>2SPN33PS</b>	50 22.5	<b>3SPN33PS</b>
21x36	530x914	44 20	<b>2SPN43PS</b>	55 24.7	<b>3SPN43PS</b>
24x36	610x914	48 22	<b>2SPN53PS</b>	61 27.4	<b>3SPN53PS</b>
24x48	610x1219	54 24	<b>2SPN55PS</b>	70 31.5	<b>3SPN55PS</b>
24x60	610x1524	64 29	<b>2SPN56PS</b>	85 38.2	<b>3SPN56PS</b>

## One-Piece Handles — 12.20

May be used with Super Erecta shelving, casters, and components to customize a cart to your exact needs.

Shelf Width/Length (in.)	Shelf Width/Length (mm)	Approx. Pkd. Wt. (lbs.)	Approx. Pkd. Wt. (kg)	Cat. No. Chrome	Cat. No. Stainless Steel
18	457	5½	2.5	<b>H3C</b>	<b>H3S</b>
21	533	5¾	2.6	<b>H4C</b>	<b>H4S</b>
24	610	6	2.7	<b>H5C</b>	<b>H5S</b>

Height: 34½" (876mm).



One-Piece Handle



# HIGH-DENSITY STORAGE, DUNNAGE & SECURITY

High-Density Movable Aisle Shelving .....	88-95
Vertical High-Density Shelving .....	96
Dunnage Racks & Shelves .....	97-98
Security Storage.....	99-103
Seismic Shelving .....	104-105

# So smart...

## qwikTRAK® High-Density Storage



BOOST  
STORAGE SPACE  
BY UP TO  
**50%**  
WITH NO ADDED  
CONSTRUCTION  
COSTS.

### qwikTRAK key facts

The aluminum and stainless steel floor tracks provide a smooth, gliding surface for mobile units.

- Mobile units are designed to move easily and store heavy weight loads. MetroMax i mobile qwikTRAK units can hold up to 1,200 lbs. (544kg). MetroMax Q, Super Adjustable, and Super Erecta mobile qwikTRAK units can hold up to 2,000 lbs. (907kg).
- Floor tracks protect the floors from wear and tear and do not require to be mounted to the floor.
- Floor tracks compensate for rough or choppy floor surfaces.

**Double-Deep Configurations** can be created where two systems are joined together to increase the overall depth of the storage system for even greater storage capacity.

**Choose the shelving type based on the application.**

Both single- and double-deep systems can be used with Metro wire shelving (Super Erecta or Super Adjustable Super Erecta) and polymer shelving systems (MetroMax i and MetroMax Q).



THE SECRET TO  
HIGH-DENSITY  
STORAGE IS THE  
**ACTIVE  
AISLE**  
CONCEPT.



# it's dense.

Top-Track® High-Density Storage



**ADA Compliant**

### Top-Track key facts

The guide track is positioned above the shelving system.

- Floors are easy to clean.
- Utility carts can easily be rolled into and out of the active aisle.
- The guide track compensates for uneven floor surfaces and keeps units in alignment.
- Mobile units are designed to address medium-duty applications. The weight capacity of a Top-Track mobile unit is 900 lb. (410kg).

Choose the shelving type based on your application.

Top-Track (single deep) can be used with Metro wire shelving (Super Erecta or Super Adjustable Super Erecta) and polymer shelving systems (MetroMax i and MetroMax Q).

Double-Deep configurations can be created when two systems are joined together to increase the overall depth of the storage system for even greater storage capacity. Double-Deep Top-Track is only available for Super Erecta and Super Adjustable Super Erecta style shelving.



TRADITIONAL STORAGE USES UP TO 20' OF SPACE

HIGH DENSITY STORAGE . . . THE SMART WAY TO PUT SPACE TO WORK.



11.5'



High-Density qwikTRAK® Storage Systems for: Super Erecta, Super Erecta Pro™, Super Adjustable, MetroMax Q, and MetroMax i Systems.



MetroMax i qwikTRAK

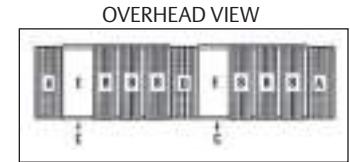
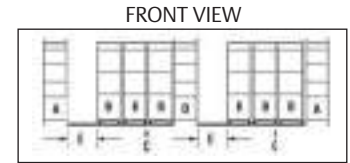

SYSTEM COMPONENTS

- A = Stationary End Units
- B = Mobile Units
- C = qwikTRAK
- D = Stationary Intermediate Unit
- E = Active Aisle



Grooved casters fit securely on track.

Shelves Sold Separately

- Super Erecta — Pg. 42
- Super Erecta Pro — Pg. 34
- Super Adjustable — Pg. 37
- MetroMax Q — Pg. 15
- MetroMax i — Pg. 14

qwikTRAK Storage System — 11.15

Stationary End Unit Kits

Includes 74" high posts (1880mm) high stationary posts, and hardware necessary for connecting stationary end units to tracks and anchoring tracks to the floor. Order one kit per system. Shelves are sold separately.

Super Erecta, Super Erecta Pro, Super Adjustable Super Erecta				MetroMax Q			MetroMax i			
Approx. Pkd. Wt. (lbs.)	Approx. Pkd. Wt. (kg)	Cat. No. Chrome-Plated	Cat. No. Metroseal 3 with Microban®	Cat. No. Stainless Steel	Approx. Pkd. Wt. (lbs.)	Approx. Pkd. Wt. (kg)	Cat. No.	Approx. Pkd. Wt. (lbs.)	Approx. Pkd. Wt. (kg)	Cat. No.
39.6	18.0	BTEC	BTEK3	BTES	42.0	19.1	BTEQ3	25.0	11.4	BTEX3

Stationary Intermediate Unit Kits

Includes 74" high posts (1880mm) high stationary posts, and hardware necessary for connecting one stationary intermediate unit to tracks and anchoring tracks to the floor. Shelves are sold separately.

Super Erecta, Super Erecta Pro, Super Adjustable Super Erecta				MetroMax Q			MetroMax i			
Approx. Pkd. Wt. (lbs.)	Approx. Pkd. Wt. (kg)	Cat. No. Chrome-Plated	Cat. No. Metroseal 3 with Microban®	Cat. No. Stainless Steel	Approx. Pkd. Wt. (lbs.)	Approx. Pkd. Wt. (kg)	Cat. No.	Approx. Pkd. Wt. (lbs.)	Approx. Pkd. Wt. (kg)	Cat. No.
22.6	10.3	BTAC	BTAK3	BTAS	24.2	11.0	BTAQ3	15.7	7.1	BTAx3

Mobile Unit Kits

Includes four 74" high posts (1880mm) high mobile posts, four casters, donut bumpers, and other hardware to assemble a mobile unit. Shelves are sold separately. One kit required per mobile unit.

Super Erecta, Super Erecta Pro, Super Adjustable Super Erecta				MetroMax Q			MetroMax i			
Approx. Pkd. Wt. (lbs.)	Approx. Pkd. Wt. (kg)	Cat. No. Chrome-Plated	Cat. No. Metroseal 3 with Microban®	Cat. No. Stainless Steel	Approx. Pkd. Wt. (lbs.)	Approx. Pkd. Wt. (kg)	Cat. No.	Approx. Pkd. Wt. (lbs.)	Approx. Pkd. Wt. (kg)	Cat. No.
25.0	11.4	BTMC	BTMK3	BTMS	27.0	12.3	BTMQ3	18.5	8.4	BTMX3

Track Sets

Includes tracks and hardware needed to assemble track runs up to 21' (6400mm).

Length (ft.)	Length (mm)	Approx. Pkd. Wt. (lbs.)	Approx. Pkd. Wt. (kg)	Cat. No.	Length (ft.)	Length (mm)	Approx. Pkd. Wt. (lbs.)	Approx. Pkd. Wt. (kg)	Cat. No.
2.5	762	4	1.8	BTS2.5NA	14	4267	19	8.6	BTS14NA
6	1828	9	4.1	BTS6NA	15	4572	21	9.5	BTS15NA
7	2135	10	4.5	BTS7NA	16	4877	22	10.0	BTS16NA
8	2440	11	5.0	BTS8NA	17	5182	23	10.5	BTS17NA
9	2473	13	5.9	BTS9NA	18	5486	25	11.4	BTS18NA
10	3048	14	6.4	BTS10NA	19	5791	26	11.8	BTS19NA
11	3352	15	6.8	BTS11NA	20	6096	27	12.3	BTS20NA
12	3657	17	7.7	BTS12NA	21	6400	29	13.2	BTS21NA
13	3962	18	8.2	BTS13NA					

Note: BTS2.5NA includes a joining kit to connect the tracks to other track sets.

Indicates antimicrobial product.

Notes:

1. All end, intermediate, and mobile units must be 18" (457mm) or wider.
2. Each stationary end and intermediate unit must have a minimum of four shelves. Super Adjustable shelves may be used for all tiers.
3. qwikTRAK is available with 74" posts (1880mm) as standard. Requests for TALLER posts must be reviewed by Metro Engineering. For applications requiring posts SHORTER than 74" (1880mm), contact your Metro representative.
4. Existing Metro Super Erecta, Super Adjustable, MetroMax Q, and MetroMax i shelving units can be retrofitted as part of a HD qwikTRAK installation.
5. Under normal conditions, aisle width of 30"-36" (760-914mm) is recommended. The storage of very large objects within the system, however, may require an aisle width larger than 36" (914mm).
6. A stationary intermediate unit is required when the track length exceeds 21 feet (6400mm). A stationary intermediate unit may be used at the discretion of the user when the track lengths are less than 21 ft. (6400mm).
7. It is recommended that the tracks are installed a minimum of 1 3/4" (45mm) from the wall.
8. Actual width of a qwikTRAK system is the Nominal Shelf length + 3 1/2" (89mm).
9. Actual height of a mobile qwikTRAK unit is: Nominal post height + 4.5" (115mm)
10. Actual length of a qwikTRAK system is: Nominal track length + the nominal width of each end unit + 3" (76mm)
11. Weight capacities for standard qwikTRAK: Super Erecta, Super Adjustable, MetroMax Q systems are designed to hold up to 2,000 lbs. (907kg) per shelving unit. MetroMax i stationary units can hold up to 2,000 lbs. (907kg); MetroMax i mobile units can hold up to 1,200 lbs. (544kg) per unit.



# HIGH-DENSITY — QWIKTRAK® DOUBLE-DEEP

Double-Deep qwikTRAK® Storage System for: Super Erecta, Super Erecta Pro, Super Adjustable, MetroMax Q, and MetroMax i Systems.

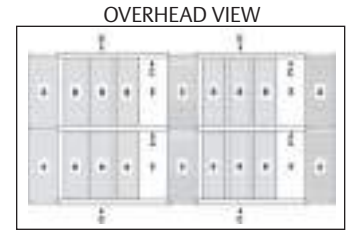
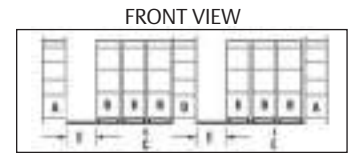

**SYSTEM COMPONENTS**  
 A = Stationary End Units  
 B = Mobile Units  
 C = qwikTRAK  
 D = Stationary Intermediate Unit  
 E = Active Aisle

**Shelves Sold Separately**  
 Super Erecta — Pg. 42  
 Super Erecta Pro — Pg. 34  
 Super Adjustable — Pg. 37  
 MetroMax Q — Pg. 15  
 MetroMax i — Pg. 14

## Double-Deep qwikTRAK — 11.15

### Stationary End Unit Kits

Includes 74" high posts (1880mm) high stationary posts and hardware necessary for connecting stationary end units to tracks and anchoring tracks to the floor. Order one kit per double-deep system. Shelves are sold separately.

Super Erecta, Super Erecta Pro, Super Adjustable Super Erecta				MetroMax Q			MetroMax i			
Approx. Pkd. Wt. (lbs.)		Cat. No. Chrome-Plated	Cat. No. Metroseal 3 with Microban®	Cat. No. Stainless Steel	Approx. Pkd. Wt. (lbs.)		Cat. No.	Approx. Pkd. Wt. (lbs.)		Cat. No.
73.6	33.5	LBTEC	LBTEK3	LBTES	76.3	34.7	LBTEQ3	42.3	19.2	LBTEX3

### Stationary Intermediate Unit Kits

Includes 74" high posts (1880mm) high stationary posts and hardware necessary for connecting one double-deep stationary intermediate unit to tracks and anchoring tracks to the floor. Shelves are sold separately.

Super Erecta, Super Erecta Pro, Super Adjustable Super Erecta				MetroMax Q			MetroMax i			
Approx. Pkd. Wt. (lbs.)		Cat. No. Chrome-Plated	Cat. No. Metroseal 3 with Microban®	Cat. No. Stainless Steel	Approx. Pkd. Wt. (lbs.)		Cat. No.	Approx. Pkd. Wt. (lbs.)		Cat. No.
39.6	18.0	LBTAC	LBTAK3	LBTAS	41.3	18.8	LBTAQ3	24.3	11.0	LBTAX3

### Mobile Units

Includes (8) 74" (1880mm) high -UP posts, (4) V-groove casters, (1) stainless steel center channel caster assembly, donut bumpers, Tie Bar Brackets, and other hardware. Shelves are sold separately. One kit required per Double-Deep Mobile Unit.

Super Erecta, Super Erecta Pro, Super Adjustable Super Erecta				MetroMax Q			MetroMax i		
Shelf Width (in.)		Cat. No. Chrome	Cat. No. Metroseal 3 with Microban®	Cat. No. Stainless Steel	Cat. No.	Cat. No.	Cat. No.	Cat. No.	
18	457	LBTM18C	LBTM18K3	LBTM18S	LBTM18Q3	LBTM18X3			
21	530	LBTM21C	LBTM21K3	LBTM21S	LBTM21Q3	—			
24	610	LBTM24C	LBTM24K3	LBTM24S	LBTM24Q3	LBTM24X3			

### Track Sets

Includes tracks and hardware needed to assemble Double-Deep qwikTRAK systems up to 21' (6400mm).

Length (ft.)		Approx. Pkd. Wt. (lbs.)		Cat. No.	Length (ft.)		Approx. Pkd. Wt. (lbs.)		Cat. No.
2.5	762	4	1.8	LBTS2.5NA	14	4267	19	8.6	LBTS14NA
6	1828	9	4.1	LBTS6NA	15	4572	21	9.5	LBTS15NA
7	2135	10	4.5	LBTS7NA	16	4877	22	10.0	LBTS16NA
8	2440	11	5.0	LBTS8NA	17	5182	23	10.5	LBTS17NA
9	2473	13	5.9	LBTS9NA	18	5486	25	11.4	LBTS18NA
10	3048	14	6.4	LBTS10NA	19	5791	26	11.8	LBTS19NA
11	3352	15	6.8	LBTS11NA	20	6096	27	12.3	LBTS20NA
12	3657	17	7.7	LBTS12NA	21	6400	29	13.2	VTS21NA
13	3962	18	8.2	LBTS13NA					

**Note:** LBTS2.5NA includes a joining kit to connect the tracks to other track sets. **Note:** LBTS2.5NA includes a joining kit to connect the track to other track sets.

Ⓢ Indicates antimicrobial product.

### Notes:

- All end, intermediate, and mobile units must be 18" (457mm) or wider.
- Each stationary end and intermediate unit must have a minimum of four shelves. Top and bottom Super Erecta shelves are required on all units with Super Adjustable shelves.
- For applications with Super Adjustable wire shelves, the top and bottom shelf of every double deep mobile unit MUST be standard Super Erecta wire shelves.
- qwikTRAK is available with 74" posts (1880mm) as standard. Requests for TALLER posts must be reviewed by Metro Engineering. For applications requiring posts SHORTER than 74" (1880mm), contact your Metro representative.
- Under normal conditions, aisle width of 30"-36" (760-914mm) is recommended. The storage of very large objects within the system, however, may require an aisle width larger than 36" (914mm).
- Two stationary intermediate units connected end to end are required when the track length exceeds 21 feet (6400mm). Stationary intermediate units may be used at the discretion of the user when the track lengths are less than 21 ft. (6400mm).
- It is recommended that the tracks are installed a minimum of 1/4" (45mm) from the wall.
- Maximum allowable shelf length for use with a double deep system is 60" (1524mm).
- The maximum width of a double deep configuration is 10'6" (3200mm). (i.e., two systems, each having 60" (1524mm) long shelves, plus 6" (150mm) for qwikTRAK components.
- Actual width of a double deep configuration is the Nominal Shelf Length + 3/2" (89mm).
- Weight capacities: Double Deep Mobile Units — Super Erecta/Super Adjustable, Super Erecta/MetroMax Q: 3,000 lbs. (1364kg) evenly distributed. MetroMax i: 1,800 lbs. (818kg) evenly distributed. Stationary End and Intermediate Units — Each end and intermediate double deep unit consists of two independent stationary shelving units positioned side by side. Each shelving unit has a maximum weight capacity of 2,000 lbs. (907kg).



Wire Shelving — Super Erecta®, Super Erecta Pro™ and Super Adjustable Top-Track — 11.12



Super Erecta® Top-Track®

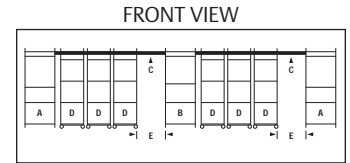

A = Stationary End Units  
 B = Stationary Intermediate Unit (Optional)  
 C = Track Set  
 D = Mobile Units  
 E = Open Aisle

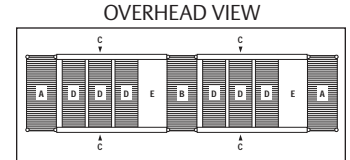

**Stationary End Unit Kits**

Includes hardware necessary for connecting stationary end units to track. One kit is required per single system. 86" (2185mm) posts are included. Shelves sold separately — See pages 34, 37 and 42.

Shelf Width (in.) (mm)	Approx. Pkd. Wt. (lbs.) (kg)	Cat. No. Chrome-Plated	Cat. No. Metroseal 3 with Microban®	Cat. No. Stainless Steel
18 457	11 4.9	TTE18C	TTE18K3	TTE18S
21 530	11.5 5.1	TTE21C	TTE21K3	TTE21S
24 610	12 5.4	TTE24C	TTE24K3	TTE24S



**Stationary Intermediate Unit Kits**

Includes hardware necessary for connecting intermediate unit to track on both sides. 86" (2185mm) posts are included. Shelves sold separately — See pages 34, 37 and 42.

Shelf Width (in.) (mm)	Approx. Pkd. Wt. (lbs.) (kg)	Cat. No. Chrome-Plated	Cat. No. Metroseal 3 with Microban®	Cat. No. Stainless Steel
18 457	7.5 3.3	TTA18C	TTA18K3	TTA18S
21 530	8 3.6	TTA21C	TTA21K3	TTA21S
24 610	8.5 3.8	TTA24C	TTA24K3	TTA24S

Refer to pages 53-60 for a complete selection of Super Erecta Shelf accessories. For Top-Track accessories, see page 96.

**Track Sets**

Includes necessary sections of track for assembling track runs up to 21' (6400mm).

Length (feet) (mm)	Approx. Pkd. Wt. (lbs.) (kg)	Cat. No.
2½ 762	15 6.8	TTS2.5NA
6 1828	40.5 18.2	TTS6NA
7 2135	47.5 21.3	TTS7NA
8 2440	56 25.2	TTS8NA
9 2743	62.5 28.1	TTS9NA
10 3048	69.5 31.2	TTS10NA
11 3353	76.5 34.4	TTS11NA
12 3657	83.5 37.5	TTS12NA
13 3962	92 41.4	TTS13NA

Length (feet) (mm)	Approx. Pkd. Wt. (lbs.) (kg)	Cat. No.
14 4267	98 44.1	TTS14NA
15 4572	106.5 47.9	TTS15NA
16 4877	113.5 51	TTS16NA
17 5182	121 54.4	TTS17NA
18 5486	128 51.6	TTS18NA
19 5791	135 60.7	TTS19NA
20 6096	142 63.9	TTS20NA
21 6400	149 67	TTS21NA

Note: TTS2.5NA includes a joining kit to connect the track to other track sets.

**Mobile Unit Kits** (shelves sold separately — see pages 34, 37 and 42)

One kit required per mobile unit. Kit includes posts, casters/caster channels, donut bumpers, and roller bearing assemblies.

Shelf Width (in.) (mm)	Overall Width (in.) (mm)	Approx. Pkd. Wt. (lbs.) (kg)	Cat. No. Chrome-Plated	Cat. No. Metroseal 3 with Microban®	Cat. No. Stainless Steel
18 457	20¼ 514	32 14.4	TTM18C	TTM18K3	TTM18S
21 530	23¼ 590	33 14.8	TTM21C	TTM21K3	TTM21S
24 610	26¼ 667	34 15.3	TTM24C	TTM24K3	TTM24S

**Notes:**

- Each stationary end and intermediate unit must have a minimum of four shelves. For all Super Adjustable applications, the top and bottom shelves must be non "quick adjust" Super Erecta shelves.
- The standard Deep Top-Track system requires the use of 86" (2185mm) posts (i.e., 86P, 86PK, or 86PS) on the stationary end and intermediate units. Shelves for the stationary end and intermediate units are sold separately.
- The mobile unit kit include special 74" (1880mm) posts with casters. Shelves for mobile units are sold separately.
- Recommended maximum load rating for a mobile unit is 900 lbs. (410kg). Floor should be level, smooth, and free from large cracks and raised obstacles.
- Under normal conditions, an aisle width of 30"-36" (760-914mm) is recommended. The storage of very large objects within the system, however, may require an aisle width larger than 36" (914mm).
- A stationary intermediate unit is required when track length exceeds 21 feet (6400mm). A stationary intermediate unit may be used at the discretion of the user when track lengths are less than 21 feet (6400mm).
- To accommodate bumpers, the actual size of a mobile unit is 2.5" (63.5mm) wider than the shelf width shown. For example, an 18" (457mm) wide unit is actually 20.5" (522mm).
- To calculate the overall length of a Super Erecta Top Track System, add the following: Nominal track length + Nominal widths of each end unit + 1.5" (38mm).

✓ Indicates antimicrobial product.

Super Erecta® and Super Adjustable Double-Deep Top-Track® — 11.12

**Stationary End Unit Kits**

Includes hardware necessary for connecting stationary end units in Double Deep systems and connecting to an overhead track set. One kit is required for the entire double deep configuration. Shelves sold separately — See pages 37 and 42. 86" (2185mm) posts included.

Shelf Width (in.) (mm)	Approx. Pkd. Wt. (lbs.) (kg)	Cat. No. Chrome-Plated
18 457	33 14.8	LTTE18C
21 530	37 16.6	LTTE21C
24 610	41 18.4	LTTE24C

**Stationary Intermediate Unit Kits**

Includes hardware necessary for connecting intermediate units in Double Deep systems and connecting to an overhead track set on each side. One kit is required for Intermediate units connected end-to-end. Shelves sold separately — See pages 37 and 42. 86" (2185mm) posts included.

Shelf Width (in.) (mm)	Approx. Pkd. Wt. (lbs.) (kg)	Cat. No. Chrome-Plated
18 457	18 8	LTTA18C
21 530	20 9	LTTA21C
24 610	22 9.9	LTTA24C

**Track Sets**

Includes necessary sections of track for assembling track runs up to 21' (6400mm). For track sizes within the even 1-foot (305mm) increments, contact your Metro representative. Only one track set is required between stationary units.

Length (feet) (mm)	Approx. Pkd. Wt. (lbs.) (kg)	Cat. No.
2½ 762	15 6.8	TTS2.5NA
6 1828	40.5 18.2	TTS6NA
7 2135	47.5 21.3	TTS7NA
8 2440	56 25.2	TTS8NA
9 2743	62.5 28.1	TTS9NA
10 3048	69.5 31.2	TTS10NA
11 3353	76.5 34.4	TTS11NA
12 3657	83.5 37.5	TTS12NA
13 3962	92 41.4	TTS13NA

Length (feet) (mm)	Approx. Pkd. Wt. (lbs.) (kg)	Cat. No.
14 4267	98 44.1	TTS14NA
15 4572	106.5 47.9	TTS15NA
16 4877	113.5 51	TTS16NA
17 5182	121 54.4	TTS17NA
18 5486	128 51.6	TTS18NA
19 5791	135 60.7	TTS19NA
20 6096	142 63.9	TTS20NA
21 6400	149 67	TTS21NA

**Note:** TTS2.5NA includes a joining kit to connect the track to other track sets.

**Mobile Unit Kits**

Includes posts, casters, caster channels, donut bumpers, roller bearing assemblies, and tie-together hardware to connect two mobile units (i.e., one in each system). Shelves sold separately — See pages 37 and 42.

Shelf Width (in.) (mm)	Overall Width (in.) (mm)	Approx. Pkd. Wt. (lbs.) (kg)	Cat. No. Chrome-Plated
18 457	20¼ 514	72 32.4	LTTM18C
21 530	23¼ 590	75 33.7	LTTM21C
24 610	26¼ 667	78 35	LTTM24C

**Notes:**

- Each stationary end and intermediate unit **must** have a minimum of four shelves. For all Super Adjustable applications, the top and bottom shelves must be non "quick adjust" Super Erecta shelves.
- The standard Double Deep Top-Track system requires the use of 86" (2185mm) posts (i.e., 86P) on the stationary end and intermediate units. **Shelves for the stationary end and intermediate units are sold separately.**
- The mobile unit kits include special 74" (1880mm) posts with casters. **Shelves for mobile units are sold separately.**
- Under normal conditions, an aisle width of 30"-36" (760-914mm) is recommended. The storage of very large objects within the system, however, may require an aisle width larger than 36" (914mm).
- Two intermediate shelving units connected end-to-end are required when the track length exceeds 21 feet (6400mm). Stationary intermediate shelving units may be used at the discretion of the user when track lengths are less than 21 feet (6400mm).
- The maximum Double Deep system configuration is 10'6" (3200mm) (i.e., two systems, each having 60" (1524mm) long shelves, plus 6" (150mm) for Top-Track components).
- Ease of rollability for the mobile units is an important consideration in evaluating Top-Track as a possible storage alternative. The floor should be level, smooth, and free from large cracks and raised obstacles. Two mobile shelving units connected end-to-end and loaded with between 800 to 1,200 lbs. (365-550kg) will require a human effort range (in lbs. of human force) of between 18-24 lbs. (8-11kg) to move the unit from a complete stop. Subjectively, an average 110 lb. (50kg) person will perceive this as acceptable effort levels. For loads over 1,200 lbs. (550kg), contact your Metro representative.
- Mobile units should have the top shelf positioned as close as possible to the track.
- To accommodate bumpers, the actual size of a mobile unit is 2.5" (63.5mm) wider than the shelf width shown. For example, an 18" (457mm) wide unit is actually 20.5" (52mm).
- To calculate the overall length of a Super Erecta Top Track System, add the following: Nominal track length + Nominal widths of each end unit + 1.5" (38mm).

FRONT VIEW

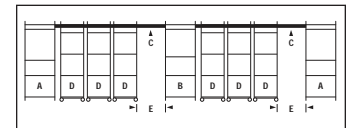

- A = Stationary End Units
- B = Stationary Intermediate Unit (Optional)
- C = Track Set
- D = Mobile Units
- E = Open Aisle

OVERHEAD VIEW

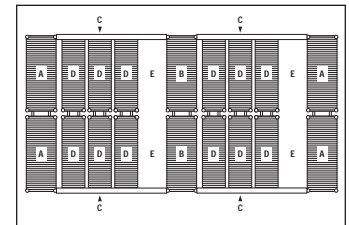

For Top-Track accessories, see page 96.

## Seismic Top-Track® Single Length System

### End Unit Kit:

Includes four shelves, four staked posts, bracket bars, sway braces (for top, back, and end), anchor plates, foot plates, tubular braces, clamps, and assembly hardware.

Description	Cat. No.
Kit for 48" (1219mm) Stationary End Unit	SA48TTS
Kit for 54" (1370mm) Stationary End Unit	SA54TTS
Kit for 60" (1524mm) Stationary End Unit	SA60TTS

### Strut Kit:

Description	Cat. No.
Kit for 48" (1219mm) Wide Unit	TTB48STRUT
Kit for 54" (1370mm) Wide Unit	TTB54STRUT
Kit for 60" (1524mm) Wide Unit	TTB60STRUT

**Note:** Floor anchoring hardware not included.

Example: For a complete "Single-Length Top-Track® System," the following would be required: Two Stationary End Units, One Track Set\* (11-foot [3355mm] maximum), One Center Strut (if track length exceeds 7 feet), Mobile Units.

Note: Posts and shelves are included in the end and intermediate unit kits. Shelves are sold separately for the mobile unit.

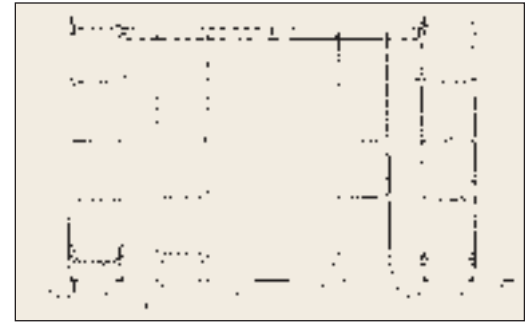

Single-Length System

Add track sets and mobile unit kits, refer to page 92.

## Seismic Top-Track® Double Length System

### End Unit Kit:

Includes four shelves, four staked posts, bracket bars, sway braces (for top, back, and end), anchor plates, foot plates, tubular braces, clamps, and assembly hardware.

Description	Cat. No.
Kit for 48" (1219mm) Stationary End Unit	SA48TTS
Kit for 54" (1370mm) Stationary End Unit	SA54TTS
Kit for 60" (1524mm) Stationary End Unit	SA60TTS

### OSHPD Preapproved Intermediate Unit Kit:

Includes eight shelves, eight staked posts, bracket bars, sway braces (for top, back, and end), anchor plates, foot plates, tubular braces, clamps, and assembly hardware.

Description	Cat. No.
Kit for 48" (1219mm) Stationary Intermediate Unit	SA48TTIS
Kit for 54" (1370mm) Stationary Intermediate Unit	SA54TTIS
Kit for 60" (1524mm) Stationary Intermediate Unit	SA60TTIS

### Strut Kit:

Description	Cat. No.
Kit for 48" (1219mm) Wide Unit	TTB48STRUT
Kit for 54" (1370mm) Wide Unit	TTB54STRUT
Kit for 60" (1524mm) Wide Unit	TTB60STRUT

**Note:** Floor anchoring hardware not included.

Example: For a complete "Double-Length Top-Track® System," the following would be required: Two Stationary End Units, Two Track Sets\* (11-foot [3355mm] maximum), One Intermediate Unit, Two Center Struts (if track length exceeds 7 feet [2135mm]), Mobile Units.\*

Note: Posts and shelves are included in the end and intermediate unit kits. Shelves are sold separately for the mobile unit.

#### Notes:

- Each installation must have two stationary end units for a single-track length of 7' (2135mm) to 11' (3355mm).
- A center strut is required for each track section over 7' (2135mm).
- For track lengths over 11' (3355mm), an intermediate unit is required, thus creating a double-length system.
- OSHPD preapproval is based upon a weight-loading capacity of 25 lbs. (11kg) per square foot on a four-shelf stationary and mobile units, with maximum of 900 lbs. (408kg) per mobile unit. Additional shelves may be added, but are limited to a maximum load of 25 lbs. (11kg) per cubic foot per unit.
- A maximum of four 21" (640mm) or 24" (610mm), or five 18" (457mm) mobile units are allowed per an 11' (3355mm) track length, with no more than a 900 lb. (408kg) weight capacity per mobile unit.
- Stationary End Units are available in 24"x48" (610x1219mm), 24"x54" (610x1370mm), and 24"x60" (610x1524mm).
- OSHPD preapproved design is based on the use of HR concrete, at least 5 1/2" (140mm) thick, with a compressive strength of 3,000 psi (211kg/cm). Anchorage is not included.
- To calculate the overall length of a Super Erecta Top Track System, add the following: Nominal track length + Nominal widths of each end unit + 1.5" (38mm).

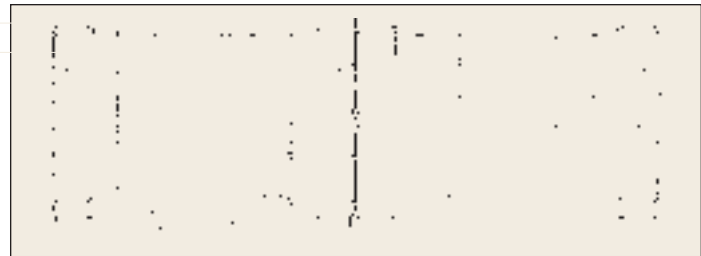

Double-Length System

Add track sets and mobile unit kits, refer to page 92.

See page 104-105 for Stationary Seismic shelving.

#### Notes:

- Floor anchors are not included. The structural engineer of record must verify that the anchorage bolt and building structure are adequate for the applied load.
- For OSHPD approval, the highest load shelf must be no more than 60" (1524mm) from the floor.
- For OSHPD approval, a unit must have no more than four loaded shelves within 60" (1524mm) height.
- If a fifth shelf is used, it must serve only as a cover and not be used for load bearing.
- According to the California State Fire Marshall, there must be a clearance of at least 18" (457mm) below sprinkler systems.
- Each shelving unit, whether single or "back-to-back" cannot connect to other shelving units or walls.



# METROMAX i® AND METROMAX Q® TOP-TRACK®



## MetroMax iQ™ Top-Track — 9.29

The system compensates for uneven floor surfaces. Floor should be smooth and free from large cracks or raised obstacles. Maximum load capacity for mobile units is 900 lbs. (400kg).

### Stationary End Unit Kit — Order one per Top-Track system.

- Includes hardware and components to connect track sets to two stationary end units. 86" (2185mm) posts included. Shelves are ordered separately (see pages 14 and 15).

Fits Shelf Width (in.)	Fits Shelf Width (mm)	i	Q
		Cat. No. End Unit Kit	Cat. No. End Unit Kit
18	457	<b>MXTTE18</b>	<b>MQTTE18</b>
21	530	—	<b>MQTTE21</b>
24	610	<b>MXTTE24</b>	<b>MQTTE24</b>

### Stationary Intermediate Unit Kit —

Required when the desired length of track exceeds 21' (6405mm).

- A stationary intermediate kit may be used at the discretion of the end user when track lengths are less than 21' (6405mm) to increase the overall rigidity of the system. Kit includes the hardware and components needed to connect track sets to one stationary intermediate unit. 86" (2185mm) posts included. Shelves are ordered separately (see pages 14 and 15).

Fits Shelf Width (in.)	Fits Shelf Width (mm)	i	Q
		Cat. No. Intermediate Unit Kit	Cat. No. Intermediate Unit Kit
18	457	<b>MXTTA18</b>	<b>MQTTA18</b>
21	530	—	<b>MQTTA21</b>
24	610	<b>MXTTA24</b>	<b>MQTTA24</b>

### Mobile Unit Kit — Order one per mobile unit.

- Kit includes posts, rigid casters, caster channels, bumpers, and roller assemblies. Shelves are sold separately.

Fits Shelf Width (in.)	Fits Shelf Width (mm)	i	i	Q	Q
		Cat. No. with Plated Casters	Cat. No. with Stainless Casters	Cat. No. with Plated Casters	Cat. No. with Stainless Casters
18	457	<b>MXTTM18C</b>	<b>MXTTM18S</b>	<b>MQTTM18C</b>	<b>MQTTM18S</b>
21	530	—	—	<b>MQTTM21C</b>	<b>MQTTM21S</b>
24	610	<b>MXTTM24C</b>	<b>MXTTM24S</b>	<b>MQTTM24C</b>	<b>MQTTM24S</b>

### Track Sets — One track set is required between stationary units

- Includes necessary sections of track for assembling track runs of 6' to 21' (1830-6405mm).

Length (feet)	Length (mm)	Approx. Pkd. Wt.		Cat. No.	Length (feet)	Length (mm)	Approx. Pkd. Wt.		Cat. No.
		(lbs.)	(kg)				(lbs.)	(kg)	
2½	762	15	6.8	<b>TTS2.5NA</b>	14	4267	98	44.1	<b>TTS14NA</b>
6	1828	40.5	18.2	<b>TTS6NA</b>	15	4572	106.5	47.9	<b>TTS15NA</b>
7	2135	47.5	21.3	<b>TTS7NA</b>	16	4877	113.5	51	<b>TTS16NA</b>
8	2440	56	25.2	<b>TTS8NA</b>	17	5182	121	54.4	<b>TTS17NA</b>
9	2743	62.5	28.1	<b>TTS9NA</b>	18	5486	128	51.6	<b>TTS18NA</b>
10	3048	69.5	31.2	<b>TTS10NA</b>	19	5791	135	60.7	<b>TTS19NA</b>
11	3353	76.5	34.4	<b>TTS11NA</b>	20	6096	142	63.9	<b>TTS20NA</b>
12	3657	83.5	37.5	<b>TTS12NA</b>	21	6400	149	67	<b>TTS21NA</b>
13	3962	92	41.4	<b>TTS13NA</b>					

Note: TTS2.5NA includes a joining kit to connect the tracks to longer track sections.

**Maximizes Storage Capacity:** Top-Track can increase the storage capacity of a given area by 30% to 40%. Put more storage units into a defined space. A movable, open aisle allows full access to each entire shelving unit—eliminating hard to reach or “dead” spaces.

**Easy Access:** The overhead track system guides the mobile units and opens an access aisle between any two units. The track is above the storage units enabling easy access.

**Clean Design:** Guide tracks are installed overhead enabling easy cleaning of floors. MetroMax i® and MetroMax Q shelves feature removable polymer shelf mats and built-in Microban antimicrobial product protection to promote easier routine cleaning.

**Uniquely Interchangeable:** Mix and match MetroMax i® and Q shelves and posts based on the application. Corrosion proof MetroMax i® offers solid shelf option and better chemical resistance. Corrosion resistant MetroMax Q steel posts can improve the overall rigidity of the Top-Track system in higher weight bearing applications.

### Configuration Guidelines

- Standard Top-Track models include 86" (2185mm) stationary posts and 74" (1880mm) stem caster mobile posts. If a taller system is required, consult Metro Engineering.
- Mobile, stationary end, and intermediate units must have a minimum of 4 shelves.
- Stationary Intermediate Unit is required when the track length exceeds 21' (6405mm). Intermediate kits include special support rails that attach to the overhead tracks on both sides of the intermediate unit. A stationary intermediate unit may be used at the discretion of the user when track lengths are less than 21' (6405mm) for the purpose of adding greater stability to the overall system.
- Mobile Units: If 18" (457mm) wide mobile units are planned, the maximum allowable size shelf is 60" (1524mm) long. If 18" (457mm) wide by 60" (1524mm) long mobile units are planned, a maximum of five 18" (457mm) mobile units are allowable between two stationary units. 18" (457mm), 21" (530mm) and 24" (610mm) wide mobile units can be intermixed in a given system. The standard system requires 74" (1880mm) posts on the mobile units. Recommended maximum load rating for a mobile unit is 900 lbs. (410kg).
- Under normal conditions, an aisle of 30" to 36" (760-914mm) is recommended. The storage of very large objects within the system, however, may require an aisle width larger than 36" (914mm).
- To accommodate bumpers, the actual size of a mobile unit is 2.5" (63.5mm) wider than the shelf width shown. For example, an 18" (457mm) wide unit is actually 20.5" (521mm).
- To calculate the overall length of a MetroMax i or MetroMax Q Top-Track System, add the following: Nominal track length + Nominal widths of each end unit + 2" (51mm).

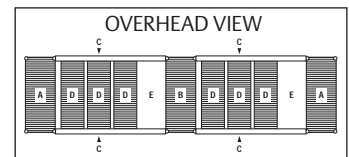
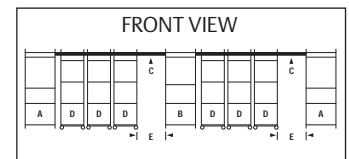

- A = Stationary End Units
- B = Stationary Intermediate Unit (Optional)
- C = Track Set
- D = Mobile Units
- E = Open Aisle

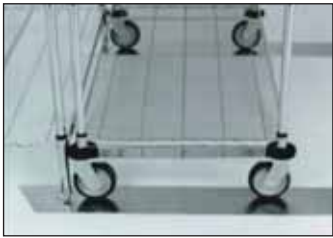

Top-Track® Floor Protectors

Top-Track® Floor Pad Protectors — **9.12** **11.12**

Use for both MetroMax Top-Track and Super Erecta Top-Track Systems.

For Track Length (in.)	For Track Length (mm)	Cat. No.
6	1.8	FPS6N
7	2.1	FPS7N
8	2.4	FPS8N
9	2.7	FPS9N
10	3	FPS10N
11	3.3	FPS11N
12	3.6	FPS12N
13	3.9	FPS13N

For Track Length (in.)	For Track Length (mm)	Cat. No.
14	4.2	FPS14N
15	4.6	FPS15N
16	4.9	FPS16N
17	5.2	FPS17N
18	5.5	FPS18N
19	5.8	FPS19N
20	6.1	FPS20N
21	6.4	FPS21N



Top-Track® Wall Mount Bracket

Top-Track® Wall Mount Bracket — **11.12**

Used to attach one set of tracks to the wall. Eliminates the need for a stationary end unit. Includes one pair of wall brackets and hardware to attach tracks to the wall brackets. Hardware to attach the wall brackets to the wall is NOT included.

Cat. No. **TTWM**



Top-Track® Stop Plate Kit

Top-Track® Stop Plate Kit — **11.12**

Used in conjunction with the Wall Mount Bracket Kit. The stop plates bolt to the underside of the track next to the wall brackets to prevent the mobile units from bumping into the wall.

Cat. No. **TTSTP**

**Metro Tip:**

Floor pad protectors compensate for soft flooring materials by protecting the floor from wear and tear. For new construction projects, it is recommended that flooring of suitable durability is used in areas where Top-Track will be installed.

Super Erecta® Hi-Rise Shelving — **10.17**

- For light-duty storage applications where floor space is at a premium.
- Construct shelving up to 24 feet (7315mm) high — 3 times the height of conventional shelving
- Metro's computerized engineering system assures correct specifications and load rating of Hi-Rise materials for your application.

All Hi-Rise installations must be reviewed and approved by Metro Engineering. Hi-Rise certification plate supplied. Only Super Erecta and Super Adjustable Super Erecta wire shelves (found on pages 37 and 42) can be used in Hi-Rise applications. Contact Metro customer service or your local Metro representative for details.

Material part numbers will be provided by Metro Product Development upon review of application.

**Metro Tip:**

One frequently overlooked opportunity to gain additional storage capacity is the efficient use of vertical space. By connecting Super Erecta posts, storage areas may be created that utilize every available cubic foot of unused vertical air space.



Super Erecta Hi-Rise Shelving



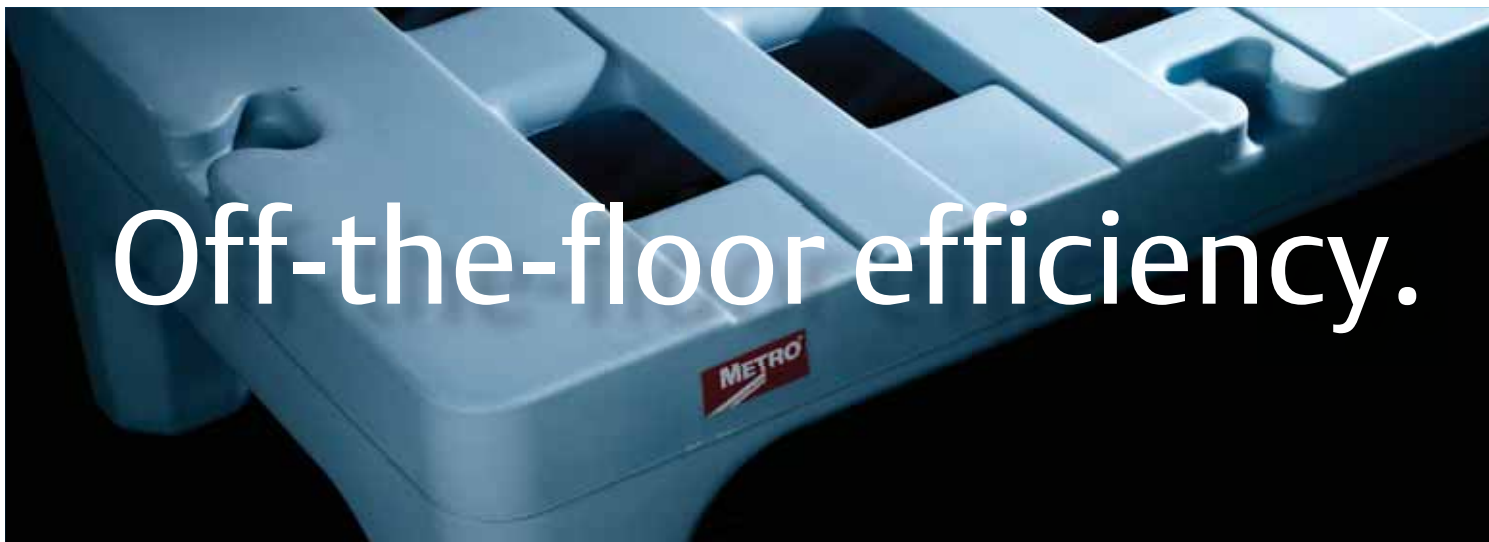

**Bow-Tie™ Dunnage Racks — 9.09**

12" (305mm) high; 22" (559mm) wide.

- Metro Bow-Tie Dunnage Racks are available with built-in Microban® antimicrobial product protection to protect from bacteria, mold, mildew and fungi that cause odors, stains and product degradation. Standard models, without Microban, are also available.
- Rust and corrosion-proof polymer material.
- Helps protect floors: legs have a larger radius than traditional dunnage racks and distribute the storage load across a wider area.
- Racks join together easily without tools in “end-to-end” and “back-to-back” configurations with the exclusive Bow-Tie™ feature.
- Heavy-duty construction gives racks the strength to hold up to 1,500 lbs. (683kg) for 30" (760mm) and 36" (914mm) long racks, and 3,000 (1365kg) for 48" (1219mm) and 60" (1524mm) racks.



**Microban**  
antimicrobial product protection  
Bow-Tie Dunnage Rack



Standard racks joined in “end-to-end” configuration.

Length (in.) (mm)	Height (in.) (mm)	Approx. Pkd. Wt.		Capacity		Cat. No. Microban®	Cat. No. Standard
		(lbs.)	(kg)	(lbs.)	(kg)		
30	760	12	305	24	10.8	1500 68	HP2230PDMB HP2230PD
36	914	12	305	26	11.7	1500 68	HP2236PDMB HP2236PD
48	1219	12	305	34	15.3	3000 136	HP2248PDMB HP2248PD
60	1524	12	305	42	19	3000 136	HP2260PDMB HP2260PD

☑ Indicates antimicrobial product.

## Dunnage Platforms (Standard Duty) — 10.44

Space-saving platforms let you keep bulky items off the floor.

- Open wire provides air circulation and minimizes dust.
- All platforms use 13P or 13PS posts — height 14<sup>5</sup>/<sub>8</sub>" (371mm) including cap and leveling bolt.



Super Erecta Platform

Width/Length (in./mm)		Approx. Pkd. Wt. (lbs./kg)		Cat. No. Super Erecta Brite	Cat. No. Chrome	Cat. No. Stainless
18x24	457x610	11	5.0	P1824BR	P1824NC	P1824NS
18x30	457x760	12	5.5	P1830BR	P1830NC	P1830NS
18x36	457x914	13 <sup>1</sup> / <sub>2</sub>	6.1	P1836BR	P1836NC	P1836NS
21x24	530x610	12	5.5	P2124BR	P2124NC	P2124NS
21x30	530x760	13	5.9	P2130BR	P2130NC	P2130NS
21x36	530x914	15	6.8	P2136BR	P2136NC	P2136NS
24x24	610x610	13	5.9	P2424BR	P2424NC	P2424NS
24x30	610x760	15	6.8	P2430BR	P2430NC	P2430NS
24x36	610x914	17	7.7	P2436BR	P2436NC	P2436NS

## Heavy-Duty Dunnage Racks — 10.46

A space-efficient way to store large, bulky items off the floor.

- Removable top mat lifts off for cleaning.
- Dunnage racks are 14<sup>1</sup>/<sub>2</sub>" (368mm) high including mat, cap and leveling bolt.



Dunnage Rack with Mat

Width/Length (in./mm)		Approx. Pkd. Wt. (lbs./kg)		Cat. No. Chrome	Cat. No. Metroseal 3 with Microban®	Cat. No. Stainless
18x24	457x610	22	10	HP31C	HP31K3	
18x30	457x760	25	11	HP32C	HP32K3	
18x36	457x914	30	13	HP33C	HP33K3	HP33S
18x48	457x1219	38	17	HP35C*	HP35K3*	HP35S*
24x24	610x610	28	12	HP51C	HP51K3	
24x30	610x760	30	14	HP52C	HP52K3	
24x36	610x914	36	16	HP53C	HP53K3	HP53S
24x48	610x1219	42	19	HP55C*	HP55K3*	HP55S*

**Note:** Maximum distributed static load capacity for stationary dunnage racks is 1,600 lbs. (725kg), except on units marked \* which have a 1,300 lb. (590kg) capacity.

## Mobile Dunnage Racks (Heavy Duty) — 10.46

These easy-to-manuever racks feature two swivel and two swivel/brake casters; with non-marking polyurethane tread.

- Support frames: 1" (25mm) square tubing.
- Removable wire mat: 5<sup>1</sup>/<sub>16</sub>" (7.9mm) diameter wire.



Mobile Dunnage Rack shown in Metroseal 3 finish

Width/Length (in./mm)		Approx. Pkd. Wt. (lbs./kg)		Cat. No. Chrome	Cat. No. Metroseal 3 with Microban®	Cat. No. Stainless
18x36	457x914	42	18.9	MHP33C	MHP33K3	MHP33S
18x48	457x1219	50	22.5	MHP35C	MHP35K3	MHP35S
24x36	610x914	48	21.6	MHP53C	MHP53K3	MHP53S
24x48	610x1219	54	24.3	MHP55C	MHP55K3	MHP55S

Maximum distributed static load capacity is 800 lbs. (363kg).

**Note:** These units are designed for only the 5HP and 5HPB casters, which are shipped assembled with the special posts.

## HD Super Duty Dunnage Racks — 10.68

Stores more than a ton safely off the floor.

- 48" (1219mm) rack has a 3,000 pound (1361kg) static load capacity (uniformly distributed); 60" (1524mm) rack carries up to 2,400 pounds (1089kg).
- HD Super™ design features fast, secure assembly without tools.
- Posts of 1<sup>5</sup>/<sub>8</sub>" (41mm) diameter provide greater rigidity.
- HD Super™ Dunnage Racks are 16<sup>1</sup>/<sub>4</sub>" (413mm) high including cap and leveling bolt.



HD Super Dunnage Rack

Width/Length (in./mm)		Approx. Pkd. Wt. (lbs./kg)		Cat. No. Chrome	Cat. No. Metroseal 3 with Microban®	Cat. No. Stainless
18x48	457x1219	52	23.4	HDP35C	HDP35K3	HDP35S
18x60	457x1524	62	27.9	HDP36C	HDP36K3	HDP36S
24x48	610x1219	57	26.6	HDP55C	HDP55K3	HDP55S
24x60	610x1524	66	29.7	HDP56C	HDP56K3	HDP56S

Maximum capacity 2,400 pounds (1089kg) uniformly distributed static load on the 60" (1524mm) length racks; 3,000 pounds (1361kg) on the 48" (1219mm) length racks.

**Note:** Capacity will be reduced and the unit will become less stable if the 3-sided frame is mounted higher than 6" (152mm) from the floor.



Indicates antimicrobial product.



# Keep out!

## Security Units

Protect valuable materials and sensitive items from loss or pilferage.

- Ready View of Contents: Heavy-gauge open wire construction keeps contents visible at all times, making it easy to check inventory.
- Optional Adjustable Intermediate Shelves: Patented easily adjustable shelf designs — Super Adjustable Super Erecta, MetroMax Q, and quikSLOT — allow flexibility to meet changing needs. Can be positioned in 1" (25mm) increments along the entire height of post.
- Double Door: Each door opens 270 degrees and can be secured along the sides of the unit.
- Shipped Knocked-Down: Saves on freight costs. Easily assembled.











MetroMax Q Security Unit



Super Adjustable Super Erecta Security Unit

## Ordering Guide for Security Units

	DRY ENVIRONMENTS		WET ENVIRONMENTS		
1) Choose the right finish and shelving style based on the usage environment and/or cleaning methods.	Super Erecta Chrome Finish	quikSLOT Chrome Finish	Super Erecta Metroseal 3 Finish	MetroMax Q Polymer & Epoxy Coated Steel Finish	Super Erecta Type 304 Stainless Steel Finish
Corrosion protection	N/A	N/A	Corrosion Resistant	Corrosion Resistant	Corrosion Proof
NSF Listed	YES	NO	YES	YES	YES
2) Choose from Stationary and Mobile Options.					
Stationary	8 Models	5 Models	5 Models	3 Models	8 Models
Mobile: Medium-Duty Recommended security models with stem casters.	 DC & EC Models Include casters with zinc-plated horns	 DCQ & ECQ Models Include casters with zinc-plated horns	 VK3 Models Include casters with polymer horns	 VE Models Include casters with polymer horns	Casters are NOT provided with Stainless Steel Standard-Duty Stem Caster base models. Casters are sold separately for "SD" models.
Mobile: Heavy-Duty applications are best addressed by carts with dolly bases. Recommended when the cart will frequently be moved long distances, over doorways and thresholds, or between facilities or buildings. NOTE: Super Erecta security units are most often selected for these applications.	 Dollies/casters included LC Models	 Dollies/casters included LCQ Models	 Dollies/casters included LK3 Models	 Dollies/casters included LE Models	Dollies and plate casters are NOT provided with the Heavy-Duty Stainless Steel base models. Dollies & plate casters are ordered separately S-HD Models
3) Select Intermediate Shelves.	Intermediate shelves are not included with base models.				



SEC55C shown with optional Super Adjustable intermediate shelves.

**Super Erecta® Shelf Stationary Security — 66<sup>13</sup>/<sub>16</sub>" (1695mm) high**  
 Intermediate shelves are not included with base models and must be ordered separately. See page 101 for intermediate shelf options.

Width (in.)	(mm)	Length (in.)	(mm)	Fits Shelf		Approx. Pkd. Wt. (lbs.) (kg)	Cat. No. Chrome	Cat. No. Metroseal 3 with Microban®	Cat. No. Stainless Steel
				(in.)	(mm)				
21 <sup>1</sup> / <sub>2</sub>	546	38 <sup>1</sup> / <sub>2</sub>	980	18x36	457x914	138 63	SEC33C	SEC33K3	SEC33S
21 <sup>1</sup> / <sub>2</sub>	546	50 <sup>1</sup> / <sub>2</sub>	1295	18x48	457x1219	157 71	SEC35C	SEC35K3	SEC35S
27 <sup>1</sup> / <sub>4</sub>	692	38 <sup>1</sup> / <sub>2</sub>	980	24x36	610x914	154 70	SEC53C	SEC53K3	SEC53S
27 <sup>1</sup> / <sub>4</sub>	692	50 <sup>1</sup> / <sub>2</sub>	1295	24x48	610x1219	174 79	SEC55C	SEC55K3	SEC55S
27 <sup>1</sup> / <sub>4</sub>	692	62 <sup>1</sup> / <sub>2</sub>	1587	24x60	610x1524	195 89	SEC56C	SEC56K3	SEC56S
33 <sup>1</sup> / <sub>2</sub>	851	38 <sup>1</sup> / <sub>2</sub>	980	30x36	760x914	167 76	SEC63C		SEC63S
33 <sup>1</sup> / <sub>2</sub>	851	50 <sup>1</sup> / <sub>2</sub>	1295	30x48	760x1219	193 88	SEC65C		SEC65S
33 <sup>1</sup> / <sub>2</sub>	851	62 <sup>1</sup> / <sub>2</sub>	1587	30x60	760x1524	215 98	SEC66C		SEC66S



SEC55DC shown with optional Super Adjustable intermediate shelves (sold separately). Doors rotate 270° and can be secured to the sides of the cart while contents are being loaded on the shelves.

**Super Erecta® Mobile Security**

**Standard-Duty Stem Caster Models — Chrome and Metroseal 3**

Chrome and Metroseal 3 Standard-Duty Stem Caster Models include 5" (127mm) casters.

Intermediate shelves are not included with base models and must be ordered separately. See page 101 for intermediate shelf options.

Caster Type	Width (in.)	(mm)	Length (in.)	(mm)	Fits Shelf		Approx. Pkd. Wt. (lbs.) (kg)	Cat. No. Chrome	Cat. No. Metroseal 3 with Microban®
					(in.)	(mm)			
(2) 5MP/(2) 5MPB	21 <sup>1</sup> / <sub>2</sub>	546	40 <sup>3</sup> / <sub>4</sub>	1035	18x36	457x914	146 66	SEC33EC	SEC33EK3
(2) 5MP/(2) 5MPB	21 <sup>1</sup> / <sub>2</sub>	546	52 <sup>3</sup> / <sub>4</sub>	1340	18x48	457x1219	165 75	SEC35EC	SEC35EK3
(4) 5MP	27 <sup>1</sup> / <sub>4</sub>	692	40 <sup>3</sup> / <sub>4</sub>	1035	24x36	610x914	162 74	SEC53DC	SEC53DK3
(4) 5MP	27 <sup>1</sup> / <sub>4</sub>	692	52 <sup>3</sup> / <sub>4</sub>	1340	24x48	610x1219	182 83	SEC55DC	SEC55DK3
(4) 5MP	27 <sup>1</sup> / <sub>4</sub>	692	65	1651	24x60	610x1524	203 92	SEC56DC	SEC56DK3
(2) 5MP/5MPB	27 <sup>1</sup> / <sub>4</sub>	692	40 <sup>3</sup> / <sub>4</sub>	1035	24x36	610x914	162 74	SEC53EC	SEC53EK3
(2) 5MP/5MPB	27 <sup>1</sup> / <sub>4</sub>	692	52 <sup>3</sup> / <sub>4</sub>	1340	24x48	610x1219	182 83	SEC55EC	SEC55EK3
(2) 5MP/5MPB	27 <sup>1</sup> / <sub>4</sub>	692	65	1651	24x60	610x1524	203 92	SEC56EC	SEC56EK3
(2) 5PC/5PCB	27 <sup>1</sup> / <sub>4</sub>	692	40 <sup>3</sup> / <sub>4</sub>	1035	24x36	610x914	162 74		SEC53VK3
(2) 5PC/5PCB	27 <sup>1</sup> / <sub>4</sub>	692	52 <sup>3</sup> / <sub>4</sub>	1340	24x48	610x1219	182 83		SEC55VK3
(2) 5PC/5PCB	27 <sup>1</sup> / <sub>4</sub>	692	65	1651	24x60	610x1524	203 92		SEC56VK3
(2) 5MP/(2) 5MPB	33 <sup>1</sup> / <sub>2</sub>	851	40 <sup>3</sup> / <sub>4</sub>	1035	30x36	760x914	175 80	SEC63EC	
(2) 5MP/(2) 5MPB	33 <sup>1</sup> / <sub>2</sub>	851	52 <sup>3</sup> / <sub>4</sub>	1340	30x48	760x1219	202 92	SEC65EC	
(2) 5MP/(2) 5MPB	33 <sup>1</sup> / <sub>2</sub>	851	65	1651	30x60	760x1524	223 101	SEC66EC	

Casters: 5MP and 5MPB (with locking brake) feature a polyurethane tread. 5PC and 5PCB (with locking brake) casters feature a polymer horn and resist rusting. They are recommended for high-moisture environments. Large casters can create a tipping hazard. On security units using 18" (457mm) deep shelving, do not use casters larger than 5" (127mm) in diameter. Overall height: Models with 5MP casters — 67<sup>15</sup>/<sub>16</sub>" (1726mm) high. Models with 5PC casters — 68<sup>7</sup>/<sub>16</sub>" (1739mm) high.



SEC55LC shown with optional Super Adjustable intermediate shelves.

**Heavy-Duty Models — Chrome and Metroseal 3 — 68<sup>7</sup>/<sub>16</sub>" (1739mm) high**

Chrome and Metroseal 3 models feature aluminum dollies with wraparound bumpers and 5" (127mm) diameter casters.

Caster Type	Width (in.)	(mm)	Length (in.)	(mm)	Fits Shelf		Approx. Pkd. Wt. (lbs.) (kg)	Cat. No. Chrome	Cat. No. Metroseal 3 with Microban®
					(in.)	(mm)			
(2) B5P/B5PB	28 <sup>7</sup> / <sub>16</sub>	713	38 <sup>1</sup> / <sub>2</sub>	980	24x36	610x914	187 85	SEC53LC	SEC53LK3
(2) B5P/B5PB	28 <sup>7</sup> / <sub>16</sub>	713	50 <sup>1</sup> / <sub>2</sub>	1285	24x48	610x1219	210 95	SEC55LC	SEC55LK3
(2) B5P/B5PB	28 <sup>7</sup> / <sub>16</sub>	713	63 <sup>1</sup> / <sub>8</sub>	1600	24x60	610x1524	235 107	SEC56LC	SEC56LK3

✓ Indicates antimicrobial product.



### Standard-Duty Stem Caster Models — Stainless Steel — 62" (1575mm) high

Casters must be ordered separately. See pages 48-49, or consult your Metro representative for the proper caster for your application. Intermediate shelves are not included with base models and must be ordered separately.

Description	Width (in.) (mm)	Length (in.) (mm)	Fits Shelf (in.) (mm)		Approx. Pkd. Wt. (lbs.) (kg)		Cat. No. Stainless Steel
Standard Duty	21½ 546	40¾ 1035	18x36	457x914	138	63	SEC33S-SD
Standard Duty	21½ 546	52¾ 1340	18x48	457x1219	157	71	SEC35S-SD
Standard Duty	27¼ 692	40¾ 1035	24x36	610x914	154	70	SEC53S-SD
Standard Duty	27¼ 692	52¾ 1340	24x48	610x1219	174	79	SEC55S-SD
Standard Duty	27¼ 692	65 1651	24x60	610x1524	195	89	SEC56S-SD
Standard Duty	33½ 851	40¾ 1035	30x36	760x914	167	76	SEC63S-SD
Standard Duty	33½ 851	52¾ 1340	30x48	760x1219	193	88	SEC65S-SD
Standard Duty	33½ 851	65 1651	30x60	760x1524	215	98	SEC66S-SD

**Note:** Given height is for unit without casters. For approximate overall unit height add chosen caster diameter plus 1" (25mm).  
**Note:** Large casters can create a tipping hazard. On security units using 18" (457mm) deep shelving, do not use casters larger than 5" (127mm) in diameter.

**Metro Tip:**  
**Caster Selection:**  
 For highly corrosive environments, choose casters constructed of appropriate materials. While most wheels are corrosion resistant, the horns and axles are not. Select from a variety of Metro casters with polymer and stainless components. See pages 48-49 and 51 for more information.

### Heavy-Duty Models — Stainless Steel — 62" (1575mm) high

Heavy-duty stainless steel models include staked posts for use with standard Metro dollies. Dolly bases and plate casters must be ordered separately. See pages 50-52, or consult your Metro representative for the proper caster for your application. Intermediate shelves are not included with base models and must be ordered separately.

Description	Width (in.) (mm)	Length (in.) (mm)	Fits Shelf (in.) (mm)		Approx. Pkd. Wt. (lbs.) (kg)		Cat. No. Stainless Steel
Heavy Duty	28½ 713	38½ 980	24x36	610x914	154	70	SEC53S-HD
Heavy Duty	28½ 713	50½ 1285	24x48	610x1219	174	79	SEC55S-HD
Heavy Duty	28½ 713	63⅞ 1600	24x60	610x1524	195	89	SEC56S-HD

**Note:** Given height is for unit without a Metro dolly or casters.  
**Note:** To calculate the actual height of the unit using plate casters: 62" [1575mm] + ¼" [6mm] for dolly + load height of the caster (found on page 49).  
 Dolly bases are recommended for applications where security units will be transported over the road. Please consult your Metro representative for the appropriate casters and accessories for these applications.

### Intermediate Shelves for Super Erecta Shelf Security Units

Width (in.) (mm)	Length (in.) (mm)	Approx. Pkd. Wt. (lbs.) (kg)		Cat. No. Chrome	Cat. No. Metroseal 3 with Microban®	Cat. No. Stainless Steel	Cat. No. Super Erecta Pro
18	457	36	9¼ 4.3	A1836NC	A1836NK3	A1836NS	PR1836NK3
18	457	48	12 5.4	A1848NC	A1848NK3	A1848NS	PR1848NK3
24	610	36	13 6	A2436NC	A2436NK3	A2436NS	PR2436NK3
24	610	48	16 7	A2448NC	A2448NK3	A2448NS	PR2448NK3
24	610	60	21 9.5	A2460NC	A2460NK3	A2460NS	PR2460NK3
30	760	36	15 6.8	A3036NC		A3036NS	
30	760	48	21 9.5	A3048NC		A3048NS	
30	760	60	26½ 11.8	A3060NC		A3060NS	

**Note:** Standard Super Erecta shelves can also be used as intermediate shelves. Refer to page 42 for more information.

### Super Erecta Security Modules — 14.01

Convert a standard 24" (610mm) wide unit into a security module with this convenient kit.

- Used to enclose one or more areas of a unit.
- Fits between shelves spaced 20" (510mm) apart on any Super Erecta Shelving unit.
- Adapts to 24" (610mm) wide shelves in 30," 48" and 60" (760, 1219 and 1524mm) lengths.

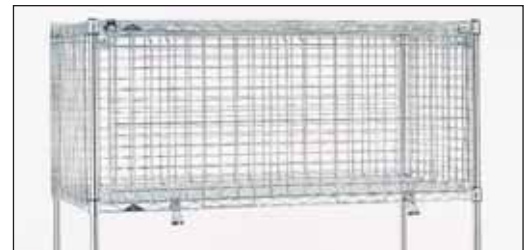

SECM2430NC  
Assembled on Shelving Unit

Width/Length (in.) (mm)	Height (in.) (mm)	Approx. Pkd. Wt. (lbs.) (kg)		Cat. No. Chrome	Cat. No. Stainless Steel
24x30 610x760	20 510	29¼ 14		SECM2430NC	SECM2430NS
24x48 610x1219	20 510	39¾ 18		SECM2448NC	*
24x60 610x1524	20 510	45¾ 21		SECM2460NC	*

**Note:** Security Module consists of side panels, back panels and door. Posts and shelves sold separately, see page 42.  
**When multiple security modules are stacked on one shelving unit, separate top and bottom shelves are still necessary for each module.**  
 Security modules must be used with Super Erecta Shelf wire shelves.



Ⓢ Indicates antimicrobial product.



SEC53DCQ shown with Intermediate Shelves (optional)

qwikSLOT™ Security Units — 14.01

- Add/Remove-A-Shelf Feature: Allows the unit to quickly adapt to your changing storage needs.
- Shelves can be adjusted easily in seconds.
- Each unit requires a standard Super Erecta shelf at the top and bottom (see page 42).

qwikSLOT Stationary Security

Caster Type	Width		Actual Length		Height		Fits Shelf		Approx. Pkd. Wt.		Cat. No. Chrome
	(in.)	(mm)	(in.)	(mm)	(in.)	(mm)	(in.)	(mm)	(lbs.)	(kg)	
	21 1/2	546	38 1/2	980	66 13/16	1695	18x36	457x914	138	63	SEC33CQ
	21 1/2	546	50 1/2	1283	66 13/16	1695	18x48	457x1219	157	71	SEC35CQ
	27 1/4	705	38 1/2	980	66 13/16	1695	24x36	610x914	154	70	SEC53CQ
	27 1/4	705	50 1/2	1283	66 13/16	1695	24x48	610x1219	174	79	SEC55CQ
	27 1/4	705	62 1/2	1587	66 13/16	1695	24x60	610x1524	195	89	SEC56CQ

qwikSLOT Mobile Security

Standard-Duty Stem Caster Models: feature 5" (127mm) swivel casters. Please note model numbers for specific caster types.

Caster Type	Width		Actual Length		Height		Fits Shelf		Approx. Pkd. Wt.		Cat. No. Chrome
	(in.)	(mm)	(in.)	(mm)	(in.)	(mm)	(in.)	(mm)	(lbs.)	(kg)	
(2) 5MP/5MPB	21 1/2	546	40 3/4	1035	67 15/16	1726	18x36	457x914	146	66	SEC33ECQ
(2) 5MP/5MPB	21 1/2	546	52 3/4	1340	67 15/16	1726	18x48	457x1219	165	75	SEC35ECQ
(4) 5MP	27 1/4	692	40 3/4	1035	67 15/16	1726	24x36	610x914	162	74	SEC53DCQ
(4) 5MP	27 1/4	692	52 3/4	1340	67 15/16	1726	24x48	610x1219	182	83	SEC55DCQ
(4) 5MP	27 1/4	692	65	1651	67 15/16	1726	24x60	610x1524	203	92	SEC56DCQ
(2) 5MP/5MPB	27 1/4	692	40 3/4	1035	67 15/16	1726	24x36	610x914	162	74	SEC53ECQ
(2) 5MP/5MPB	27 1/4	692	52 3/4	1340	67 15/16	1726	24x48	610x1219	182	83	SEC55ECQ
(2) 5MP/5MPB	27 1/4	692	65	1651	67 15/16	1726	24x60	610x1524	203	92	SEC56ECQ

Casters: 5MP and 5MPB (with locking brake) feature a polyurethane tread. 5PC and 5PCB (with locking brake) casters feature a polymer horn and resist rusting. They are recommended for high moisture environments. **NOTE:** Large casters can create a tipping hazard. On 18" (457mm) security units, do not use casters larger than 5" (127mm) in diameter.



Clips snap easily into slots along post length to support shelves.

Heavy-Duty Models: feature aluminum dollies with wraparound bumpers and 5" (127mm) diameter casters.

Caster Type	Width		Actual Length		Height		Fits Shelf		Approx. Pkd. Wt.		Cat. No. Chrome
	(in.)	(mm)	(in.)	(mm)	(in.)	(mm)	(in.)	(mm)	(lbs.)	(kg)	
(2) 5BP/5BPB	28 1/16	713	38 1/2	980	68 7/16	1739	24x36	610x914	187	85	SEC53LCQ
(2) 5BP/5BPB	28 1/16	713	50 1/2	1283	68 7/16	1739	24x48	610x1219	210	95	SEC55LCQ
(2) 5BP/5BPB	28 1/16	713	63 1/8	1600	68 7/16	1739	24x60	610x1524	235	107	SEC56LCQ



qwikSLOT Locking Clip Recommended for mobile applications. Must be used with 9985QS shelf clips. (Package of 4) Cat. No. 9985QSL

Intermediate Shelves for Super Erecta Shelf Security Units

Width (in.)	Length (mm)	Approx. Pkd. Wt.		Cat. No. Chrome
		(lbs.)	(kg)	
18	457	8 1/2	3.8	1836QBR
18	457	11 1/4	5.0	1848QBR*
24	610	13	6.0	2436QBR*
24	610	16	7.0	2448QBR*
24	610	21	9.5	2460QBR

\*Chrome qwikSLOT shelves available in sizes 18x36, 18x48, 24x36, and 24x48 (457x914, 457x1219, 610x914, 610x1219, and 610x1524).

\*\*Drop Mat qwikSLOT shelves with 1" (25mm) ledge also available in sizes 24x36, 24x48 (610x914, 610x1219).

# MetroMax iQ™ Storage System

# Security.

## MetroMax Q Security Units — 14.01

Protects valuable materials and sensitive items from loss or pilferage.

- Ready view of contents: Heavy gauge open wire construction keep contents visible at all times, making it easy to check inventory.
- Microban antimicrobial product protection is built into the enclosures, doors, handles, and shelves to keep the product “cleaner between cleanings.”
- Optional intermediate shelves: MetroMax Q quick adjust shelves or corrosion proof MetroMax i.
- Double door with ergonomic ¼-turn handle: Each door opens 270 degrees and can be secured along the sides of the unit.
- Shipped knocked down to save on freight costs. Assembles in minutes.



MQSEC53VE with optional intermediate shelves

## MetroMax Q Stationary Units — 66<sup>3</sup>/<sub>16</sub>" (1681mm) High

Actual Outside Dimensions				Fits Shelf		Approx. Pkd. Wt.		Cat. No.
Width (in.) (mm)	Length (in.) (mm)	(in.) (mm)	(in.) (mm)	(lbs.) (kg)	(lbs.) (kg)			
26 <sup>15</sup> / <sub>16</sub>	685	38 <sup>7</sup> / <sub>8</sub>	987	24x36	610x914	148	67	<b>MQSEC53E</b>
26 <sup>15</sup> / <sub>16</sub>	685	50 <sup>7</sup> / <sub>8</sub>	1292	24x48	610x1219	156	71	<b>MQSEC55E</b>
26 <sup>15</sup> / <sub>16</sub>	685	62 <sup>7</sup> / <sub>8</sub>	1597	24x60	610x1524	161	73	<b>MQSEC56E</b>

Note: Leveling foot on post can be adjusted up to 1" (25mm) to compensate for uneven floors.

Standard Units consist of top and bottom wire shelves, tri-lobal adapters, steel posts, wire enclosures, and doors. Casters are included with mobile units. Intermediate shelves are sold separately.

## MetroMax Q Stem Caster Mobile Units — 67<sup>13</sup>/<sub>16</sub>" (1723mm) High

Actual Outside Dimensions (including Bumpers and Handle)				Fits Shelf		Approx. Pkd. Wt.		Cat. No. Standard with four 5" (127mm) Diameter Swivel Casters	Cat. No. Resistant with four Polymer Casters (2 with brakes)
Width (in.) (mm)	Length (in.) (mm)	(in.) (mm)	(in.) (mm)	(in.) (mm)	(in.) (mm)	(lbs.) (kg)	(lbs.) (kg)		
27 <sup>13</sup> / <sub>16</sub>	707	40 <sup>3</sup> / <sub>4</sub>	1035	24x36	610x914	166	75	<b>MQSEC53DE</b>	<b>MQSEC53VE</b>
27 <sup>13</sup> / <sub>16</sub>	707	52 <sup>3</sup> / <sub>4</sub>	1340	24x48	610x1219	176	80	<b>MQSEC55DE</b>	<b>MQSEC55VE</b>
27 <sup>13</sup> / <sub>16</sub>	707	64 <sup>3</sup> / <sub>4</sub>	1645	24x60	610x1524	179	81	<b>MQSEC56DE</b>	<b>MQSEC56VE</b>

\*\*"DE" models use four 5MP casters.

\*\*\*"VE" models use two 5PCX and two 5PCBX casters.



Ergonomic — ¼ turn door handle

## MetroMax Q Heavy-Duty Mobile Units — 68<sup>1</sup>/<sub>2</sub>" (1740mm) High

Mounted on aluminum dolly with 5" (127mm) plate casters and wraparound bumpers.

Actual Outside Dimensions (including Handle)				Fits Shelf		Approx. Pkd. Wt.		Cat. No.
Width (in.) (mm)	Length (in.) (mm)	(in.) (mm)	(in.) (mm)	(in.) (mm)	(in.) (mm)	(lbs.) (kg)	(lbs.) (kg)	
28 <sup>1</sup> / <sub>16</sub>	713	39 <sup>1</sup> / <sub>8</sub>	994	24x36	610x914	166	75	<b>MQSEC53LE</b>
28 <sup>1</sup> / <sub>16</sub>	713	51 <sup>1</sup> / <sub>8</sub>	1299	24x48	610x1219	176	80	<b>MQSEC55LE</b>
28 <sup>1</sup> / <sub>16</sub>	713	63 <sup>1</sup> / <sub>8</sub>	1603	24x60	610x1524	179	81	<b>MQSEC56LE</b>

Note: The aluminum dollies used on the LE models have two B5P and two B5PB plate casters.

## Intermediate Shelves

Width (in.) (mm)	Length (in.) (mm)	i		Q		
		Cat. No. Shelf with Grid Mat	Cat. No. Shelf with Solid Mat	Cat. No. Shelf with Grid Mat		
24	610	36	914	<b>MX2436G</b>	<b>MX2436F</b>	<b>MQ2436G</b>
24	610	48	1220	<b>MX2448G</b>	<b>MX2448F</b>	<b>MQ2448G</b>
24	610	60	1524	<b>MX2460G</b>	<b>MX2460F</b>	<b>MQ2460G</b>

Seismic Approved Shelving Systems

Super Erecta® (SES), Super Adjustable Super Erecta® (SASE), qwikSLOT™ (QS), HD Super (HD), MetroMax Q® (Q)

OSHDP Preapproved Bolt Plates Kits:

For 1" (25mm) diameter, Super Erecta Shelf, Super Adjustable Super Erecta, qwikSLOT stationary post assemblies. Kit includes plate assemblies and hardware to mount plates to posts. Floor anchors are not included.

Description	Qty.	Dimensions (Width/Length/Height)		Cat. No.
		(in.)	(mm)	
One-Post Bolt Plate, 1/4" (6mm)	4	27/8x7x1/4	73x178x6	SASES25BP-1
Two-Post Bolt Plate, 1/4" (6mm)	2	27/8x11x1/4	73x279x6	SASES25BP-2
Four-Post Bolt Plate, 1/4" (6mm)	1	27/8x11x1/4	73x279x6	SASES25BP-4
One-Post Bolt Plate, 1/2" (13mm)	4	7x7x1/2	178x178x13	SASES50BP-1
Two-Post Bolt Plate, 1/2" (13mm)	2	7x12x1/2	178x305x13	SASES50BP-2
Four-Post Bolt Plate, 1/2" (13mm)	1	7x12x1/2	178x305x13	SASES50BP-4

For 1.5" (38mm) diameter HD and trilobal Q stationary post assemblies. Kit includes plates and hardware to mount plates to posts. Floor anchors are not included.

Description	Qty.	Dimensions (Width/Length/Height)		Cat. No.
		(in.)	(mm)	
One-Post Bolt Plate, 1/4" (6mm)	4	27/8x7x1/4	73x178x6	SAQHD25BP-1
Two-Post Bolt Plate, 1/4" (6mm)	2	27/8x11x1/4	73x279x6	SAQHD25BP-2
Four-Post Bolt Plate, 1/4" (6mm)	1	27/8x11x1/4	73x279x6	SAQHD25BP-4
One-Post Bolt Plate, 1/2" (13mm)	4	7x7x1/2	178x178x13	SAQHD50BP-1
Two-Post Bolt Plate, 1/2" (13mm)	2	7x12x1/2	178x305x13	SAQHD50BP-2
Four-Post Bolt Plate, 1/2" (13mm)	1	7x12x1/2	178x305x13	SAQHD50BP-4

Approved

Fixed Equipment Anchorage California Office of Statewide Health Planning and Development OPA-0556

Required Components:

To meet requirements for preapproval, simply add floor bolt-plates to standard Metro stationary shelving configurations and follow the installation and usage guidelines. Just add floor plates

Example A  
Requires one 1-post starter kit. (ie. SASES25BP-1).

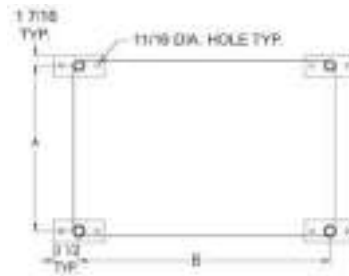

Example B  
Requires one starter kit, (ie. SASES25BP-1) and one 2-post adder kit, (ie. SASES25BP-2). Include one additional adder kit for each subsequent shelving unit added to the run.

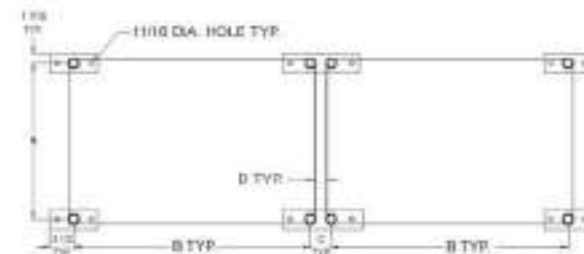

Example C  
Requires one 1-post starter kit, (ie. SASES25BP-1), two 2-post adder kits (ie. SASES25BP-2), and one 4-post adder kit, (ie. SASES25BP-4). Include one of each adder kit, (ie. one 2-post kit and one 4-post kit), for each additional pair of shelving units.

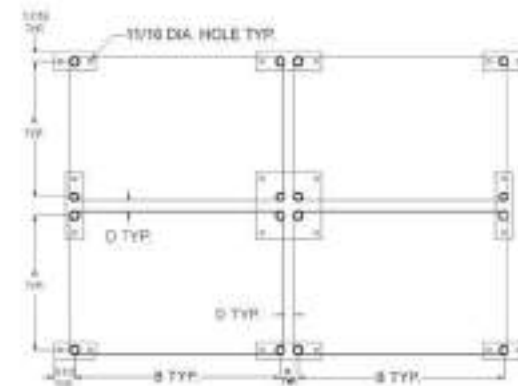



Super Adjustable Super Erecta, Super Erecta®, qwikSLOT™

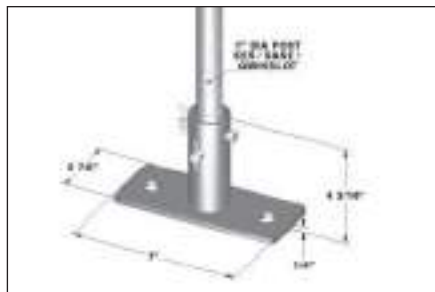

SASES25BP-1



SASES25BP-2

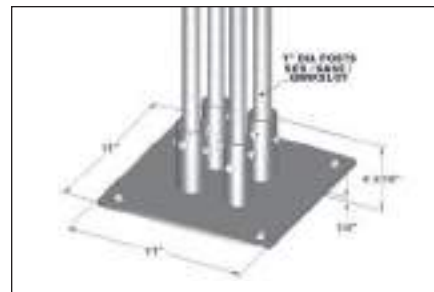

SASES25BP-4



SASES50BP-1



SASES50BP-2

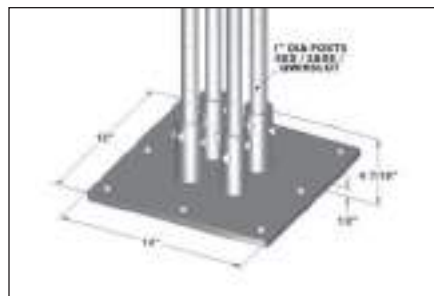

SASES50BP-4

Hint: It is recommended that a donut bumper be specified to cover any spaces between the post and the bolt plate anchor pipe. Specify the donut bumper to match the post type.



Super Erecta, Super Adjustable Super Erecta, qwikSLOT = 9992DB  
 Super Erecta Shelf HD = 9992H  
 MetroMax Q = 9992DBX

MetroMax Q®/HD Super



SAQHDS25BP-1



SAQHD25BP-2

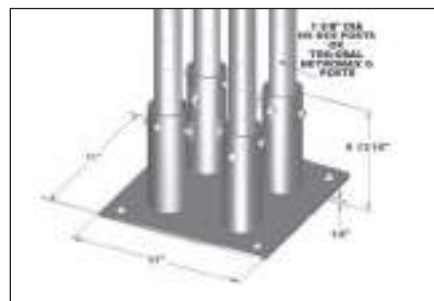

SAQHD25BP-4



SAQHD50BP-1



SAQHD50BP-2



SAQHD50BP-4

“YOU CAN DO IT...  
Visit us online and take  
advantage of our easy-to-use  
self-service tools.”



Self-service Tools Available...online!

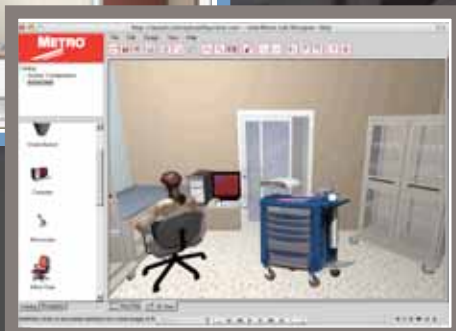
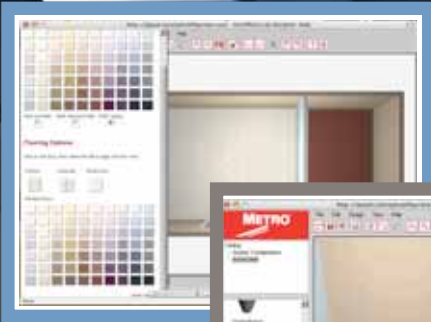

- Web-based Room Layout and Product Planning
- Web-based Product Configuration
- Web-based Learning Modules

[metroconfigurator.com](http://metroconfigurator.com)



Visit [metroconfigurator.com](http://metroconfigurator.com) and test drive the Configurator...our web based software developed to give you the power to manage your space.

# CONTENTS

## **Municipal Services Products ..... 107-112**

Turn-out Gear/General Storage and Security .....	110
Sanitation & Electronic Charging Stations.....	111
Evidence & Property Storage .....	112

## **Grocery & Retail Products ..... 114-140**

Display Shelving & Accessories .....	117-129
Specialty Shelving .....	130-132
Food Prep.....	133-136
Inventory Storage & Transport.....	137-138
Cooler/Freezer Storage.....	139-140

## **Electronics & Clean Room Products ..... 142-163**

Carts, Covers & ESD Accessories .....	144-149
PCB Handling .....	150-155
Tote Boxes, Bins & Accessories.....	156-157
Clean Tables, Carts & Gowning Room Products .....	158-163

## **Laboratory Products ..... 164-227**

Lab Carts & Storage .....	166-180
Autoclave Storage & Carts.....	181-183
LAR Feed Carts & Storage .....	184-185
Lab Worktables & Accessories .....	186-194
Mobile Computing WorkCenters .....	195
Portable Power Module/Units .....	196-197
Starsys Lab Furniture .....	198-227

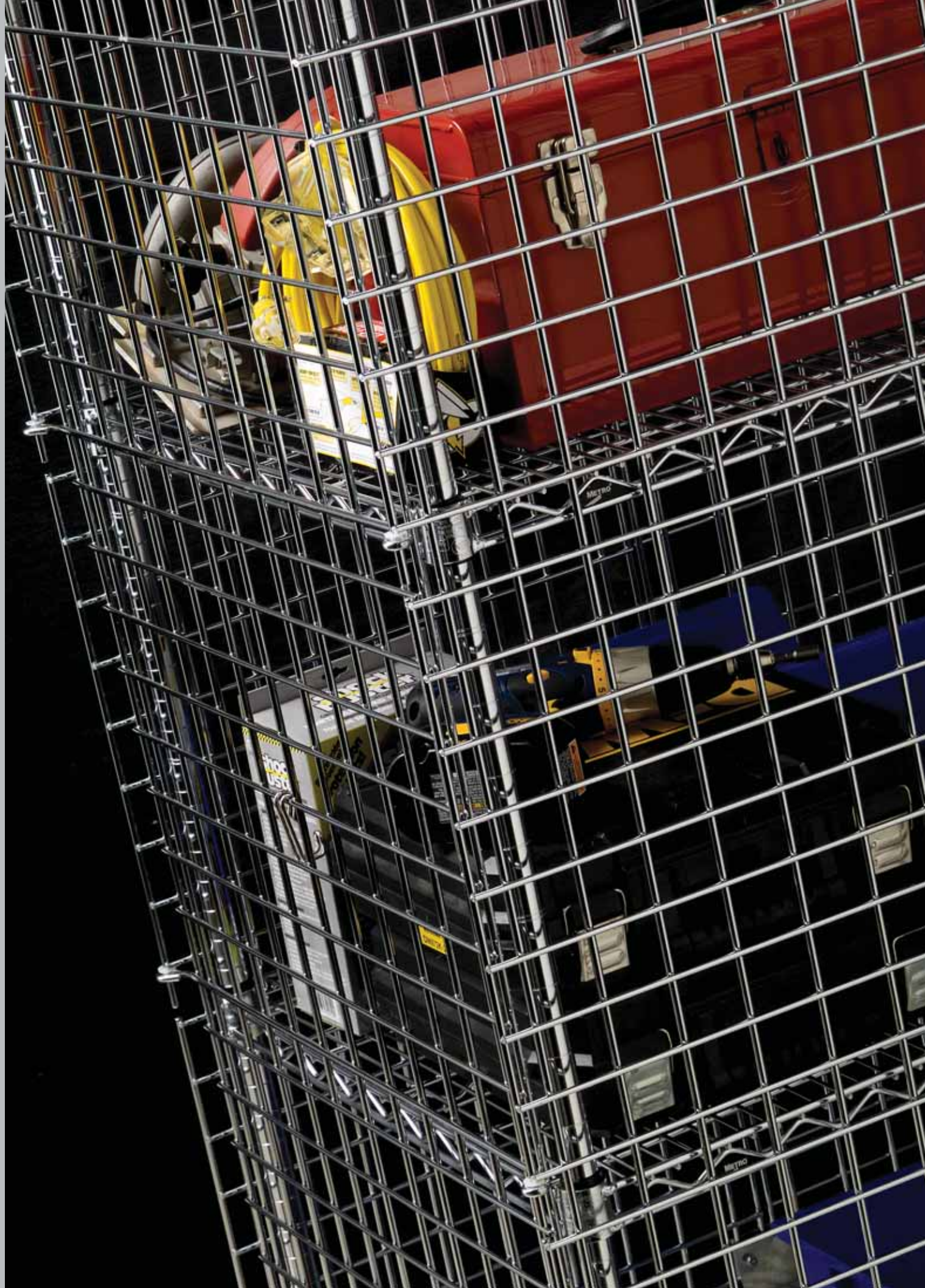

# MUNICIPAL SERVICES PRODUCTS

Turn-out Gear/General Storage and Security .....	110
Sanitation & Electronic Charging Stations.....	111
Evidence & Property Storage .....	112

### Turn-Out Gear Racks

Metro's Super Adjustable™ Super Erecta shelving can be customized to meet your exact needs.

The following standard components may be combined to create the Turn-Out Gear Rack (shown below) in Metroseal 3, Metro's patented corrosion-resistant finish. Metroseal 3 is warranted for 12 years against rust and corrosion and is manufactured with Microban®\* antimicrobial product protection built in. Other sizes and options available, consult your Metro representative.



Free-Standing System

- 4 74UPK3 Mobile Posts
- 3 A2472NK3 Super Adjustable™ Shelves in Metroseal 3 finish
- 2 5MP Swivel Casters (optional)
- 2 5MPB Swivel/Brake Casters (optional)
- 6 DD24K3 Dividers, in Metroseal 3 finish (used to create individual compartments)
- 1 DD2435D 72" (1829mm) Stainless Steel Hanger Tube
- 5 CC5923 Gear Hangers, Stainless Steel finish, closed top loop

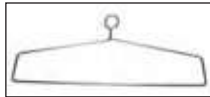

#### Metro Tip:

When planning Turn-Out Gear Racks, use shelving that is 24" (610mm) wide to best accommodate turn-out gear.



Wall Mounted System

- Open wire design promotes air circulation and light penetration for quicker drying of gear.
- Free-standing and wall-mounted units available.
- Two finishes available: durable chrome-plated, or patented Metroseal 3 (NK3) which carries a 12-year warranty against rust and corrosion, and offers Microban antimicrobial product protection. (See pages 37 and 42.)
- Stainless steel and chrome-plated gear hanging tube and hangers available
- Optional shelf dividers and label holders can be used to create individual compartments.



### General Storage



Super Adjustable™ Super Erecta® All-Purpose Storage (See page 37)

### Security Units



To keep gear, communication devices, etc. safe and secure. (See Pages 99-102)

\*Microban inhibits the growth of mold, mildew and bacteria.

## Sanitation/Decontamination Stations

### Sanitization Supply Storage

- Economical storage rack perfect for storing supplies over sinks or above work areas.
- Numerous sizes, styles and finishes available.

(See Wall Shelving page 78)



### Sanitization Supply/Task Station

Metro's SmartWall G3™ is a wall mount system of interchangeable components that allow customization of a sanitization area.

- Shelves, grids and accessories are easily attached where needed, keeping supplies within arm's reach.
- The wall track's smooth surface can be quickly wiped clean. Shelves and grids can be easily removed for cleaning and to clean the walls.
- Shown in Metroseal 3™, Metro's patented corrosion-resistant finish with Microban antimicrobial product protection. Metroseal 3 has a 12-year warranty against rust and corrosion.

(See pages 72-77)



## Electronic Equipment Charging Stations



Desktop and Free-Standing Units Available. (See "Solid Shelving" page 64)

\*Microban inhibits the growth of mold, mildew and bacteria.

### Evidence and Property Storage

Keep evidence and property safe, secure and organized with Metro’s high-density active aisle storage systems. Available in a variety of sizes and finishes, including corrosion-proof materials.

(See pages 88-96)



High-Density qwikTRAK Storage System  
(See pages 88, 90-91)



(Shown with optional accessories)

#### MetroMax i® Storage System

- Ideal for refrigerated storage.
- Corrosion and rust proof — lifetime warranty.
- Easily cleanable — lift off shelf mats are sized to fit utility sinks.
- Microban®\* antimicrobial product protection is built-in, inhibiting the growth of mold, mildew and bacteria.

(See pages 10-28)



#### Metro® Totes and Storage Bins

- Perfect for storing small items.
- Optional accessories include dividers, lids and label holders.

(See pages 156-157)

\*Microban inhibits the growth of mold, mildew and bacteria.





*Order today! Log on to*

***www.metro.com***

*locate a sales representative near you.*



*Not in the USA?* Look on the back cover  
of your catalog for the contact information you need.

“Let us make your  
next purchase easy,  
contact your  
representative today.”



# GROCERY & RETAIL PRODUCTS

Display Shelving & Accessories .....	117-129
Specialty Shelving .....	130-132
Food Prep.....	133-136
Inventory Storage & Transport.....	137-138
Cooler/Freezer Storage.....	139-140



# Visit us at www.metro.com/grocerysolutions



## Metro® has the perfect solution for every department in your supermarket

From the grocery aisles where we enhance your profits by increasing your shelving holding power by up to 30%; to your food storage and prep areas where Metro® offers productivity enhancing solutions; to your cooler/freezers where we assist your food safety program with easily cleanable, antimicrobial protected storage options, Metro offers innovative solutions to keep your store running smoothly and your customers happy. Simply click on a department below to review product or take a Virtual Store Tour to see how Metro puts space to work for you.

For more detailed information or to locate your nearest Metro representative, click on one of the links on the right.

Welcome and come explore what Metro can do for you.

[CLICK HERE for the NEW Grocery Solutions Brochure!](#)



- [Drop Mat Display Shelving Case Studies ▼](#)
- [Drop Mat Display Shelving Demo Video](#)
- [Store-Within A Store Merchandising Research ▼](#)
- [Food Safety at the Store Level ▼](#)
- [Metro Solutions in Action Around the World ▼](#)
- [Brochures ▼](#)
- [Product Spec Sheets ▼](#)
- [Color & Finish Options](#)
- [Metro Shelving Cleaning Guide](#)
- [Metro Food Storage Safety Tips](#)
- [Metro and the Environment](#)
- [Metro Rep Locator \(Choose Commercial\)](#)
- [What's New](#)
- [Complete Metro Catalog](#)

## Merchandising Solutions from Metro!

Genuine Metro . . . The Look That Sells!

- Increase profitability of the center store.
- Increase productivity in all prep and service areas.
- Improve food safety and storage optimization.



Metro Display Systems . . . The look that sells for mass merchandisers and supermarkets alike.



Metro's qwikSLOT™ display system highlights merchandise so customers notice. Create your own Store-Within-A-Store . . . a proven, effective sales and profit enhancing strategy.



Metro Drop Mat™ Display System . . . Increase unit capacity by up to 30%.

### What's the secret to increasing unit capacity?

- The secret to Metro's space-saving advantage is Drop Mat's "thin shelf" design ( $\frac{1}{4}$ " versus  $1\frac{1}{2}$ ""). DropMat eliminates the need for space robbing under-shelf supports and bulky shelf brackets, reclaiming 20% of your merchandising space.
- Back-to-back, DropMat saves yet more space. Reclaim up to 10% additional space by eliminating traditional gondola's 4" wide center support structure.

**Metro Tip:** Visit [metro.com/groceriesolutions](http://metro.com/groceriesolutions) and click on the link for Drop Mat case studies to review plannogram data demonstrating Drop Mat's increased holding power.



qwikSLOT™ — Metro qwikSLOT shelving adjusts in seconds to adapt to your changing merchandising needs. It provides a “clean,” unobstructed view of merchandise.



Super Erecta® — At 800 lbs. (363kg) per shelf weight capacity, Super Erecta Shelving and Super Adjustable Super Erecta wire shelving can handle heavy merchandise . . . and display it with Style!



Metro’s designer color shelving and flexible configurations adapt to suit any décor or retail theme.

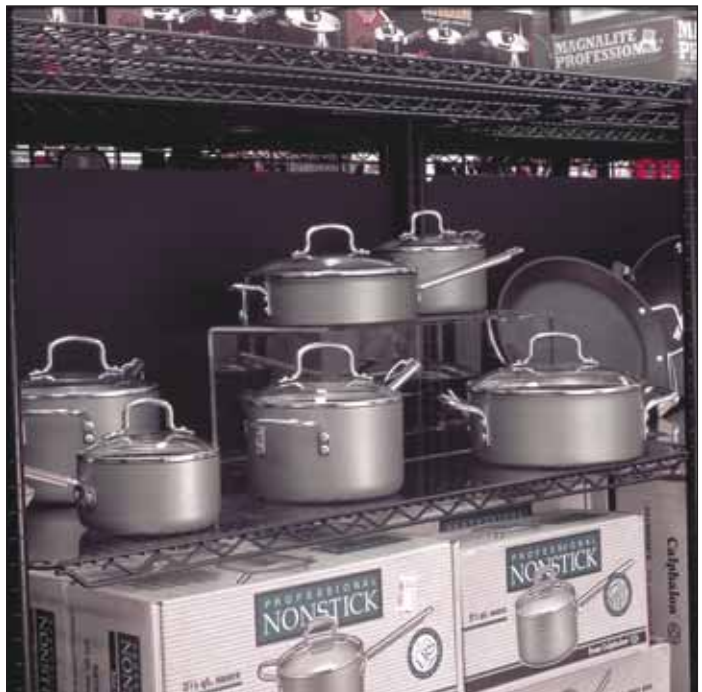



## Super Adjustable Super Erecta® Shelving

### Metroseal 3

- Corrosion Resistant — 12 year warranty against rust and corrosion.
- Unique Shelf Design: Super Adjustable™ offers the patented shelf release lever for fast and easy shelf adjustment at 1" (25mm) increments.
- Microban® antimicrobial product protection built-in.

See pages 36-39



## **NEW** Super Erecta Pro™ Shelving

Uniquely Suited for Coolers  
Metroseal 3 with Removable Polymer Mats



- Corrosion Resistant — 12 year warranty against rust and corrosion. Removable polymer shelf mats are warranted against corrosion for life.
- Microban® antimicrobial product protection inhibits the growth of mold, mildew and bacteria.
- Durable — polymer shelf mats withstand the rigors of daily use.
- Cleanable — lift off shelf mats are sized to fit in a sink or commercial dish washer.

See pages 32-35



## MetroMax Q®

Perfect for meat, produce, deli and dairy coolers or freezers.

- Perfect for Cooler Storage.
- **Corrosion Resistant** — 15 year warranty against rust and corrosion.
- **Microban® Antimicrobial** product protection is built into shelves and all touch points inhibiting the growth of mold, mildew and bacteria.
- **Lift-off shelf mats** make cleaning a snap.
- Built-in levers for easy adjustment.
- Grid and solid shelf mats are available.

See pages 10-28



## MetroMax i®

The ultimate solution for damp, cold environments.

- The **BEST SOLUTION** for cooler or freezer storage.
- **Corrosion Proof** — Lifetime Warranty against rust and corrosion.
- **Microban® Antimicrobial** product protection is built into shelves and all touch points inhibiting the growth of mold, mildew and bacteria.
- **Lift-off shelf mats** make cleaning a snap.
- Grid and solid shelf mats are available.

See pages 10-28



A METRO EXCLUSIVE  
**Microban®**  
antimicrobial product protection



**NEW**  
**APPEAL™**  
**DISPLAY**  
**SHELVING**

The look that sells is also the look that moves. Appeal's curved front moves product right off the shelf and moves customers to make purchase decisions.

Stay ahead of the curve with the innovative, fully adjustable line of Metro retail shelving solutions. And take advantage of the look that sells, and sells, and sells.

PATENT PENDING



APPEAL Display Shelving

Perfect for end caps or create your own Store-Within-A-Store.

- **Curve APPEAL:** The shelf's attractive, curved front edge draws customers' attention to the products displayed. The open wire design promotes light penetration and visibility of displayed items.
- **Increase Facings:** The curved front design increases shelf storage area by 12% versus a traditional rectangular shelf.
- **Versatile:** Metro APPEAL™ shelving can be combined with Metro's Super Erecta, qwikSLOT™, or Drop Mat Display shelving systems to create a proprietary display for your store.
- **Fast, Secure Assembly:** SiteSelect™ posts, with Triple-groove visual guide feature, have circular grooves at 1" (25mm) intervals and are numbered at 2" (50 mm) intervals. A patented, tapered split sleeve snaps together around each post. Tapered openings in the shelf corners slide over the tapered split sleeves and provide a positive lock. Shelving is assembled in minutes without the use of any special tools.
- **Adjustability:** Shelves can be adjusted at 1" (25 mm) intervals along the length of the post.
- **Finishes:** Metro's APPEAL™ shelving is available in a chrome-plated finish or black epoxy coating.



Shelves

Width/Length (in.) (mm)	Approx. Pkd. Wt. (lbs.) (kg)	Cat. No. APPEAL Shelving Chrome	Cat. No. APPEAL Shelving Black
18x36 457x914	9 4.1	1836RC	1836RBL
18x48 457x1219	12 5.4	1848RC	1848RBL

SiteSelect™ Posts — 10.01a

Height* (in.) (mm)	Approx. Pkd. Wt. (lbs.) (kg)	STATIONARY		MOBILE	
		Cat. No. Chrome	Cat. No. Black	Cat. No. Chrome	Cat. No. Black
7½ 191	½ 0.3	7P	7PBL	—	—
14½ 370	1 0.5	13P	13PBL	—	—
27½ 699	1¾ 0.75	27P	27PBL	27UP	27UPBL
34½ 875	2 0.9	33P	33PBL	33UP	33UPBL
54 <sup>9</sup> / <sub>16</sub> 1385	3 1.4	54P	54PBL	54UP	54UPBL
62 <sup>9</sup> / <sub>16</sub> 1590	3½ 1.6	63P	63PBL	63UP	63UPBL
74 <sup>5</sup> / <sub>8</sub> 1895	4 1.8	74P	74PBL	74UP	74UPBL
86 <sup>5</sup> / <sub>8</sub> 2200	5 2.3	86P	86PBL	86UP	86UPBL
96 <sup>5</sup> / <sub>8</sub> 2454	5½ 2.5	***96P	—	—	—

\*Height includes leveling bolt and cap.

\*\*\*96P should not be used on units less than 24" (610mm) deep. Consult Metro Engineering for alternate recommendations.

†Note: Special length posts are available, priced at next higher length plus a cutting charge. Post lengths to be specified as cut to a round number, ie: 74P cut to 69" (1753mm) . . . This will result in an overall post height with adjustment of 69<sup>3</sup>/<sub>8</sub>" (1762mm) to 69<sup>5</sup>/<sub>8</sub>" (1775mm).

Mobile posts come without leveling bolt assembly to accommodate stem casters.

APPEAL™  
Display Shelving

SUPER ERECTA® SHELVING  
WITH AN ACCENTED CURVED  
FRONT. PERFECT FOR END  
CAP DISPLAYS OR TO CREATE  
A STORE-WITHIN-A-STORE  
DISPLAY!

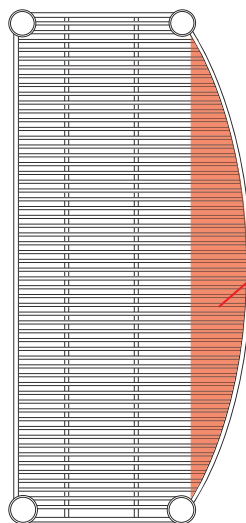

**12%  
MORE**  
Holding Power  
gets you  
More SKU's,  
More Facing,  
More Sales & Profits!

# Increase profits — Create your own “Store-Within-A-Store.”™

Research shows sales and profits increase more than **43%**.

Data was collected from ten stores operated by three food retailers in the United States. The research covered 15 product categories and thousands of items. The research was conducted by Willard Bishop Consulting Ltd. and involved two areas of research:

- In-store merchandising tests and point-of-sale data analysis to quantify sales/profits and total category impact.
- Consumer focus groups to qualify consumer reaction.

Visit [www.metro.com/grocerysolutions](http://www.metro.com/grocerysolutions) and click on the link to Store-Within-A-Store Research.

**Sales and profits for specialty items increased more than 43%. Total category performance demonstrated a 12+% increase in sales and 14+% increase in profits.**

## Uniquely profitable.

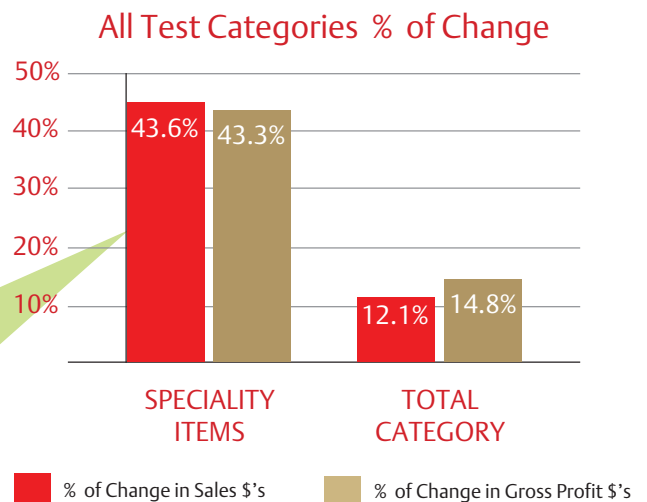

qwikSLOT™ Display Shelving makes creating your Store-Within-A-Store simple and easy.



## qwikSLOT™ Display Shelving System Set, Reset in a Flash.

Metro qwikSLOT shelves offer the quality of Super Erecta with the convenience of easily adjustable and removable shelves.

- Unique support system snaps into the posts, allowing instant shelf adjustment.
- Each unit requires a standard Super Erecta shelf at the top and bottom. (see page 42)

### qwikSLOT™ Shelves — 10.11

Width/Length (in.)	Approx. Pkd. Wt. (lbs.)	Cat. No. Super Erecta Brite	Cat. No. Chrome	Cat. No. Black	Cat. No. White	Cat. No. Smoked Glass
14x36	7.25	1436QBR	1436QC	1436QBL	1436QW	1436Q-DSG
14x48	9.75	1448QBR	1448QC	1448QBL	1448QW	1448Q-DSG
18x36	8.5	1836QBR	1836QC	1836QBL	1836QW	1836Q-DSG
18x48	11.25	1848QBR	1848QC	1848QBL	1848QW	1848Q-DSG
18x60	17.0	1860QBR	—	—	—	—
21x36	10.75	2136QBR	2136QC	2136QBL	2136QW	2136Q-DSG
21x48	13.25	2148QBR	2148QC	2148QBL	2148QW	2148Q-DSG
21x60	18.0	2160QBR	—	—	—	—
24x36	12.25	2436QBR	2436QC	2436QBL	2436QW	2436Q-DSG
24x48	15.25	2448QBR	2448QC	2448QBL	2448QW	2448Q-DSG
24x60	21.00	2460QBR	—	—	—	—

**Note:** A typical unit will incorporate 4 qwikSLOT posts, at least 2 standard Super Erecta shelves (one at the top and bottom of unit) and as many qwikSLOT shelves as desired between the top and bottom shelf.

**Note:** A qwikSLOT shelf is rated at 300 lbs. (135kg) per shelf. A typical qwikSLOT unit is rated at 800 lbs. (375kg) capacity per unit. For higher unit capacities, an intermediate standard Super Erecta shelf must be installed approximately at mid-height on the unit.

**Note:** Mobile Applications: All mobile applications require an intermediate standard Super Erecta shelf installed approximately at mid-height on the unit.



Super Erecta qwikSLOT™ shelving unit in black epoxy



qwikSLOT post with shelf clip

### qwikSLOT™ Posts — 10.11

Clips snap into slots along the height of the post for shelf adjustment at 1" (25mm) intervals. Use for qwikSLOT shelving only.

#### Stationary

Height† (in.)	Height† (mm)	Approx Pkd. Wt. (lbs.)	Approx Pkd. Wt. (kg)	Cat. No. Super Erecta Brite	Cat. No. Black	Cat. No. White	Cat. No. Smoked Glass
34 <sup>1</sup> / <sub>2</sub>	875	2	0.9	33PQ	33PQBL	33PQW	33PQ-DSG
54 <sup>9</sup> / <sub>16</sub>	1385	3	1.4	54PQ	54PQBL	54PQW	54PQ-DSG
63 <sup>9</sup> / <sub>16</sub>	1590	3 <sup>1</sup> / <sub>2</sub>	1.6	63PQ	63PQBL	63PQW	63PQ-DSG
74 <sup>5</sup> / <sub>8</sub>	1895	4	1.8	74PQ	74PQBL	74PQW	74PQ-DSG
86 <sup>5</sup> / <sub>8</sub>	2200	5	2.3	86PQ	86PQBL	86PQW	86PQ-DSG

†Height includes leveling bolt and cap.

#### Mobile

Height† (in.)	Height† (mm)	Approx Pkd. Wt. (lbs.)	Approx Pkd. Wt. (kg)	Cat. No. Super Erecta Brite	Cat. No. Black	Cat. No. White	Cat. No. Smoked Glass
33 <sup>7</sup> / <sub>8</sub>	861	2	0.9	33UPQ	33UPQBL	33UPQW	33UPQ-DSG
54	1370	3	1.4	54UPQ	54UPQBL	54UPQW	54UPQ-DSG
62	1575	3 <sup>1</sup> / <sub>2</sub>	1.6	63UPQ	63UPQBL	63UPQW	63UPQ-DSG
74	1880	4	1.8	74UPQ	74UPQBL	74UPQW	74UPQ-DSG
86	2185	5	2.3	86UPQ	86UPQBL	86UPQW	86UPQ-DSG

These posts come without leveling bolt assembly to accommodate stem casters.

For Mobile Applications refer to pages 48-49.

For a complete palette of Designer Colors, see page 127.

For Seismic Applications refer to pages 104-105.



#### qwikSLOT Locking Clip

Recommended for mobile applications. Must be used with 9985QS shelf clips. (Package of 4)  
Cat. No. **9985QSL**



#### Replacement qwikSLOT Shelf Clips

(Package of 4)  
Cat. No. **9985QS**

## HOW TO SET UP YOUR METRO STORE-WITHIN-A-STORE

### THREE EASY STEPS:

1. Assemble your new Metro Display Shelving System (no tools required).
2. Remove upper shelves of your existing gondola unit. Do not remove the base shelf or kick panel.
3. Place your new Metro display shelving unit onto the gondola base shelf and slide into place.

**Metro Tip:** Order optional triangular foot plates to replace leveling bolts. Foot plates distribute heavy weight more evenly. (See page 44).



# Uniquely efficient.

## Drop Mat™ Display Shelving.

Increase your shelving holding power by up to 30%.



DropMat yields space saving results. DropMat space gain is undeniable.

What would you do with 30% more display space?

- Add Sku's?
- Add Facings?
- Cross Merchandise?
- Expand Category or Departmental Floor Space?
- Widen Aisles?
- Create "Boutique" Areas?



What's the secret to increasing holding power?

- The secret to Metro's space-saving advantage is Drop Mat's "thin shelf" design ( $\frac{1}{4}$ " versus  $1\frac{1}{2}$ "). DropMat eliminates the need for space robbing under-shelf supports and bulky shelf brackets, reclaiming 20% of your merchandising space.
- Back-to-back, DropMat saves yet more space. Reclaim up to 10% additional space by eliminating traditional gondola's 4" wide center support structure.

**Metro Tip:** Visit [metro.com/grocerysolutions](http://metro.com/grocerysolutions) and click on the link for Drop Mat demonstration to see how Metro's Drop Mat Display System increases holding power.

**Metro Tip:** Visit [metro.com/grocerysolutions](http://metro.com/grocerysolutions) and click on the link for Drop Mat case studies to review plannogram data demonstrating Drop Mat's increased holding power.

## qwikSLOT™ Drop Mat™ and Drop Mat™ Super Erecta® Display Shelving — 10.12

- Built-in shelf ledge, approximately 1" (25mm) high, provides security, preventing contents from falling off shelf.
- Each shelf holds up to 250 pounds (113kg). Available in Super Erecta and qwikSLOT styles.

## qwikSLOT™ Drop Mat Shelves — 10.11

Drop Mat shelving can increase storage capacity by as much as 30%. Each shelf holds up to 250 pounds (113kg), qwikSLOT style promotes ease of adjustment and removal. Each qwikSLOT unit requires the use of a Super Erecta or Drop Mat Super Erecta shelf at top and bottom. Use with qwikSLOT posts.

Width/Length (in.)	Approx. Pkd. Wt. (lbs.)	Cat. No. Super Erecta Brite	Cat. No. Chrome	Cat. No. Black	Cat. No. White	Cat. No. Smoked Glass
14x36	7.25	HDM1436QBR	HDM1436QC	HDM1436QBL	HDM1436QW	HDM1436Q-DSG
14x48	9.75	HDM1448QBR	HDM1448QC	HDM1448QBL	HDM1448QW	HDM1448Q-DSG
18x36	8.5	HDM1836QBR	HDM1836QC	HDM1836QBL	HDM1836QW	HDM1836Q-DSG
18x48	11.25	HDM1848QBR	HDM1848QC	HDM1848QBL	HDM1848QW	HDM1848Q-DSG
21x36	10.75	HDM2136QBR	HDM2136QC	HDM2136QBL	HDM2136QW	HDM2136Q-DSG
21x48	13.25	HDM2148QBR	HDM2148QC	HDM2148QBL	HDM2148QW	HDM2148Q-DSG
24x36	12.25	HDM2436QBR	HDM2436QC	HDM2436QBL	HDM2436QW	HDM2436Q-DSG
24x48	15.25	HDM2448QBR	HDM2448QC	HDM2448QBL	HDM2448QW	HDM2448Q-DSG



Drop Mat Shelving Unit

## Drop Mat™ Super Erecta® Display Shelving — Use with qwikSLOT or Super Erecta posts

Width/Length (in./mm)		Approx. Pkd. Wt. (lbs./kg)		Cat. No. Super Erecta Brite	Cat. No. Chrome	Cat. No. Black	Cat. No. White	Cat. No. Smoked Glass
14x36	355x914	7.25	3.2	HDM1436BR	HDM1436NC	HDM1436BL	HDM1436W	HDM1436-DSG
14x48	355x1219	9.75	4.3	HDM1448BR	HDM1448NC	HDM1448BL	HDM1448W	HDM1448-DSG
18x36	457x914	8.5	3.8	HDM1836BR	HDM1836NC	HDM1836BL	HDM1836W	HDM1836-DSG
18x48	457x1219	11.25	5.0	HDM1848BR	HDM1848NC	HDM1848BL	HDM1848W	HDM1848-DSG
21x36	530x914	10.75	4.8	HDM2136BR	HDM2136NC	HDM2136BL	HDM2136W	HDM2136-DSG
21x48	530x1219	13.25	5.9	HDM2148BR	HDM2148NC	HDM2148BL	HDM2148W	HDM2148-DSG
24x24	610x614	8.5	3.8	HDM2424BR	HDM2424NC	HDM2424BL	HDM2424W	HDM2424-DSG
24x36	610x914	12.25	5.5	HDM2436BR	HDM2436NC	HDM2436BL	HDM2436W	HDM2436-DSG
24x48	610x1219	15.25	6.8	HDM2448BR	HDM2448NC	HDM2448BL	HDM2448W	HDM2448-DSG

## qwikSLOT™ Posts — 10.11

For a complete palette of Designer Colors, see page 127.

Clips snap into slots along the height of the post for shelf adjustment at 1" (25mm) intervals. Use for qwikSLOT shelving only.

Height† (in./mm)		Approx. Pkd. Wt. (lbs./kg)		STATIONARY				MOBILE			
		Cat. No. Plated	Cat. No. Black	Cat. No. White	Cat. No. Smoked Glass	Cat. No. Plated	Cat. No. Black	Cat. No. White	Cat. No. Smoked Glass		
34 1/2	875	33PQ	33PQBL	33PQW	33PQ-DSG	33UPQ	33UPQBL	33UPQW	33UPQ-DSG		
54 9/16	1385	54PQ	54PQBL	54PQW	54PQ-DSG	54UPQ	54UPQBL	54UPQW	54UPQ-DSG		
63 9/16	1590	63PQ	63PQBL	63PQW	63PQ-DSG	63UPQ	63UPQBL	63UPQW	63UPQ-DSG		
74 5/8	1895	74PQ	74PQBL	74PQW	74PQ-DSG	74UPQ	74UPQBL	74UPQW	74UPQ-DSG		
86 5/8	2200	86PQ	86PQBL	86PQW	86PQ-DSG	86UPQ	86UPQBL	86UPQW	86UPQ-DSG		

†Height includes leveling bolt and cap.

## Super Erecta SiteSelect™ Posts — 10.01a

Height* (in./mm)		Approx. Pkd. Wt. (lbs./kg)		STATIONARY		MOBILE	
		Cat. No. Chrome	Cat. No. Black	Cat. No. Chrome	Cat. No. Chrome	Cat. No. Plated	
7 1/2	191	7P	7PBL	—	—	—	
14 1/2	370	13P	13PBL	—	—	—	
27 1/2	699	27P	27PBL	27UP	—	27UPBL	
34 1/2	875	33P	33PBL	33UP	—	33UPBL	
54 9/16	1385	54P	54PBL	54UP	—	54UPBL	
62 9/16	1590	63P	63PBL	63UP	—	63UPBL	
74 5/8	1895	74P	74PBL	74UP	—	74UPBL	
86 5/8	2200	86P	86PBL	86UP	—	86UPBL	
96 5/8	2454	***96P	—	—	—	—	

Mobile posts come without leveling bolt assembly to accommodate stem casters. \*Height includes leveling bolt and cap. \*\*\*96P should not be used on units less than 24" (610mm) deep. Consult Metro Engineering for alternate recommendations. †Note: Special length posts are available, priced at next higher length plus a cutting charge. Post lengths to be specified as cut to a round number, ie: 74P cut to 69" (1753mm) ... This will result in an overall post height with adjustment of 69 9/16" (1762mm) to 69 7/8" (1775mm).

## Snap-On Dividers for Drop Mat Shelves — 10.04

Organize your shelves with these 8" (203mm) high, easy to snap-in-place dividers.

Fits Shelf Width (in./mm)	Approx. Pkd. Wt. (lbs./kg)	Cat. No. Plated	Cat. No. Black	Cat. No. White	Cat. No. Smoked Glass	Cat. No. Designer Colors*
18	457	HD18C	HD18B	HD18W	HD18-DSG	HD18-D
24	614	HD24C	HD24B	HD24W	HD24-DSG	HD24-D

\*Refer to page 22 for information about Designer Colors.



Snap-On Divider

## Super Erecta Shelving — 10.14

Available in a wide spectrum of colors that complement any decor.

Width/Length (in.) (mm)		Approx. Pkd. Wt. (lbs.) (kg)		Cat. No. Super Erecta Brite	Cat. No. Chrome	Cat. No. Black	Cat. No. White	Cat. No. Smoked Glass
14x24	355x610	6	2.7	1424BR	1424NC	1424NBL	1424NW	1424N-DSG
14x30	355x760	7	3.2	1430BR	1430NC	1430NBL	1430NW	1430N-DSG
14x36	355x914	8	3.6	1436BR	1436NC	1436NBL	1436NW	1436N-DSG
14x42	355x1066	9 1/2	4.3	1442BR	1442NC	1442NBL	1442NW	1442N-DSG
14x48	355x1219	10 1/2	4.7	1448BR	1448NC	1448NBL	1448NW	1448N-DSG
14x60	355x1524	14	6.3	1460BR	1460NC	1460NBL	1460NW	1460N-DSG
14x72	355x1829	17	7.7	1472BR	1472NC	1472NBL	1472NW	1472N-DSG
18x18	457x457	6	2.7	—	1818NC	1818NBL	1818NW	1818N-DSG
18x24	457x610	7	3.2	1824BR	1824NC	1824NBL	1824NW	1824N-DSG
18x30	457x760	8	3.6	1830BR	1830NC	1830NBL	1830NW	1830N-DSG
18x36	457x914	9 1/2	4.3	1836BR	1836NC	1836NBL	1836NW	1836N-DSG
18x42	457x1066	11	5.0	1842BR	1842NC	1842NBL	1842NW	1842N-DSG
18x48	457x1219	12	5.4	1848BR	1848NC	1848NBL	1848NW	1848N-DSG
18x54	457x1370	14 1/2	6.6	1854BR	1854NC	1854NBL	1854NW	1854N-DSG
18x60	457x1524	17	7.7	1860BR	1860NC	1860NBL	1860NW	1860N-DSG
18x72	457x1829	20	9.1	1872BR	1872NC	1872NBL	1872NW	1872N-DSG
21x24	530x610	8	3.6	2124BR	2124NC	2124NBL	2124NW	2124N-DSG
21x30	530x760	9	4.1	2130BR	2130NC	2130NBL	2130NW	2130N-DSG
21x36	530x914	11	5.0	2136BR	2136NC	2136NBL	2136NW	2136N-DSG
21x42	530x1066	12	5.4	2142BR	2142NC	2142NBL	2142NW	2142N-DSG
21x48	530x1219	14	6.4	2148BR	2148NC	2148NBL	2148NW	2148N-DSG
21x54	530x1370	16	7.3	2154BR	2154NC	2154NBL	2154NW	2154N-DSG
21x60	530x1524	18	8.2	2160BR	2160NC	2160NBL	2160NW	2160N-DSG
21x72	530x1829	24	10.9	2172BR	2172NC	2172NBL	2172NW	2172N-DSG
24x24	610x610	9	4.1	2424BR	2424NC	2424NBL	2424NW	2424N-DSG
24x30	610x760	11	5.0	2430BR	2430NC	2430NBL	2430NW	2430N-DSG
24x36	610x914	13	5.9	2436BR	2436NC	2436NBL	2436NW	2436N-DSG
24x42	610x1066	15	6.8	2442BR	2442NC	2442NBL	2442NW	2442N-DSG
24x48	610x1219	16	7.3	2448BR	2448NC	2448NBL	2448NW	2448N-DSG
24x54	610x1370	19	8.6	2454BR	2454NC	2454NBL	2454NW	2454N-DSG
24x60	610x1524	21	9.5	2460BR	2460NC	2460NBL	2460NW	2460N-DSG
24x72	610x1829	26	11.8	2472BR	2472NC	2472NBL	2472NW	2472N-DSG

Note: White epoxy Super Erecta shelves come with white split sleeves.  
 Note: All Black, Smoked Glass and Designer Super Erecta shelves come with black split sleeves.  
 Note: Black shelving is NSF listed. White and Smoked Glass are not NSF listed.

## Super Erecta SiteSelect™ Posts — 10.14

STATIONARY								MOBILE (FOR STEM CASTERS)					
Height* (in.) (mm)		Approx. Pkd. Wt. (lbs.) (kg)		Cat. No. Chrome	Cat. No. Black	Cat. No. White	Cat. No. Smoked Glass	Approx. Pkd. Wt. (lbs.) (kg)	Cat. No. Chrome	Cat. No. Black	Cat. No. White	Cat. No. Smoked Glass	
7 1/2	191	1/2	0.3	7P	7PBL	7PW	7P-DSG	—	—	—	—	—	
14 1/2	370	1	0.5	13P	13PBL	13PW	13P-DSG	—	—	—	—	—	
27 1/2	699	1 3/4	0.75	27P	27PBL	27PW	27P-DSG	1 3/4	0.75	27UP	27UPBL	27UPW	27UP-DSG
34 1/2	875	2	0.9	33P	33PBL	33PW	33P-DSG	2	0.9	33UP	33UPBL	33UPW	33UP-DSG
54 9/16	1385	3	1.4	54P	54PBL	54PW	54P-DSG	3	1.4	54UP	54UPBL	54UPW	54UP-DSG
62 9/16	1590	3 1/2	1.6	63P	63PBL	63PW	63P-DSG	3 1/2	1.6	63UP	63UPBL	63UPW	63UP-DSG
74 5/8	1895	4	1.8	74P	74PBL	74PW	74P-DSG	4	1.8	74UP	74UPBL	74UPW	74UP-DSG
86 5/8	2200	5	2.3	86P	86PBL	86PW	86P-DSG	4.5	2.0	86UP	86UPBL	86UPW	86UP-DSG
96 5/8	2454	5 1/2	2.5	***96P	—	—	—	—	—	—	—	—	—

\*Height includes leveling bolt and cap.  
 \*\*\*96P should not be used on units less than 24" (610mm) deep. Consult Metro Engineering for alternate recommendations.  
 †Note: Special length posts are available, priced at next higher length plus a cutting charge.  
 Post lengths to be specified as cut to a round number, ie: 74P cut to 69" (1753mm) . . .  
 This will result in an overall post height with adjustment of 69 3/8" (1762mm) to 69 5/8" (1775mm).

These posts come without leveling bolt assembly to accommodate stem casters.  
 Casters for mobile applications can be found on pages 48 & 49.

### Standard Colors



## Designer Color Shelving (Super Erecta, Super Erecta Drop Mat, qwikSLOT, qwikSLOT Drop Mat) — 10.14

Available in a wide spectrum of colors that complement any décor or retail theme.

Width/Length (in.) (mm)		Approx. Pkd. Wt. (lbs.) (kg)		Cat. No. Super Erecta*	Cat. No. quwikSLOT*	Cat. No. Super Erecta Drop Mat*	Cat. No. quwikSLOT Drop Mat*
14x24	355x610	6	2.7	1424N-D			
14x30	355x760	7	3.2	1430N-D			
14x36	355x914	8	3.6	1436N-D	1436Q-D	HDM1436-D	HDM1436Q-D
14x42	355x1066	9 <sup>1</sup> / <sub>2</sub>	4.3	1442N-D			
14x48	355x1219	10 <sup>1</sup> / <sub>2</sub>	4.7	1448N-D	1448Q-D	HDM1448-D	HDM1448Q-D
14x60	355x1524	14	6.3	1460N-D			
14x72	355x1825	17	7.7	1472N-D			
18x18	457x457	6	2.7	1818N-D			
18x24	457x610	7	3.2	1824N-D			
18x30	457x760	8	3.6	1830N-D			
18x36	457x914	9 <sup>1</sup> / <sub>2</sub>	4.3	1836N-D	1836Q-D	HDM1836-D	HDM1836Q-D
18x42	457x1066	11	5.0	1842N-D			
18x48	457x1219	12	5.4	1848N-D	1848Q-D	HDM1848-D	HDM1848Q-D
18x54	457x1370	14 <sup>1</sup> / <sub>2</sub>	6.6	1854N-D			
18x60	457x1524	17	7.7	1860N-D			
18x72	457x1825	20	9.1	1872N-D			
21x24	530x610	8	3.6	2124N-D			
21x30	530x760	9	4.1	2130N-D			
21x36	530x914	11	5.0	2136N-D	2136Q-D	HDM2136-D	HDM2136Q-D
21x42	530x1066	12	5.4	2142N-D			
21x48	530x1219	14	6.4	2148N-D	2148Q-D	HDM2148-D	HDM2148Q-D
21x54	530x1370	16	7.3	2154N-D			
21x60	530x1524	18	8.2	2160N-D			
21x72	530x1825	24	10.9	2172N-D			
24x24	610x610	9	4.1	2424N-D			
24x30	610x760	11	5.0	2430N-D			
24x36	610x914	13	5.9	2436N-D	2436Q-D	HDM2436-D	HDM2436Q-D
24x42	610x1066	15	6.8	2442N-D			
24x48	610x1219	16	7.3	2448N-D	2448Q-D	HDM2448-D	HDM2448Q-D
24x54	610x1370	18	8.6	2454N-D			
24x60	610x1524	21	9.5	2460N-D			
24x72	610x1825	26	11.8	2472N-D			

**Note:** All designer Super Erecta shelves come with black split sleeves. Designer Super Adjustable Super Erecta shelves come with black wedges and connectors.

**Note:** Shelving is not cart washable, but can be wiped down with a mild detergent.

**Note:** The actual length of the shelves is 1/8" (3.2mm) shorter than the nominal dimension shown.

Packaging: Shelves and posts are carton packed, but sold separately.

### Designer Shelf Colors

\*To order a Designer Color, add the appropriate color suffix to the desired catalog numbers above (example: 18"x36" [457x914mm] Hunter Green Shelf = 1836N-DHG).

- BM — Black Matte      SH — Silver Hammertone      HG — Hunter Green
- F — Flame            CH — Copper Hammertone



Black Matte (BM)

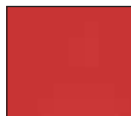

Flame (F)



Hunter Green (HG)



Copper Hammertone (CH)

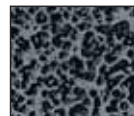

Silver Hammertone (SH)

For standard finishes: Chrome, Black, White, Smoked Glass, please refer to pages 37, 42, 123 and 126. For accessories in Designer Colors, see pages 53 and 58.

### Posts

Round posts have a 1" (25mm) diameter. Shelves can be adjusted at 1" (25mm) increments for maximum adaptability to your changing retail needs.

Height† (in.) (mm)	Approx. Pkd. Wt. (lbs.) (kg)	Super Erecta Shelving		quwikSLOT			
		Super Adjustable Super Erecta		Cat. No. Stationary*	Cat. No. Mobile*	Cat. No. Stationary*	Cat. No. Mobile*
7 <sup>1</sup> / <sub>2</sub>	191	1/2	0.3	7P-D			
14 <sup>1</sup> / <sub>2</sub>	370	1	0.5	13P-D			
34 <sup>1</sup> / <sub>2</sub>	875	2	0.9	33P-D	33UP-D	33PQ-D	33UPQ-D
54 <sup>9</sup> / <sub>16</sub>	1385	3	1.4	54P-D	54UP-D	54PQ-D	54UPQ-D
62 <sup>9</sup> / <sub>16</sub>	1590	3 <sup>1</sup> / <sub>2</sub>	1.6	63P-D	63UP-D	63PQ-D	63UPQ-D
74 <sup>5</sup> / <sub>8</sub>	1895	4	1.8	74P-D	74UP-D	74PQ-D	74UPQ-D
86 <sup>5</sup> / <sub>8</sub>	2200	5	2.3	86P-D	86UP-D	86PQ-D	86UPQ-D

†Height includes leveling bolt and cap.



5MB  
(shown with brake)



HDC5B



1" (25mm) Ledge

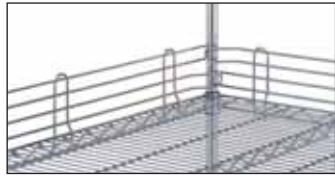

4" (100mm) Ledge



Shelf Divider for Super Erecta Shelves



Large Display/Storage Basket



Decorator Shelf Inlays



Clear Shelf Inlays

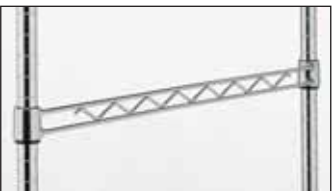

Hanger Rail



Snap-On Hooks

**Casters — 11.20**

Use with Super Erecta or quikSLOT posts and shelves to create a mobile shelving unit to meet your special needs. See pages 37 and 42.

**Shelf Ledges — Side and Back — 10.05**

For stationary or mobile installations, ledges prevent items from protruding or falling from shelves. See page 53.

**Shelf Dividers — 10.05**

Keep shelf contents orderly with these 8" (203mm) high, pressure-fit dividers. See page 53.

**Storage Baskets — 10.05**

Generous-sized baskets attach in seconds to hanger rail or shelves. See page 58.

**Decorator Shelf Inlays — 10.06**

Hardboard mats prevent small items from falling through wire shelves. Fit between posts and level with top of shelf edge. Reversible, black and white. See page 56.

**Clear Shelf Inlays — 10.06**

Nearly invisible plastic mat retains open-wire look of shelves and allows light penetration. See page 56.

**Hanger Rails — 10.05**

Convenient rail fits on posts along the width or length of the unit. Optional hooks can hang from rail at any point. See page 55.

**Snap-On Hooks — 10.05**

Multi-purpose hooks in three styles attach to hanger rails, mounting rails or shelves for instant access. See page 56.



**Extension Display Hanger — 10.05**

Snaps on Super Erecta Shelf hanger rails and shelf frames. Accepts standard carded merchandise. See page 58.



Extension Display Hanger



Swing Hanger

**Swing Hanger — 10.05**

Attaches to post to provide convenient storage for hanging items or signage. Red epoxy finish. See page 58.

**Clear Label Holders — 10.05**

Clear plastic allows decorator colors to show through. Holds most commercial 1 1/4" (32mm) labels. See page 59.



Clear Label Holder



Slanted Label Holder

**Slanted Label Holders — 10.05**

Gray solid plastic holder puts 1 1/4" (32mm) labels on slant for easier viewing. See page 59.

**Color Shelf Marker — 10.05**

Color code for effective organization. Snaps securely to the front edge of Super Erecta and Super Adjustable Super Erecta Wire Shelving. See page 59.

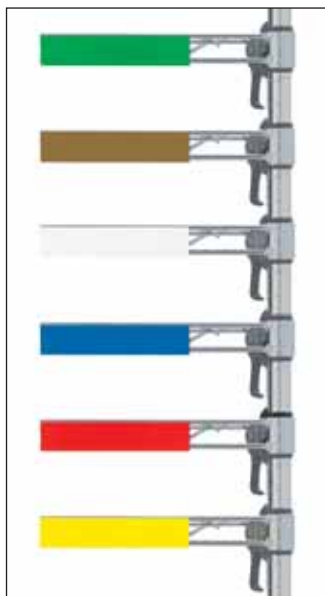

Color Shelf Markers



Rod with Tab in place

**Rods and Tabs — 10.04**

Form side and back enclosures for a shelving unit. Can also serve as uniform dividers within unit by passing through shelves from top to bottom. See page 55.



Hanger Tube with Brackets

**Hanger Tube with Brackets — 10.05**

Hanger tubes attach easily under Super Erecta shelves for hanging garments. See page 56.

**Post Clamps — 10.06**

Joins units together for maximum strength. See page 44.



Post Clamp



Foot Plate

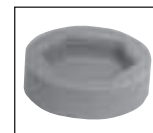

Glide

**Foot Plates — 10.06**

Use to bolt units to the floor, or when a broader, more stable foot is desired. See page 44.

**Glides — 10.06**

Smooth polymer cover fits over leveling bolt to protect floors. See page 44.



Decorative Leveling Foot

**Decorative Leveling Foot — 10.06**

Decorative alternative for post. Compensates for uneven surfaces. See page 44.



Tiered Shelving with Post Connectors

**Post Connectors — 10.15**

Attach posts of upper shelves to lower level frame or mat to create tiered shelving.

Type of Connectors	Finish	Approx. Pkd. Wt. (lbs.) (kg)		Cat. No.
4 Post-to-Shelf Frame	Black	1	.5	<b>HFCB</b>
4 Post-to-Shelf Mat	Black	2	1	<b>HMCB</b>
4 Post-to-Shelf Mat	Chrome	2	1	<b>HMCC</b>



Basket Shelf  
(Posts sold separately, see page 42)

**Basket Shelf — 10.04**

3 1/2" (89mm) deep basket with 400 lb. (182kg) weight capacity. Ideal for cross merchandising in front of display cases or driving impulse sales. For basket shelf cart, see page 46.

Size (in.)	Size (mm)	Cat. No. Chrome	Cat. No. Black
14x36	355x914	—	<b>DD3448A</b>
14x48	355x1219	—	<b>DD3448B</b>
18x36	457x914	<b>CC9744A</b>	<b>CC9744C</b>
18x48	457x1219	<b>CC9744</b>	<b>CC9744B</b>



Triangle Shelving Unit with four triangle shelves and three Super Erec posts.

**Triangle Shelves — 10.04**

Put unused corner space to work while keeping traffic aisles clear.

- Shelf sizes corresponding to width (depth) of shelving for add-on capabilities.
- Shelves attach to standard Super Erecta or qwikSLOT posts, see pages 42 and 123.

Size Width (in.)	Size (mm)	Approx. Pkd. Wt. (lbs.) (kg)		Cat. No. Chrome	Cat. No. Black
18	457	15 1/2	7	<b>H18TRC</b>	<b>H18TRB</b>
24	610	21 1/2	10	<b>H24TRC</b>	<b>H24TRB</b>

Weight load capacity: 200 lbs. (91kg) per shelf; 400 lbs. (182kg) per unit.



Cantilever Shelves

**Cantilever Shelves — 10.06**

Adds convenient space above a storage unit. Drop mat design creates a retaining ledge around the entire 12" (305mm) deep shelf. See page 45.

Display Platforms — 10.44

Super Erecta Display Platforms are ideal for displaying large, bulky items, boxed goods or cross merchandising. All platforms come with 13" (330mm) posts.

Width/Length (in.) (mm)		Approx. Pkd. Wt. (lbs.) (kg)		Cat. No. Chrome
18x24	457x610	11	5.0	P1824NC
18x30	457x760	12	5.5	P1830NC
18x36	457x914	13½	6.1	P1836NC
21x24	530x610	12	5.5	P2124NC
21x30	530x760	13	5.9	P2130NC
21x36	530x914	15	6.8	P2136NC
24x24	610x610	13	5.9	P2424NC
24x30	610x760	15	6.8	P2430NC
24x36	610x914	17	7.7	P2436NC



Display Platforms

Slanted-Shelf Merchandisers — 50.50

A premium presentation, slanted shelves add visibility and accessibility. Loading is quick, easy, and organized.

- Open wire construction and slope of shelves promote visibility.
- Shelves are adjustable at 1" (25mm) intervals along the height of the post.
- 5" (127mm) casters add mobility, while brakes lock firmly in position.

Width (in.) (mm)		Length (in.) (mm)		Height (in.) (mm)		Approx. Pkd. Wt. (lbs.) (kg)		Shelves	Cat. No.
18	457	24	610	60	1524	103	46.3	Four Slanted Shelves One Flat Top Shelf (Pkg. of 12 dividers)	DC15EC
18	457	24	610	60	1524	112	50.4	Five Slanted Shelves (Pkg. of 12 dividers)	DC16EC
18	457	36	914	60	1524	95	42.7	Four Slanted Shelves One Flat Top Shelf	DC35EC
18	457	36	914	70	1778	104	46.8	Five Slanted Shelves	DC36EC
18	457	48	1219	60	1524	112	50.4	Four Slanted Shelves One Flat Top Shelf	DC55EC
18	457	48	1219	70	1778	123	55.3	Five Slanted Shelves	DC56EC

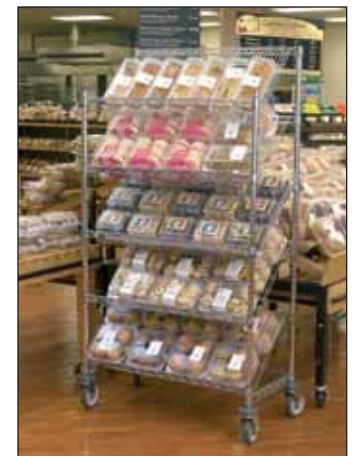

Slanted Shelf Merchandiser/  
Dispenser Rack  
DC56EC

Additional Shelves

Additional shelves are 18" (457mm) wide.

Length (in.) (mm)		Approx. Pkd. Wt. (lbs.) (kg)		Cat. No.
24	610	10.5	4.7	1824DNC
36	914	14	6.3	1836DNC
48	1219	18	8.1	1848DNC

Additional Dividers

Keeps different types of merchandise separated and in order.

Size Width/Length (in.) (mm)		Approx. Pkd. Wt. (lbs.) (kg)		Cat. No.
4x17	100x430	8	3.6	DCR17C





Wine Cart

## Super Erecta® Wine Storage and Display

Store it! . . . Display it! . . . Sell it! . . .

As more wine makers introduce new labels it is important as a merchandiser to store and sell product in an organized manner. Metro offers unique wine storage and display solutions designed for merchandising.

### Wine Cart

Mobile wine merchandiser is perfect for creating “impulse” opportunities. The Wine Cart consists of the following components:

- 2 – 1436NC shelves – see page 42
- 1 – 1236CSNC cantilever shelf – see page 45
- 2 – 13UP posts (cut to 7" [178mm]) – see page 42
- 2 – 27UP posts – see page 42
- 2 – 5M swivel casters – see page 48
- 2 – 5MB swivel/brake casters – see page 48



### Super Erecta Display Shelving

The open design of Super Erecta Display Shelving creates a “wall of product.” For chrome-plated or standard epoxy colors (black, white, smoked glass), see pages 42-43 and 122-129.

For Designer Color Shelving, see pages 43 and 127.

### Cradle Wine Units

- Wire creates highly visible display.
- Wire forms a cradle that nests individual bottles.
- Shelves spread 5" (127mm) apart for easy access.
- Open wire permits free air circulation around bottles.

Width/Length (in.) (mm)		Overall Height (in.) (mm)		Capacity (750ml bottles)	Approx. Pkd. Wt. (lbs.) (kg)		Cat. No. Chrome
14x36	355x914	74 <sup>3</sup> / <sub>4</sub>	1899	126	112	51	<b>WC237C</b>
14x36	355x914	86 <sup>3</sup> / <sub>4</sub>	2203	153	133	60	<b>WC238C</b>
14x48	355x1219	74 <sup>3</sup> / <sub>4</sub>	1899	168	133	60	<b>WC257C</b>
14x48	355x1219	86 <sup>3</sup> / <sub>4</sub>	2203	204	160	73	<b>WC258C</b>

All models include foot plates for stability and easy leveling.



WC257C Cradle Shelving

### Cradle Wine Shelves

Width/Length (in.) (mm)		Capacity (750ml bottles)	Approx. Pkd. Wt. (lbs.) (kg)		Cat. No.
14x36	355x914	9	7	3.2	<b>W1436NC</b>
14x48	355x1219	12	8.5	3.8	<b>W1448NC</b>

### Bulk Wine Units

- Store large quantities in limited space – average one case per linear foot of shelf.
- Keep corks moist – inserts hold bottle at 10° slant.
- Open wire design allows air flow for proper temperature maintenance.
- Units enclosed to secure product.
- Optional locking doors available for the 16-case unit.
- Large 15" (381mm) space between shelves.

Width/Length (in.) (mm)		Overall Height (in.) (mm)		Capacity (Cases of 750ml bottles)	Approx. Pkd. Wt. (lbs.) (kg)		Cat. No. Chrome
14x36	355x914	74 <sup>3</sup> / <sub>4</sub>	1899	12	138	63	<b>WB237C</b>
14x36	355x914	86 <sup>3</sup> / <sub>4</sub>	2203	15	168	76	<b>WB238C</b>
14x48	355x1219	74 <sup>3</sup> / <sub>4</sub>	1899	16	168	76	<b>WB257C</b>
14x48	355x1219	86 <sup>3</sup> / <sub>4</sub>	2203	20	204	93	<b>WB258C</b>

All models include foot plates for stability and easy leveling.

### 14" (355mm) Flat Wire Shelves

May be used

Width/Length (in.) (mm)		Approx. Pkd. Wt. (lbs.) (kg)		Cat. No.
14x36	355x914	9.5	4.3	<b>1436NC</b>
14x48	355x1219	12	5.4	<b>1448NC</b>



WB257C Bulk Shelving

End Load and Side Load Wire Bun Pan Racks — **13.42** **NSE**

Economical solution for on-site storage and transport of trays.

- End-load models provide a large tray landing area, side-load models are highly space efficient
- Choice of 1 1/2" (38mm) spacing (38 pans) or 3" (76mm) (20 pans) spacing.
- Quick, easy no-tool assembly, rolls easily on 5" (127mm) swivel casters.
- Durable, Super Erecta Brite™ finish.

Width/Length (in.) (mm)	Height (in.) (mm)	Slide Spacing (in.) (mm)	Pan Capacity			Approx. Pkd. Wt.		Description	Cat. No.			
			No.	(in.)	Size (mm)	(lbs.)	(kg)					
21 3/4x27	552x685	69	1752	1 1/2	38	38	18x26	457x660	61	27.7	End-Load	<b>RE1</b>
21 3/4x27	552x685	69	1752	3	76	19	18x26	457x660	70	31.8	End-Load	<b>RE3</b>
19 1/2x30	495x762	69	1752	1 1/2	38	38	18x26	457x660	61	27.6	Side-Load	<b>RS1</b>
19 1/2x30	495x762	69	1752	3	76	19	18x26	457x660	70	31.8	Side-Load	<b>RS3</b>

Weight Load Capacity: 30 lbs. (13.7kg) per level; 200 lbs. (90.7kg) per unit.



Wire Bun Pan Racks

Accessories

Description	Model
3 1/2" (90mm) Diameter Rubber Donut Bumper	<b>9992DB</b>
5 1/2" (140mm) Diameter Rubber Donut Bumper	<b>9992N</b>

Portable Wire Prep Rack — **13.44** **NSE**

Made to accommodate standard 18"x26" (457x660mm) trays or pans. The 1/2" (12.7mm) food grade polyethylene cutting board/work surface provides an area for slicing, mixing, garnishing or other types of food preparation. UPS shippable in one box, units assemble quickly and easily without special tools. Rolls easily on 5" (127mm) swivel casters.



Portable Wire Prep Rack (tray not included)

Width/Length (in.) (mm)	Height (in.) (mm)	Slide Spacing (in.) (mm)	Pan Capacity			Approx. Pkd. Wt.		Description	Cat. No.			
			No.	(in.)	Size (mm)	(lbs.)	(kg)					
21 3/4x27	550x685	38	1750	1 1/2	38	16	18x26	457x660	50	22.6	End-Load	<b>RE1P</b>
21 3/4x27	550x685	38	1750	3	76	8	18x26	457x660	60	27.2	End-Load	<b>RE3P</b>

Accessories

Description	Model
3 1/2" (90mm) Diameter Rubber Donut Bumper	<b>9992DB</b>
5 1/2" (140mm) Diameter Rubber Donut Bumper	<b>9992N</b>

Side Load "Knock Down" Racks — **13.72** **NSE**

Inside height 56 1/2" (1435mm).

Width/Length (in.) (mm)	Height (in.) (mm)	Slide Spacing (in.) (mm)	Pan Capacity			Approx. Pkd. Wt.		Cat. No.	
			No.	(in.)	Size (mm)	(lbs.)	(kg)		
28 3/8x64 1/8x18 3/4	721x1628x476	3	76	18	18x26	457x660	40	18	<b>RT3318N</b>
28 3/8x64 1/8x18 3/4	721x1628x476	5	127	11	18x26	457x660	38	17.1	<b>RT3511N</b>

Note: 5" (127mm) swivel casters, two with brakes, are standard on units listed above.



Side Load Rack (trays not included)

End Load "Knock Down" Racks — Single Section — **13.70** **NSE**

Inside height 55 7/8" (1417mm).

Width/Length (in.) (mm)	Height (in.) (mm)	Slide Spacing (in.) (mm)	Pan Capacity			Approx. Pkd. Wt.		Cat. No.	
			No.	(in.)	Size (mm)	(lbs.)	(kg)		
20 3/8x64 1/8x28	518x1630x711	3	76	18	18x26	457x660	53	23.8	<b>RT183N</b>
				or 36	14x18	355x457			
20 3/8x64 1/8x28	518x1630x711	5	127	11	18x26	457x660	50	22.5	<b>RT115N</b>
				or 22	14x18	355x457			
20 3/8x64 1/8x28	518x1630x711	1 1/2	28	34	18x26	457x660	55	24.7	<b>RT1334N</b>

Note: 5" (127mm) swivel casters, two with brakes, are standard on units listed above.



End Load Rack

# NSF C5™ Heated Holding and Proofing Cabinets — See How Good a Heated Cabinet Can Be.™

The C5 line is a series of Heated Holding and Proofing Cabinets designed by working directly with chefs and operators to provide the features and benefits that are sure to satisfy the needs of any operation, anywhere in the world.

Metro cabinets are only to be used as Hot Food Holding Cabinets. They are meant to keep cooked food hot until served and are listed under UL 197 “Commercial Electric Cooking Appliances.” Do not use for non-food applications.



9 Series	8 Series	6 Series	3 Series*	1 Series
Digital Control of Temperature & Humidity (Holding & Proofing)	Digital Control of Temperature (Holding)	Basic Analog Control of Temperature (Holding)	Insulation Armour™ Provides Energy Efficient at an Affordable Price (Holding & Proofing)	Ideal for Proofing (Holding & Proofing)
				

**NOTE:** Full Height Cabinets shown. 3/4 Height, 1/2 Height and Under Counter models are available, as well as various door and pan slide configurations. For C5 specification, consult your Metro representative or visit us at [www.metro.com](http://www.metro.com).

\*Available in Blue, Red and Gray Insulation Armour.

### Stainless Steel Prep Tables

- Type 304 stainless steel—industry standard for food safety.
- Easy-to-clean, easy-to-move, easy-to-assemble.
- Strong structure can hold heavy equipment.
- Available in many sizes and styles, mobile and stationary.

For the full line of stainless top worktables, see pages 192 to 194.

Making the cut . . . Metro provides the highest quality prep tables.



### Smart Wall G3™ Wall Storage and Productivity System

- Corrosion resistant Metroseal 3 warranted against rust and corrosion for 12 years.
- Microban Antimicrobial Product Protection is built in — A Metro Exclusive.
- Keeps items within reach and above work surface or sinks.
- Many accessories available to promote efficiency.

To see the full line, turn to pages 72-77.



# Uniquely designed shelving to fit all your storage requirements.

## Food safety at the store level. Easy-to-clean, **MetroMax Q™ Shelving**



- **Corrosion Resistant**, 15 Year Warranty Against Rust and Corrosion
- **Cleanable**, easily Removable Shelf Mats are sized to fit into a sink or dishwasher
- **Microban® antimicrobial product protection** built-in
- **Quick-to-adjust** Shelves Provide Maximum Space Utilization
- Open Grid or Solid Shelf Mats Available

A METRO EXCLUSIVE  
**Microban®**  
antimicrobial product protection

All shelf mats, posts, and touch points have built in Microban® antimicrobial product protection. Keeping shelves cleaner between cleanings.

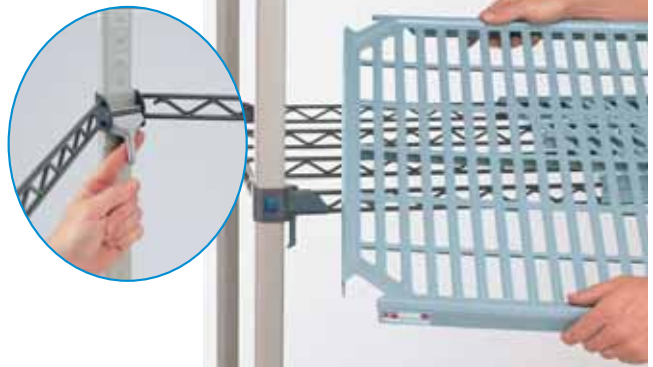

**NEW**

## Super Erecta Pro™ Shelving

**Metroseal 3**

- **Corrosion Resistant** — patented Metroseal 3 epoxy is warranted against rust and corrosion for 12 years. Removable polymer shelf mats are warranted against corrosion for life.
- **Microban® antimicrobial product protection** inhibits the growth of mold, mildew and bacteria.
- **Durable** — polymer shelf mats withstand the rigors of daily use.
- **Cleanable** — lift off shelf mats are sized to fit in a sink or commercial dish washer making cleaning a snap.

See pages 32-35



Inventory Storage — Wire — **10.01** **10.01a**

Super Adjustable Super Erecta is the most advanced and innovative wire storage system available. Patented design allows you to adjust your shelves without tools! Super Adjustable shelving will work with Super Erecta System of shelves and accessories!

Width/Length (in.) (mm)		Approx. Pkd Wt. (lbs.) (kg)		Cat. No. Chrome
14x24	355x610	6	2.7	A1424NC
14x30	355x760	7	3.2	A1430NC
14x36	355x914	8	3.6	A1436NC
14x42	355x1066	9½	4.3	A1442NC
14x48	355x1219	10½	4.7	A1448NC
14x60	355x1524	14	6.3	A1460NC
14x72	355x1825	17	7.7	A1472NC
18x24	457x610	7	3.2	A1824NC
18x30	457x760	8	3.6	A1830NC
18x36	457x914	9½	4.3	A1836NC
18x42	457x1066	11	5.0	A1842NC
18x48	457x1219	12	5.4	A1848NC
18x54	457x1370	14½	6.6	A1854NC
18x60	457x1524	17	7.7	A1860NC
18x72	457x1829	20	9.1	A1872NC
21x24	530x610	8	3.6	A2124NC
21x30	530x760	9	4.1	A2130NC
21x36	530x914	11	5.0	A2136NC
21x42	530x1066	12	5.4	A2142NC
21x48	530x1219	14	6.4	A2148NC
21x54	530x1370	16	7.3	A2154NC
21x60	530x1524	18	8.2	A2160NC
21x72	530x1829	24	10.9	A2172NC
24x24	610x610	9	4.1	A2424NC
24x30	610x760	11	5.0	A2430NC
24x36	610x914	13	5.9	A2436NC
24x42	610x1066	15	6.8	A2442NC
24x48	610x1219	16	7.3	A2448NC
24x54	610x1370	18	8.6	A2454NC
24x60	610x1524	21	9.5	A2460NC
24x72	610x1829	26	11.8	A2472NC
30x36	760x914	15	6.8	A3036NC
30x48	760x1219	21	9.5	A3048NC
30x60	760x1524	26½	11.8	A3060NC
30x72	760x1829	31	14.0	A3072NC
36x36	910x914	18	8.2	A3636NC
36x48	910x1219	23	10.4	A3648NC
36x60	910x1524	29	13.1	A3660NC
36x72	910x1829	34½	15.4	A3672NC

**Note:** For availability of Super Adjustable Shelving not listed above, contact your Metro representative.



Corner Release System

Shelves and posts are carton packed but sold separately.

Super Erecta SiteSelect™ Posts — **10.01a**

STATIONARY				MOBILE			
Height*		Approx. Pkd Wt.		Cat. No.	Approx. Pkd Wt.		Cat. No.
(in.)	(mm)	(lbs.)	(kg)	Chrome	(lbs.)	(kg)	Chrome
7½	191	½	0.3	7P			
14½	370	1	0.5	13P			
27½	699	1¾	0.75	27P	1¾	0.75	27UP
34½	875	2	0.9	33P	2	0.9	33UP
54 <sup>9</sup> / <sub>16</sub>	1385	3	1.4	54P	3	1.4	54UP
62 <sup>9</sup> / <sub>16</sub>	1590	3½	1.6	63P	3½	1.6	63UP
74 <sup>5</sup> / <sub>8</sub>	1895	4	1.8	74P	4	1.8	74UP
86 <sup>5</sup> / <sub>8</sub>	2200	5	2.3	86P	4.5	2.0	86UP
96 <sup>5</sup> / <sub>8</sub>	2454	5½	2.5	***96P			

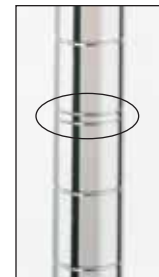

SiteSelect™ Posts are grooved at 1" (25mm) increments and numbered at 2" (50mm) increments. Posts are double-grooved every 8" (203mm) for easy identification.

\*Height includes leveling bolt and cap.  
**Note:** Special length posts are available, priced at next higher length plus a cutting charge.  
 Post lengths to be specified as cut to a round number, ie: 74P cut to 69" (1753mm) . . . This will result in an overall post height with adjustment of 69<sup>5</sup>/<sub>8</sub>" (1762mm) to 69<sup>7</sup>/<sub>8</sub>" (1775mm).  
 \*\*\*96P should not be used on units less than 24" (610mm) deep. Consult Metro Engineering for alternate recommendations.  
 Mobile posts come without leveling bolt assembly to accommodate stem casters.

### Wall Shelving

Choose wall shelving that meets your exact needs.



SmartWall G3™  
(See pages 72-77)



Super Erecta Shelving  
Post Mount  
(See page 79)



Erecta Shelf  
(See page 78)



### Stocking/Pricing Carts

Ideal for a large variety of tasks — stocking small items, janitorial supply areas, manager's offices. Select from wire and polymer options.



MetroMax i Stocking Carts  
(See page 81).



3-Shelf Deep Ledge Cart  
(See page 83)



2-Shelf BC Cart  
(See page 82)



### Dunnage

Perfect for storing large, bulky items. Choose chrome for dry environments. Choose Metroseal 3 or Bow-Tie Polymer Dunnage Racks for corrosive environments.



Super Erecta Dunnage  
(See page 98)

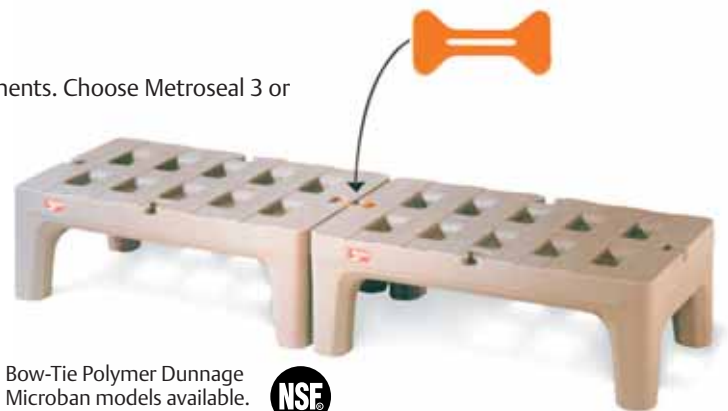

Bow-Tie Polymer Dunnage  
Microban models available.  
(See page 97)



\*MICROBAN® and the MICROBAN® symbol are registered trademarks of the Microban Products Company, Huntersville, NC.

## Super Adjustable Super Erecta Shelving Metroseal 3 Finish

- Corrosion Resistant — 12 year warranty against rust and corrosion.
- Unique Shelf Design: Super Adjustable™ offers the patented shelf release lever for fast and easy shelf adjustment at 1" (25mm) increments.
- Microban® antimicrobial product protection built-in.
- For ordering information, see pages 36-37.

A METRO EXCLUSIVE  
 antimicrobial product protection



## Super Erecta Pro™ Shelving Traditional style, uniquely suited for coolers.

**NEW**



- Corrosion Resistant — patented Metroseal 3 epoxy is warranted against rust and corrosion for 12 years. Removable polymer shelf mats are warranted against corrosion for life.
- Microban® antimicrobial product protection inhibits the growth of mold, mildew and bacteria.
- Durable — polymer shelf mats withstand the rigors of daily use.
- Cleanable — lift off shelf mats are sized to fit in a sink or commercial dish washer making cleaning a snap.

For ordering information, see pages 32-35



# Store it Safe, Keep it Clean, Keep it Organized... MetroMax iQ™ Cold Storage Systems.



## MetroMax Q™

Perfect for meat, produce, deli and dairy coolers or freezers.

- Perfect for Cooler Storage.
- **Corrosion Resistant** — 15 year warranty against rust and corrosion.
- **Microban® Antimicrobial** product protection is built into shelves and all touch points inhibiting the growth of mold, mildew and bacteria.
- **Lift-off shelf mats** make cleaning a snap.
- Built-in levers for easy shelf adjustment.
- Grid and solid shelf mats are available.

For part numbers and accessory selection, see pages 15 and 22-28.



## MetroMax i™

The ultimate solution for damp, cold environments.

- The **BEST SOLUTION** for cooler or freezer storage.
- **Corrosion Proof** — **Lifetime Warranty** against rust and corrosion.
- **Microban® Antimicrobial** product protection is built into shelves and all touch points inhibiting the growth of mold, mildew and bacteria.
- **Lift-off shelf mats** make cleaning a snap.
- Grid and solid shelf mats are available.

For part numbers and accessory selection, see pages 14 and 22-28.





Take advantage  
of our layout and  
design services.

Start the  
process today.

Log on to  
[www.metro.com](http://www.metro.com)  
to locate a  
representative  
near you.

> **"SPACE AUDITS" TO MAXIMIZE YOUR STORAGE POTENTIAL**

We'll measure your space, assess your storage needs and generate a quotation and detailed drawings.

> **PRODUCT PLANNING AND ROOM LAYOUT**

Our team of architectural consultants are ready to support your room layout needs with computer aided drafting. Our drawings take the guess work out of the planning process.

> **PROJECT QUOTING AND MANAGEMENT**

Whether your Metro storage needs are small or you are stocking a complete facility, together our Sales Professionals and their Sales Support and Customer Service teams will work with you to ensure your project is a success.

> **3D PRODUCT AND APPLICATION VISUALIZATION**

With state of the art computer generated imagery, Metro's Sales Support team can help you visualize our products in your space or future space....

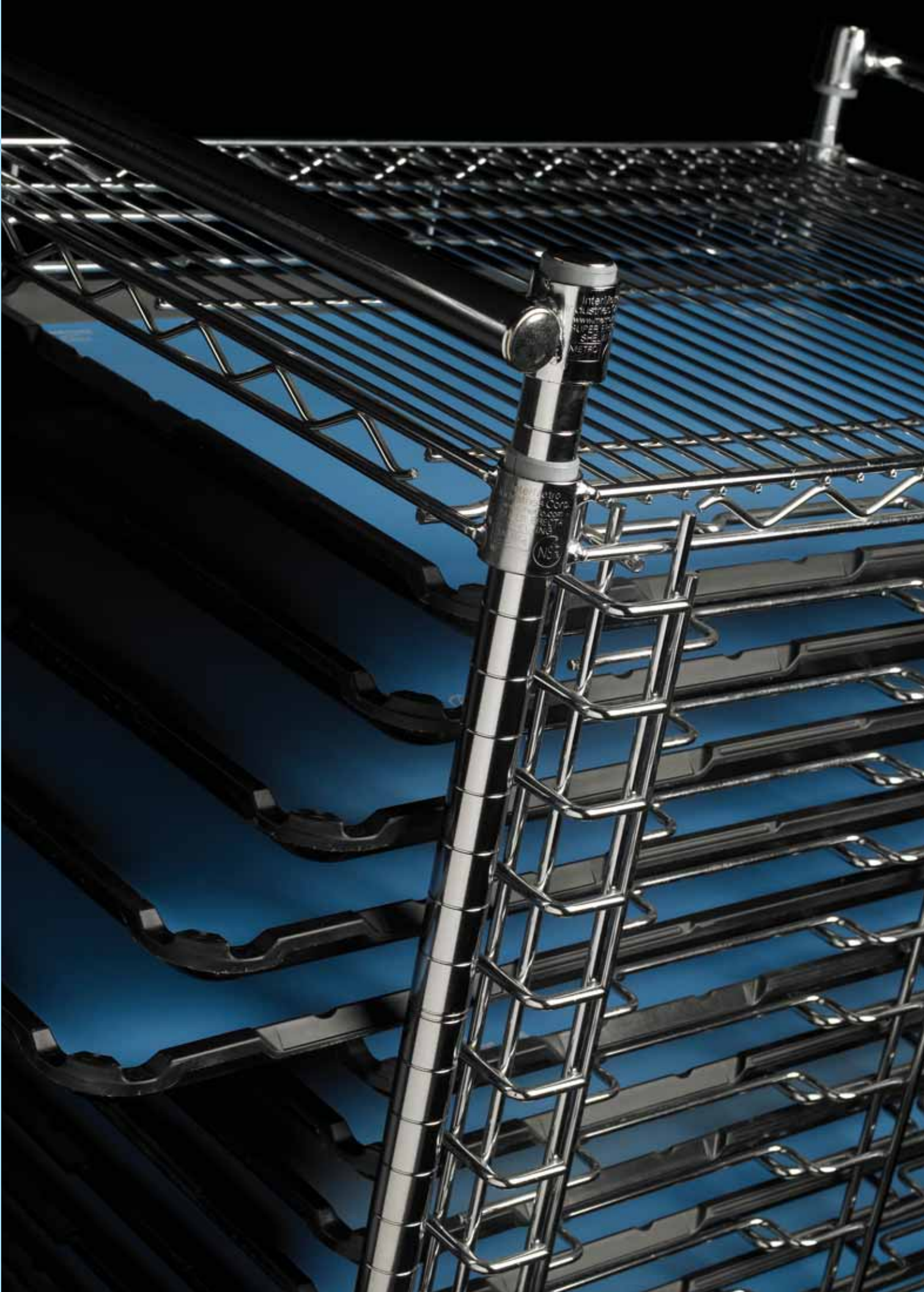

# ELECTRONICS & CLEANROOM PRODUCTS

Carts, Covers & ESD Accessories .....	144-149
PCB Handling .....	150-155
Tote Boxes, Bins & Accessories.....	156-157
Clean Tables, Carts & Gowning Room Products .....	158-163



## Open Starsys™ System

Metro's Open Starsys System is a productivity focused, high-density transport and storage system that adapts to change and provides safe and comfortable access to the material it stores. The optional full-extension shelf offers increased storage capacity compared to standard shelving and carts. Design a unit to fit your needs following the 3 simple steps as provided below.

ESD Classification: Conductive (Stationary and Mobile ESD units only).

### I. Select a Shell

Shells are available in single, double, or triple wide dimensions to accommodate interior shelves, either stationary or full extension. Select your desired shell from the 12 available models below. **Each shell comes complete with top and bottom wire shelves, posts with slotted inserts, footplates (for stationary models) or extended base with 5" (127mm) swivel and brake casters (for mobile models), and necessary hardware. Triple-wide units also include one pair of intermediate posts to create a single wide and double wide bay to accommodate available shelves.**

### Shells

Description	Mobile/ Stationary	High/ Low	Outside Dimensions Depth/Width/Height		Approx. Pkd. Wt.		Cat. No.	Cat. No. ESD*
			(in.)	(mm)	(lbs.)	(kg)		
Single Wide	Stationary	Low	21 <sup>5</sup> / <sub>8</sub> x21 <sup>15</sup> / <sub>16</sub> x44 <sup>13</sup> / <sub>16</sub>	702x557x1138	27	12.2	<b>SXRS450SQ</b>	
Single Wide	Stationary	High	21 <sup>5</sup> / <sub>8</sub> x21 <sup>15</sup> / <sub>16</sub> x72 <sup>3</sup> / <sub>8</sub>	702x557x1838	38	17.2	<b>SXRS720SQ</b>	
Single Wide	Mobile	Low	27 <sup>7</sup> / <sub>8</sub> x22 <sup>11</sup> / <sub>16</sub> x50 <sup>3</sup> / <sub>4</sub>	708x576x1289	65	29.5	<b>SXRS510MQ</b>	<b>SXRS510MQESD</b>
Single Wide	Mobile	High	27 <sup>7</sup> / <sub>8</sub> x22 <sup>11</sup> / <sub>16</sub> x71 <sup>13</sup> / <sub>16</sub>	708x576x1824	106	48.0	<b>SXRS720MQ</b>	<b>SXRS720MQESD</b>
Double Wide	Stationary	Low	21 <sup>5</sup> / <sub>8</sub> x41 <sup>3</sup> / <sub>4</sub> x44 <sup>13</sup> / <sub>16</sub>	702x1060x1138	56	25.4	<b>SXRD450SQ</b>	
Double Wide	Stationary	High	21 <sup>5</sup> / <sub>8</sub> x41 <sup>3</sup> / <sub>4</sub> x72 <sup>3</sup> / <sub>8</sub>	702x1060x1838	66	29.4	<b>SXRD720SQ</b>	
Double Wide	Mobile	Low	27 <sup>7</sup> / <sub>8</sub> x42 <sup>1</sup> / <sub>2</sub> x50 <sup>3</sup> / <sub>4</sub>	708x1080x1289	105	46.7	<b>SXRD510MQ</b>	<b>SXRD510MQESD</b>
Double Wide	Mobile	High	27 <sup>7</sup> / <sub>8</sub> x42 <sup>1</sup> / <sub>2</sub> x71 <sup>13</sup> / <sub>16</sub>	708x1080x1824	118	52.5	<b>SXRD720MQ</b>	<b>SXRD720MQESD</b>
Triple Wide	Stationary	Low	21 <sup>5</sup> / <sub>8</sub> x61 <sup>9</sup> / <sub>16</sub> x44 <sup>13</sup> / <sub>16</sub>	702x1570x1138	55	24.5	<b>SXRT450SQ</b>	
Triple Wide	Stationary	High	21 <sup>5</sup> / <sub>8</sub> x61 <sup>9</sup> / <sub>16</sub> x72 <sup>3</sup> / <sub>8</sub>	702x1570x1838	75	34.0	<b>SXRT720SQ</b>	
Triple Wide	Mobile	Low	27 <sup>7</sup> / <sub>8</sub> x62 <sup>5</sup> / <sub>16</sub> x50 <sup>3</sup> / <sub>4</sub>	708x1583x1289	140	62.3	<b>SXRT510MQ</b>	<b>SXRT510MQESD</b>
Triple Wide	Mobile	High	27 <sup>7</sup> / <sub>8</sub> x62 <sup>5</sup> / <sub>16</sub> x71 <sup>13</sup> / <sub>16</sub>	708x1583x1824	150	68.0	<b>SXRT720MQ</b>	<b>SXRT720MQESD</b>

\*Mobile ESD Units include conductive aluminum shroud and grounding cable. All standard stationary units are ESD safe. All units shown above are shipped knocked-down. Contact your local Metro representative if factory assembly is required.

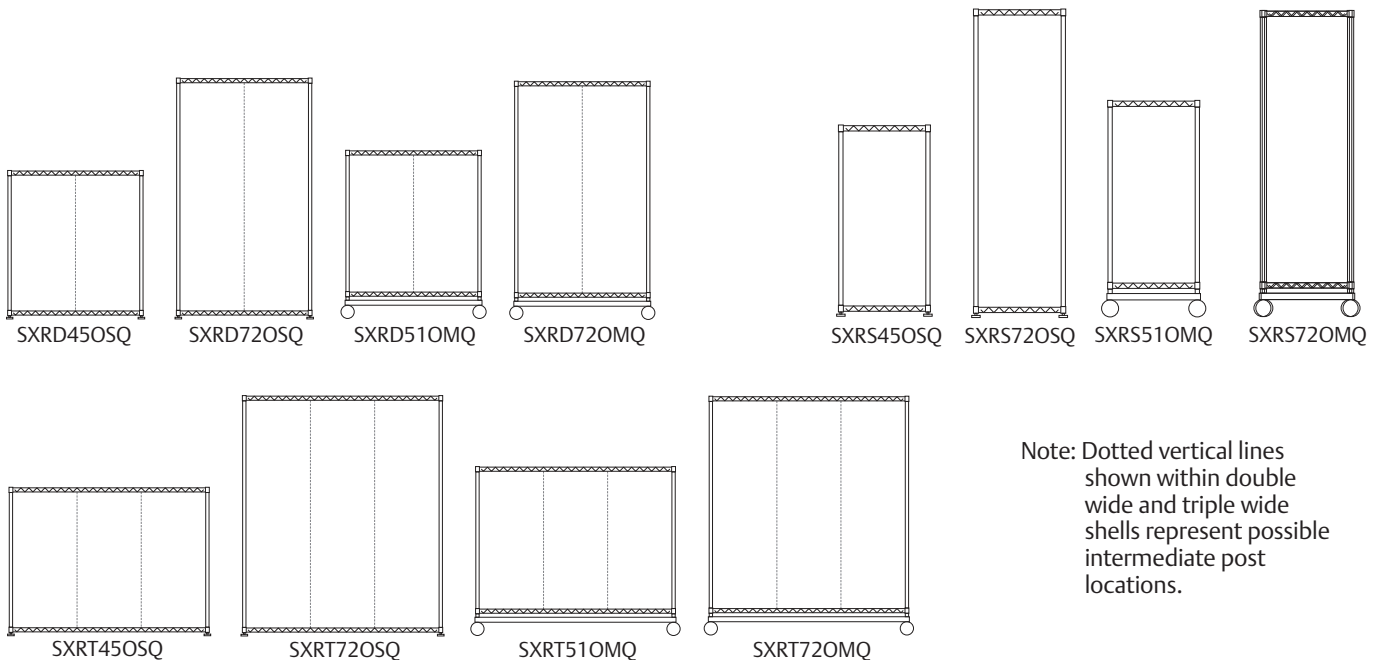

Note: Dotted vertical lines shown within double wide and triple wide shells represent possible intermediate post locations.



## II. Select Desired Configuration

Double and triple wide units (SXRD and SXRT models) may be internally divided into vertical bays to accommodate single or double wide shelves as desired. Two intermediate posts are required between each bay and come with appropriate mounting hardware. Select required intermediate posts as specified below:

- A — One intermediate post required to enclose back of double wide unit if only double wide shelves are being used (2 back panels required).
- B — Two intermediate posts required to divide double wide unit into 2 vertical bays that accommodate single wide shelves.
- C — Two intermediate posts required as standard components with all triple wide units to segment into 1-single wide and 1-double wide vertical bay that accommodates single and double wide shelves as desired.
- D — One additional intermediate post is required to enclose back of triple wide unit with back panels (3 back panels required).
- E — Two additional intermediate posts required on triple wide units to segment into 3-single wide vertical bays that accommodate single wide shelves as desired (3 back panels required if rear enclosure desired).

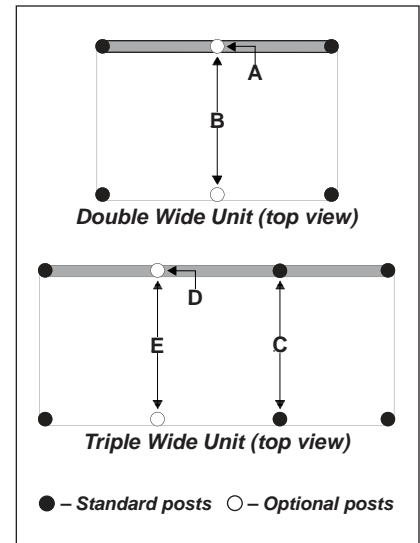

### Intermediate Posts

Description	Fits Shells	Outside Dimensions Length/Diameter		Approx. Pkd. Wt.		Cat. No.
		(in.)	(mm)	(lbs.)	(kg)	
Intermediate Post – Low Units	SXRS45/51, SXR45/51, SXRT45/51	37 <sup>1</sup> / <sub>8</sub> x1 <sup>5</sup> / <sub>8</sub>	943x41.3	3	1.3	<b>SXR37IP</b>
Intermediate Post – High Mobile Units	SXRS72, SXR72, SXRT72 (Mobile)	58x1 <sup>5</sup> / <sub>8</sub>	1473x41.3	3 <sup>1</sup> / <sub>4</sub>	1.4	<b>SXR58IP</b>
Intermediate Post – High Stationary Units	SXRS72, SXR72, SXRT72 (Stationary)	64 <sup>1</sup> / <sub>4</sub> x1 <sup>5</sup> / <sub>8</sub>	1632x41.3	3 <sup>1</sup> / <sub>2</sub>	1.6	<b>SXR65IP</b>

## III. Select Desired Shelves and Accessories (if required)

Shelves are available in stationary or full extension styles that can be installed at any location on a post within a shell at 1" (25.4mm) increments. Stationary shelves include necessary mounting clips and each full-extension shelf includes one pair of shelf glides with a right-hand lock button to prevent shelf movement while mobile. Stationary and full-extension shelves can be utilized together in the same shell.\*

### Shelving

Description	Single Wide/ Double Wide	Weight Capacity <sup>†</sup>		Outside Dimension Depth/Width/Height		Approx. Pkd. Wt.		Cat. No.
		(lbs.)	(kg)	(in.)	(mm)	(lbs.)	(kg)	
Stationary Shelf	Single	150	68	21 <sup>9</sup> / <sub>16</sub> x19 <sup>3</sup> / <sub>4</sub> x1 <sup>15</sup> / <sub>16</sub>	548x502x33	10	4.5	<b>SXR50Q-KD</b>
Stationary Shelf	Double	300	136	21 <sup>9</sup> / <sub>16</sub> x39 <sup>1</sup> / <sub>2</sub> x1 <sup>15</sup> / <sub>16</sub>	548x1003x33	20	9.0	<b>SXR100Q-KD</b>
Full Extension Shelf	Single	60	27.2	21 <sup>9</sup> / <sub>16</sub> x16 <sup>1</sup> / <sub>2</sub> x1 <sup>1</sup> / <sub>2</sub>	548x419x38	12	5.4	<b>SXR419Q-KD</b>
Full Extension Shelf	Double	125	56.6	21 <sup>9</sup> / <sub>16</sub> x36 <sup>3</sup> / <sub>8</sub> x1 <sup>15</sup> / <sub>16</sub>	548x924x33	22	10.0	<b>SXR924Q-KD</b>

<sup>†</sup>Weight capacities shown are based on uniformly distributed loads.

\*Full-extension shelves can be positioned within a unit up to, and including, a maximum height of 48" (1219mm) above the floor. Only one shelf of the equipment opened at any one time; excluding transport, where all shelves should be closed and the locking mechanism engaged.

### Accessories

Description	All Internal Shelves**	Outside Dimensions Depth/Width/Height		Approx. Pkd. Wt.		Cat. No.
		(in.)	(mm)	(lbs.)	(kg)	
Ledge	All Internal Shelves**	15 <sup>1</sup> / <sub>4</sub> x2 <sup>3</sup> / <sub>4</sub> x4 <sup>1</sup> / <sub>8</sub>	387x19x105	2	0.9	<b>SXRSLDG*</b>
Divider	All Internal Shelves**	21x5 <sup>5</sup> / <sub>8</sub> x3	533x17x76	2 <sup>1</sup> / <sub>2</sub>	1.1	<b>SXRSLDIV</b>

\*Note: Ledge can be used as both a back and a side ledge. For use as a back ledge, order same number of ledges as width of shelf (e.g., single wide = 1, double wide = 2). Ledge not functional as side ledge on full-extension shelves.

\*\*Note: Ledge and divider accessories may be used with ESD Units.



SXRSLDG Ledge



SXRSLDIV Divider



SXR924Q Stationary Wire Shelf



SXR419Q Stationary Wire Shelf



Benchside Cart with Grounding Cable. Metro tote boxes sold separately, See page 146.

**Benchside Cart — 16.70**

Metro's Benchside Tote Cart allows workers to position bins, totes, cartons, boxes, or sub-assemblies at an angle conducive to repetitive pick-and-place operations. Each unit comes with a 45° slanted top shelf, standard Super Erecta Shelf at bottom, four casters (two with brakes), conductive plastic split sleeves, and a grounding cable.

- Positions totes, boxes, or sub-assemblies at an angle conducive to efficient pick-and-place operation
- Accommodates miscellaneous totes, cartons, or other items
- Uses minimal amount of available floor space
- Offers easy mobility and holds cart stationary at desired location
- Provides for dissipation of electrostatic charges

ESD Classification: Conductive

Width (in.) (mm)		Length (in.) (mm)		Height (in.) (mm)		Approx. Pkd. Wt. (lbs.) (kg)		Cat. No.
18	457	24	610	39	991 (Rear)	39	17.7	<b>EBC313BBR</b>
				30	760 (Front)			



ESD Cart Cover

**ESD Covers — 51.14**

Metro's ESD Cart Covers provide an effective method of controlling electrostatic discharge while protecting cart contents from contamination and moisture.

- Unique slip resistant texture.
- Metro's ESD Cart Covers leave no black carbon residue and clean easily with mild detergents and water and are flame retardant and resist the growth of bacteria, fungus, and mildew.
- All ESD Covers include a flap on one side, zipper closures, and a paperwork pouch sized to accommodate 8 1/2"x11" (216x279mm) documents.

ESD Classification: Conductive outer surface and static dissipative inner surface.

Fits Shelf Size (in.) (mm)		Post Height (in.) (mm)		Weight (lbs.) (kg)		Cat. No.
18x36	355x914	63	1600	3.5	1.54	<b>18X36X62ESD</b>
18x48	355x1219	63	1600	4.5	2.04	<b>18X48X62ESD</b>
24x24	610x610	63	1600	3.0	1.36	<b>24X24X62ESD</b>
24x36	610x914	63	1600	4.5	2.04	<b>24X36X62ESD</b>
24x48	610x1219	63	1600	6.0	2.72	<b>24X48X62ESD</b>
24x60	610x1524	63	1600	7.5	3.40	<b>24X60X62ESD</b>

**Static Discharge Classifications**

All items shown in this catalog with an ESD classification of **conductive** or **static dissipative** conform to the standards and testing procedures as prescribed per: EIA Standard 541, MIL-HDBK-263A and EOS/ESD-S11.11-1993.

These classifications are dependent upon the proper combination of products as specified throughout this catalog. If modifications to a standard unit are required to make it ESD safe, it will be noted in the ESD Classification section.

Stem Casters — **11.20** **9.05**

Use with Super Erecta®/Super Adjustable™ posts (shown below) to meet your special needs. Each caster comes with a donut bumper at no extra charge. 5MDA series provides extra shock absorption while the 5MP series is long-wearing and resists abrasion. 5M series is the most economical caster offered. 5MFA series are designed to dampen vibration and offer superior rollability and maneuverability.

ESD Classification: Non-Conductive

Wheel Diameter		Face		Load Rating		Type	Wheel Tread Material	Approx. Pkd. Wt.		Cat. No. Super Erecta
(in.)	(mm)	(in.)	(mm)	(lbs.)	(kg)			(lbs.)	(kg)	
5	127	1 1/4	32	200	90	Stem/Swivel	Resilient	2 1/2	1.1	<b>5M</b>
5	127	1 1/4	32	200	90	Stem/Brake	Resilient	2 3/4	1.2	<b>5MB</b>
5	127	1 1/4	32	250	111	Stem/Swivel	High Modulus Donut	2 1/2	1.1	<b>5MDA</b>
5	127	1 1/4	32	250	111	Stem/Brake	High Modulus Donut	2 5/8	1.17	<b>5MDBA</b>
5	127	1 1/4	32	300	135	Stem/Swivel	High Modulus	2 1/2	1.1	<b>5MFA</b>
5	127	1 1/4	32	300	135	Stem/Brake	High Modulus	2 3/4	1.2	<b>5MFBA</b>
5	127	1 1/4	32	300	135	Stem/Swivel	Polyurethane	2 1/8	.94	<b>5MP</b>
5	127	1 1/4	32	300	135	Stem/Brake	Polyurethane	2 1/4	1	<b>5MPB</b>

Note: Load Height for all casters — 63/32" ±1/16" (155±1.5mm).



5M



5MDA

Super Erecta Conductive Stem Casters — **11.21**

When used in conjunction with aluminum split sleeves and a grounding cable, Metro's conductive casters ensure mobile units are properly grounded to ESD floor surfaces. New 5MESD series are non-carbon loaded and will not mark expensive ESD floors.

ESD Classification: Conductive

Wheel Diameter		Face		Load Rating		Type	Approx. Pkd. Wt.		Cat. No.
(in.)	(mm)	(in.)	(mm)	(lbs.)	(kg)		(lbs.)	(kg)	
5	127	1 1/4	32	175	79	Stem/Swivel	2 1/2	1.1	<b>5MC</b>
5	127	1 1/4	32	175	79	Stem/Brake	2 3/4	1.2	<b>5MBC</b>
5	127	1 1/4	32	200	91	Stem/Swivel	2 1/2	1.1	<b>5MESD</b>
5	127	1 1/4	32	200	91	Stem/Brake	2 3/4	1.2	<b>5MBESD</b>

Note 1: Load Height for all casters — 6 3/32" ±1/16" (155±1.5mm).

Note 2: Brakes are foot-operated for 5MC series

Note 3: Brakes are toe-operated for 5MESD series.



5MFA

Super Erecta®/Super Adjustable™ SiteSelect™ Posts for Stem Casters — **10.01a**

Provided without leveling bolt assembly to accept stem casters.

Height		Approx. Pkd. Wt.		Cat. No. Plated	Cat. No. Stainless
(in.)	(mm)	(lbs.)	(kg)		
33 7/8	861	2	0.9	<b>33UP</b>	<b>33UPS</b>
54	1370	3	1.4	<b>54UP</b>	<b>54UPS</b>
62	1575	3 1/2	1.6	<b>63UP</b>	<b>63UPS</b>
74	1880	4	1.8	<b>74UP</b>	<b>74UPS</b>
86	2185	5	2.3	<b>86UP</b>	<b>86UPS</b>



Site-Select™ Posts are grooved at 1" (25mm) increments and numbered at 2" (50mm) increments. Posts are multi-grooved every 8" (203mm) for easy shelf location.



APT1C-5MP  
(Shown with optional "Extra Slides" and Metro Dividers Boxes)

Kitting Carts — 51.07

Metro Kitting Carts provide efficient handling of totes, PCB carriers, trays, or other material handling containers. Totes for use with these carts may be found on page 156, and PCB carriers on page 151.

- Available in single, double, or triple bay configurations.
- Available with 2-brake and 2-swivel casters in your choice of resilient rubber or polyurethane tread.

ESD Classification: Non-Conductive (Units can be made conductive by utilizing GCB165 grounding bracket and ASK165 grounding cable found on page 149).

(in.)	Width/Length		Height		Casters	Approx. Pkd. Wt.		Cat. No.
	(in.)	(mm)	(in.)	(mm)		(lbs.)	(kg)	
<b>Single-Bay</b>								
26x22 <sup>5</sup> / <sub>8</sub>		660x574	68	1727	Resilient	56	25.2	PT1C-5M*
26x22 <sup>5</sup> / <sub>8</sub>		660x574	68	1727	Polyurethane	56	25.2	PT1C-5MP*
<b>Adjustable Single-Bay</b>								
26x20 <sup>3</sup> / <sub>8</sub> to 29 <sup>3</sup> / <sub>8</sub>	523 to 746	660x660	68	1727	Resilient	54	24.3	APT1C-5M
26x20 <sup>3</sup> / <sub>8</sub> to 29 <sup>3</sup> / <sub>8</sub>	523 to 746	660x660	68	1727	Polyurethane	54	24.3	APT1C-5MP
<b>Double-Bay</b>								
26x41 <sup>3</sup> / <sub>4</sub>		660x1060	68	1727	Resilient	73	32.8	PT2C-5M**
26x41 <sup>3</sup> / <sub>4</sub>		660x1060	68	1727	Polyurethane	73	32.8	PT2C-5MP**
<b>Triple-Bay</b>								
26x60 <sup>7</sup> / <sub>8</sub>		660x1545	68	1727	Resilient	117	52.6	PT3C-5M***
26x60 <sup>7</sup> / <sub>8</sub>		660x1545	68	1727	Polyurethane	117	52.6	PT3C-5MP***

\*Single-bay carriers are equipped with six S3C single slides (3 sets).  
 \*\*Double-bay carriers are equipped with six S3C single slides (3 sets) and three S4C double slides.  
 \*\*\*Triple-bay carriers are equipped with six S3C single slides (3 sets) and six S4C double slides (3 sets).  
 Also available without slides. Order with catalog numbers PTN1, PTN2, PTN3.



PT2C-5M  
(Shown with optional Metro Divider Boxes)

Extra Slides

(in.)	Width/Length		Description	Approx. Pkd. Wt.		Cat. No.
	(in.)	(mm)		(lbs.)	(kg)	
1 <sup>3</sup> / <sub>16</sub> x24	17x610	Combination Single Slide	1.5	.67	S3C	
1 <sup>3</sup> / <sub>16</sub> x24	17x610	Combination Double Slide	1.6	.72	S4C	
		End Stops for the S3C Slide			9950Z	



PT3C-5M  
(Shown with optional Metro Divider Boxes)

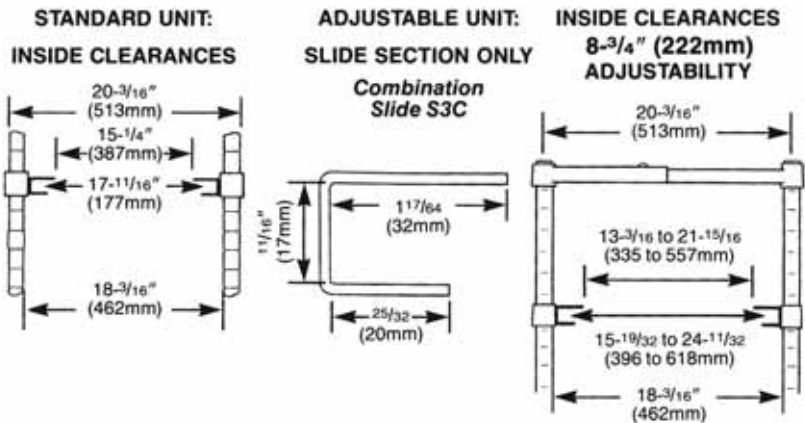

## SMT Reel Shelving (Super Erecta) — 51.09

Metro's Super Erecta-based SMT Component Reel Shelving offers an efficient method of storage and transport for standard size component reels. These Super Erecta Brite plated shelves can be mixed and matched with standard Super Erecta shelving, posts, and casters to create a reel handling and storage system to address the exacting needs of PCB manufacturers.

ESD Classification: Conductive with the use of conductive plastic split sleeves (see below), and 5MESD conductive casters for mobile applications (found on page 147).

Width (in.) (mm)	Length (in.) (mm)	Height		Handles Reel Sizes		Reel* Capacity	Compartment Opening (I.D.)		Approx. Pkd. Wt.		Cat. No.		
		(in.)	(mm)	(in.)	(mm)		(in.)	(mm)	(lbs.)	(kg)			
18	457	36	914	3.75	95	7	178	78	.625	27	11.0	5	R1836BR-7
18	457	36	914	4.25	108	10	254	15	2	50	7.5	3.4	R1836BR-13

Note 1: Capacity given is per shelf.

Note 2: Capacity shown assumes standard reels (per EIS standards) are used. As the widths of these reels vary, capacity may increase if multiple reels can be fit into single compartments. Refer to Compartment Opening column above to determine actual capacity.



Reel Shelving

## ESD Label Holders — 51.20 51.35

Conductive label holders, for use with Super Erecta® wire shelves and open MetroMax Q ESD frames, are available in 3" (76mm) and 37" (940mm) lengths.

Cat. No. **9990PESD** (3" [76mm] long)



9990PESD

Cat. No. **9990P6ESD** (37" [940mm] long)

## Super Erecta Conductive Plastic Split Sleeves — 51.15

Required for Super Erecta Shelving ESD applications. Four sets of sleeves to a bag. Cat. No. **9985-ESD**



9985-ESD



9986Z

## Super Adjustable™ ESD Kits (not shown) — 51.15

For ESD protected environments. Kit includes conductive releases (4), wedges (4), and sleeves (4). Cat. No. **AESDA2-KIT**

Super Adjustable™ Conductive Sleeves. Set of 4. Cat. No. **AESDA2-4**

## Aluminum Split Sleeves — 10.06

Required for Super Erecta Shelving over-the-road applications and high temperature situations (+120°F).

Description	Cat. No.
Aluminum Split Sleeves with Zinc Rings	<b>9986Z</b>
Aluminum Split Sleeves with Stainless Rings	<b>9986S</b>

## Conductive Cart Covers — 51.14 51.35

Recommended for protection and cleanliness of ESD sensitive materials on Metro Super Erecta carts. For available sizes and model numbers see pages 146 and 154.

## Grounding Cable — 51.20

Provides an effective method of electrostatic discharge for any Metro Super Erecta unit (stationary or mobile) when used in conjunction with aluminum split sleeves or ESD kit and conductive casters (page 147). Metro's Grounding Cables ensure a proper path to ground when used with ESD flooring.

Cat. No. **ASKCR** (screws onto wire snake frame)



ASKCR

Cat. No. **ASK16S** (spring-loaded clamp attachment)



ASK16S

## Grounding Cable and Universal Bracket (not shown) — 51.20

Universal bracket fits wire and solid shelves, as well as open-wire frames. Cat. No. **GCB16SA**

## Grounding Cable and Bracket (not shown) — 51.20

Allows grounding of Metro units with a tubular frame at the bottom level (e.g. Metro Kitting Carts and Benchside PCB Truck models). Cat. No. **GCB16S**

See page 147 for Conductive Casters.



Horizontal Hold (CBH) Benchside Model

Horizontal Hold Carts — Standard-Duty (CBH Style) — **51.03**

Safety and convenience are provided in this durable mobile unit.

- Adjustable panels with horizontal slides feature  $\frac{5}{8}$ " (13mm) spacing for high-density loading.
- Ideal for transporting work-in process and storing large quantities of boards.
- Open chrome-plated steel panels allow for airflow and conductivity, and have slides that accept boards up to  $\frac{1}{8}$ " (3mm) thick.
- Standard units include 2 end panels only. Optional center panel shown below.

ESD Classification: Conductive

Benchside Models

Maximum Board Size		Capacity Full-Size Boards	Capacity 11 $\frac{1}{2}$ "	Capacity 11 $\frac{1}{2}$ "	Width/Length		Height		Approx. Pkd. Wt.		Cat. No.
(in.)	(mm)		Boards without Center Panel	Boards with One Center Panel	(in.)	(mm)	(in.)	(mm)	(lbs.)	(kg)	
22 $\frac{1}{2}$ x30 $\frac{1}{4}$	571x768	53	106	212	24x36	610x914	50	1270	81	36.4	<b>CBH534BC</b>
22 $\frac{1}{2}$ x42 $\frac{1}{4}$	571x1073	53	106	212	24x48	610x1219	50	1270	85	38.2	<b>CBH554BC</b>

Double-Sided Center Panel for CBH Horizontal Hold Carts

(Includes one stop bar, knobs, and holding brackets).

Width		Height		Thickness Outside/Inside		Approx. Pkd. Wt.		Cat. No.
(in.)	(mm)	(in.)	(mm)	(in.)	(mm)	(lbs.)	(kg)	
24	610	41	1041	1 $\frac{1}{4}$ x1 $\frac{15}{16}$	31.7x20.5	22	9.9	<b>CBHP2</b>

Horizontal Hold Carts — Heavy-Duty (CBL Style) — **51.03**

High-density cart with  $\frac{3}{8}$ " (8mm) deep slides for positive board capture provide 48 levels for circuit boards and  $\frac{11}{16}$ " (18mm) on center spacing for volume loading. Standard units include two end, and one center panel. Height: 68" (1727mm).

- Center panel (included) features slides on both sides.
- Slides accept boards up to 22 $\frac{1}{2}$ " (571mm) long and up to  $\frac{1}{2}$ " (12.7mm) thick.

ESD Classification: Conductive



Horizontal Hold (CBL) Model

Maximum Board Size w/o Center Panel		Capacity 11 $\frac{1}{2}$ "	Capacity 11 $\frac{1}{2}$ "	Width/Length		Approx. Pkd. Wt.		Cat. No.
(in.)	(mm)	Boards without Center Panel	Boards with Center Panel	(in.)	(mm)	(lbs.)	(kg)	
22 $\frac{1}{2}$ x30 $\frac{1}{4}$	571x768	96	192	24x36	610x914	105	47.2	<b>CBL536BC</b>
22 $\frac{1}{2}$ x42 $\frac{1}{4}$	571x1073	96	192	24x48	610x1219	120	54.1	<b>CBL556BC</b>

Double-Sided Center Panel for CBL Horizontal Hold Carts

Width/Length		Height		Approx. Pkd. Wt.		Cat. No.
(in.)	(mm)	(in.)	(mm)	(lbs.)	(kg)	
23 $\frac{1}{2}$ x37 $\frac{1}{4}$	596x946	1 $\frac{5}{8}$	40.6	24	10.8	<b>CBLP2</b>

High-Temperature Kit

Description	Approx. Pkd. Wt.		Cat. No.
	(lbs.)	(kg)	
High-Temperature Kit (Includes 4 high-temperature casters (two with brakes), two "Caution Hot" labels, and 4 metal post caps. Required for temperatures over 160°F (70°C). Kit good to 400°F (205°C). Label Identification Kit (Contains two labels)	13	5.8	<b>HTK-1</b> <b>IDK-1V</b>

**PCB Hand-Held Carriers — 51.05**

The safe, efficient way to carry delicate printed circuit boards. System features adjustable panels with 5/8" (13mm) slide spacing that accommodate boards up to 1/8" (9mm) thick. Hi-temperature phenolic knobs can be used in applications with up to 400°F [204°C] continuous temperatures.

- Units carry up to 20 full-size boards; optional double-sided center panels increase capacity of carriers.
- Three width sizes available to accommodate additional center panels.
- Stackable design permits up to three carriers of the same size to be stacked vertically, saving floor space.
- Units can be transported and stored on Metro® Kitting Carts found on page 148.

ESD Classification: Conductive

Width/Length (in.) (mm)	Height (in.) (mm)	Maximum Board Size (in.) (mm)	Capacity Full-Size Boards	Capacity with 12"x6" (305x150mm) Boards and Optional Center Panels	Approx. Pkd. Wt. Per Unit (lbs.) (kg)	Cat. No.
12 1/2x17 1/2 315x445	18 3/16 460	13x12 330x305	20	40 (1 Center Panel)	10 4.5	<b>CBC11C</b>
12 1/2x24 1/4 315x615	18 3/16 460	19 1/4x12 490x305	20	60 (2 Center Panels)	10 3/4 4.8	<b>CBC13C</b>



PCB Hand-Held Carrier

**Double-Sided Center Panels for PCB Carriers**

Width/Length (in.) (mm)	Height (in.) (mm)	Approx. Pkd. Wt. (lbs.) (kg)	Cat. No.
12 1/2x2 7/8 315x20.3	15 1/8 385	6 2.7	<b>CBCP2C</b>

**PCB Handling Accessories for Metro Containers — 16.65**

Quickly and easily convert your Metro totes (found on pages 156-157) into an effective PCB handling system with the addition Metro PCB Grid Boards.

**Metro PCB Grid Boards**

Place inside standard Metro totes to provide a pattern of slots where boards can be captured by the bottom edge. Three different size PCB Grid Boards are available in both Bentron conductive and Benstat static dissipative materials to fit the TB91000, TB92000, and TB93000 series footprints.

Fits Series #	Length (in.) (mm)	Width (in.) (mm)	Depth (in.) (mm)	Slot Rows Length/Width (mm)	Cat. No.*
TB91000	8 7/8 225	6 3/8 165	5/8 13	12x17 305x432	<b>GB91005</b>
TB92000	14 5/16 364	9 229	5/8 13	17x29 432x736	<b>GB92005</b>
TB93000	20 508	17 7/8 454	5/8 13	29x39 736x990	<b>GB93005</b>

\*Add appropriate material suffix (BAS-Benstat or CAS-Bentron). For example, GB91005BAS.

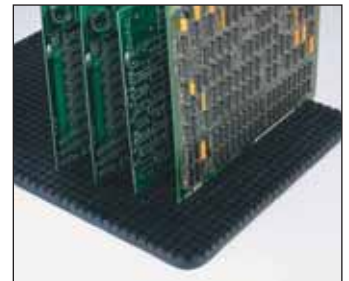

PCB Grid Board



PCB Grid Board in Metro Tote



SmartTray™ features barcoding and color coding, and stacks with other trays of the same footprint.



SmartTray™ engages with wire cart design to provide optimum ergonomic access.

### SmartTray™ System

Designed to maximize productivity by accelerating throughput, minimizing PCB handling damage and providing superior ESD protection. The 18"x26" (457x660mm) footprint handles multiple-sized boards.

- The ESD-safe SmartTray facilitates efficient tracking of work-in-process and finished goods with the use of bar code technology.
- Supports lean manufacturing by offering color-coding accessories that clearly identify trays and carts.
- Molded from Metrostat,™ a material offering premium ESD protection.
- SmartTray fits all Metro tray cart systems as well as competitive bottom-loaded models and most tray based cart systems in today's marketplace.

### SmartTray Cart System — 51.35

Cat. No. **CBNTC20M**  
(shown with accessories)







SmartTray™ System — 51.35

- Shelves, posts, slides, handles and stop bars: ESD safe, chrome-plated finish.
- Casters: 5" (127mm) stem/swivel vibration suppression casters (5MFA series). Two brake, two swivel casters.

SmartTray Cart Solutions (cart with trays and tray inlays)

- Choose between Metro's premium two-layer tray inlay or the economy inlay (see ESD Tray Inlay section below for more information).

Description	Tray Inlay Type*	Tray Capacity	Slide Spacing (mm)		Width/Length (mm)		Height (mm)		Approx. Pkd. Wt. (lbs./kg)		Cat. No.
Front-load cart with SmartTrays (20) and tray inlays (20)	Premium	20	1 <sup>3</sup> / <sub>4</sub>	44	28x22	711x559	49	1245	160	72.5	CBNTC20MSOL1
Front-load cart with SmartTrays (30) and tray inlays (30)	Premium	30	1 <sup>3</sup> / <sub>4</sub>	44	28x22	711x559	63	1600	217	98	CBNTC30MSOL1
Side-load cart with SmartTrays (20) and tray inlays (20)	Premium	20	1 <sup>3</sup> / <sub>4</sub>	44	22x30	559x762	49	1245	160	72.5	CBNTCS20MSOL1
Front-load cart with SmartTrays (20) and tray inlays (20)	Economy	20	1 <sup>3</sup> / <sub>4</sub>	44	28x22	711x559	49	1245	160	72.5	CBNTC20MSOL2
Front-load cart with SmartTrays (30) and tray inlays (30)	Economy	30	1 <sup>3</sup> / <sub>4</sub>	44	28x22	711x559	63	1600	217	98	CBNTC30MSOL2
Side-load cart with SmartTrays (20) and tray inlays (20)	Economy	20	1 <sup>3</sup> / <sub>4</sub>	44	22x30	559x762	49	1245	160	72.5	CBNTCS20MSOL2

Note: Refer to Tray Inlay and SmartTray section below for technical and electrical property information

Metrostat SmartTray™

Description	Color	Maximum Load Rating (lbs./kg)		Outside Dimensions Width/Length (in./mm)		Inside Dimensions Width/Length (in./mm)		Height (in./mm)		Approx. Pkd. Wt. (lbs./kg)		Cat. No.
ESD molded fiberglass tray	Black	150	68	25 <sup>3</sup> / <sub>4</sub> x17 <sup>3</sup> / <sub>4</sub>	654x451	23 <sup>15</sup> / <sub>16</sub> x15 <sup>15</sup> / <sub>16</sub>	608x405	1 <sup>1</sup> / <sub>8</sub>	28.6	3	1.36	CBNTC-MTRAY

- Note 1: Tray load rating shown above is based on evenly distributed load in conveyor applications.
- Note 2: SmartTrays stack efficiently by themselves, as well as with competitive tray designs of the same dimension.
- Note 3: SmartTrays are compatible with all bottom-loaded tray based cart systems, both Metro and non-Metro.
- Note 4: SmartTrays can be personalized with a company logo. Minimum quantities and extended lead times apply. Contact your Metro Representative for more information.

CBNTC-MTRAY Electrical Properties

Property	Test Method	Value
RTT Resistance	ESD S4.1-1997	1.8x10 <sup>5</sup> -1.4x10 <sup>7</sup> Ohms
RTG Resistance	ESD S4.1-1997	1.4x10 <sup>6</sup> -2.8x10 <sup>6</sup> Ohms
Surface Resistivity	ANSI/EOS/ESD-S11.11-1993	1.0x10 <sup>6</sup> -9.9x10 <sup>9</sup> Ohms/Sq.

ESD Tray Inlays

Description	Color	Width/Length (in./mm)		Thickness (in./mm)		Approx. Pkd. Wt. (lbs./kg)		Cat. No.
Premium rubber inlay, two layer	Blue (topside)/ Black (bottomside)	24.125x16.1	612x410	0.06	1.5	1.5	0.68	CBTC-INLAY01*
Economy vinyl inlay, single-layer	Blue	24x16.125	610x410	0.125	3	1.5	0.68	CBNTC-INLAY02**

\*CBTC-INLAY01 offers maximum ESD protection, as well as superior resistance to heat, abrasion, and chemicals. The soft dissipative top layer makes it ideal for use in soldering and assembly areas. Easy to clean and maintain.

\*\*CBNTC-INLAY02 provides soft-surface inlay for cushioned PCB transport. Inlay provides static dissipative ESD protection. Not recommended for use in soldering and assembly applications.

CBTC-INLAY01 Electrical Properties

Property	Test Method	Value
RTT Resistance	ESD S4.1-1997	4.6x10 <sup>6</sup> -9.0x10 <sup>6</sup> Ohms
RTG Resistance	ESD S4.1-1997	2.3x10 <sup>6</sup> -4.7x10 <sup>6</sup> Ohms

CBNTC-INLAY02 Electrical Properties

Property	Test Method	Value
RTT Resistance	ESD S4.1-1997	1.2x10 <sup>7</sup> -9.0x10 <sup>7</sup> Ohms
RTG Resistance	ESD S4.1-1997	1.4x10 <sup>7</sup> -2.0x10 <sup>7</sup> Ohms

SmartTray Carts

Description	Tray Capacity No.	Slide Spacing (in./mm)		Width/Length (in./mm)		Height (in./mm)		Approx. Pkd. Wt. (lbs./kg)		Cat. No.
Front-Load Cart (short)	20	1 <sup>3</sup> / <sub>4</sub>	44	28x22	711x559	49	1245	80	36	CBNTC20M
Front-Load Cart (tall)	30	1 <sup>3</sup> / <sub>4</sub>	44	28x22	711x559	63	1600	97	44	CBNTC30M
Side-Load Cart	20	1 <sup>3</sup> / <sub>4</sub>	44	22x30	559x762	49	1245	80	36	CBNTCS20M

- Note: CBNTC20M and CBNTCS20M are each load rated at 25 lbs. per level/500lbs. per cart. CBNTC30M is load rated at 20 lbs. per level/600 lbs. per cart.
- Note: Each cart comes complete with 4 vibration suppression casters (2 brake/2 swivel), a grounding cable, 2 push handles (except CBNTC30M), and 2 stop bars.



ESD Cart Covers

SmartTray™ Accessories — **51.35**

ESD Cart Covers

Conductive on the outside and static dissipative on the inside. Cover material is durable and comes standard with brass zippered front flap and side paperwork pouch.

Cat. No. **CBNTC-CC20**

Fits SmartTray Cart #CBNTC20M

Cat. No. **CBNTC-CC30**

Fits SmartTray Cart #CBNTC30M

Cat. No. **CBNTC-CCS20**

Fits SmartTray Cart #CBNTCS20M



ESD Label Holder

ESD Label Holders — **51.15**

Conductive label holders, for use with wire shelves and open MetroMax Q ESD frames, are available in 3" (76mm) and 37" (940mm) lengths.

Cat. No. **9990PESD** (3" [76mm] long)

Cat. No. **9990P6ESD** (37" [940mm] long)



ESD Paperwork Basket

ESD Paperwork Basket

Store work order information, inspection record and other accompanying documentation in this convenient, durable and ESD-safe basket. Easy-on, easy-off design. Not recommended for use with ESD Cart Covers. Measures 13.375"Lx5"Wx7"H (340x127x178mm).

Cat. No. **H209C**

Color Shelf Markers

Designed to color code cart.

Tan — Cat. No. **CSM6-T** 

Red — Cat. No. **CSM6-R** 

White — Cat. No. **CSM6-W** 

Yellow — Cat. No. **CSM6-Y** 

Blue — Cat. No. **CSM6-B** 

Green — Cat. No. **CSM6-G** 



Color Shelf Markers

Color Markers measure 6"Lx1.25"H (152x32mm). Order in units of one.

## End Load and Side Load Wire Tray Carts — 13.42

Economical solution for storage and transport of trays. End-load models provide a large tray landing area, side-load models are highly space efficient. Choice of 1 1/2" (38mm) spacing (38 pans) or 3" (76mm) (20 pans) spacing. UPS shippable, quick, easy no-tool assembly, rolls easily on 5" (127mm) swivel casters. Durable Super Erecta Brite™ finish.

ESD Classification: Non-Conductive (Units can be made conductive with use of 1 bag of conductive plastic split sleeves per shelf and a grounding cable or conductive casters as found on pages 147 and 149).



Wire Tray Racks

Width/Length (in.) (mm)		Height (in.) (mm)		Slide Spacing (in.) (mm)		Pan Capacity Size			Approx. Pkd. Wt. (lbs.) (kg)		Description	Cat. No.		
No.	(in.)	(mm)	No.	(in.)	(mm)	No.	(in.)	(mm)	(lbs.)	(kg)				
21 3/4	27	552	685	69	1752	1 1/2	38	38	18x26	457x660	61	27.7	End-Load	RE1
21 3/4	27	552	685	69	1752	3	76	19	18x26	457x660	70	31.8	End-Load	RE3
19 1/2	30	495	762	69	1752	1 1/2	38	38	18x26	457x660	61	27.6	Side-Load	RS1
19 1/2	30	495	762	69	1752	3	76	19	18x26	457x660	70	31.8	Side-Load	RS3

### Accessories

Description	Model
3 1/2" (90mm) Diameter Rubber Donut Bumper	9992DB
5 1/2" (140mm) Diameter Rubber Donut Bumper	9992N

## Side Load “Knock Down” Carts — 13.72

Pass-Thru design allows loading and unloading from either side.

ESD Classification: Non-Conductive (Units can be made conductive with use of 1 bag of conductive plastic split sleeves per shelf and a grounding cable or conductive casters as found on pages 147 and 149).

Width/Height/Depth (in.) (mm)		Inside Height (in.) (mm)		Slide Spacing (in.) (mm)		Pan Capacity Size			Approx. Pkd. Wt. (lbs.) (kg)		Cat. No.			
No.	(in.)	(mm)	No.	(in.)	(mm)	No.	(in.)	(mm)	(lbs.)	(kg)				
28 3/8	64 1/8	721	1628	476	56 1/2	1435	3	76	18	18x26	457x660	40	18	RT3318N
28 3/8	64 1/8	721	1628	476	56 1/2	1435	5	127	11	18x26	457x660	38	17.1	RT3511N

Note: 5" (127mm) swivel casters, two with brakes, are standard on units listed above. Rack packaged in one box and UPS shippable.



Side Load Cart

## End Load “Knock Down” Carts — Single Section — 13.70

Pass-Thru design allows loading and unloading from either side.

ESD Classification: Non-Conductive (Units can be made conductive with use of 1 bag of conductive plastic split sleeves per shelf and a grounding cable or conductive casters as found on pages 147 and 149).

Width/Height/Depth (in.) (mm)		Inside Height (in.) (mm)		Slide Spacing (in.) (mm)		Pan Capacity Size			Approx. Pkd. Wt. (lbs.) (kg)		Cat. No.			
No.	(in.)	(mm)	No.	(in.)	(mm)	No.	(in.)	(mm)	(lbs.)	(kg)				
20 3/8	64 1/8	518	1630	711	55 7/8	1417	3	76	18	18x26	457x660	53	23.8	RT183N
									or 36	14x18	355x457			
20 3/8	64 1/8	518	1630	711	55 7/8	1417	5	127	11	18x26	457x660	50	22.5	RT115N
									or 22	14x18	355x457			
20 3/8	64 1/8	518	1630	711	55 7/8	1417	1 1/2	28	34	18x26	457x660	55	24.7	RT1334N

Note: 5" (127mm) swivel casters, two with brakes, are standard on units listed above. Rack packaged in one box and UPS shippable.



End Load Cart



Divider Totes — 16.65

The Metro Tote Box Line offers safe and efficient storage of items in bulk, or in compartmentalized fashion with the use of optional dividers and covers.

- Can be stored and transported on a variety of standard Metro Products (e.g. Metro Kitting Carts found on page 148).

- Manufactured from polypropylene base resins.
- Available in natural gray (NAT), Benstat™ blue static dissipate (BAS), or Bentrion™ black conductive (CAS) compounds.
- Injection molded for longer life and more uniform wall thickness.
- For Dip Tube storage applications, use TB95050 series totes.

Totes (sold in carton quantities as shown)

Cu. Cap (Cu. Ft.)	Inside Dimensions						Outside Dimensions						Weight (lb.) (kg)	Carton Qty.*	Est. Carton Wt. (lbs.)	Cat. No. Natural Polypropylene	Cat. No. Benstat	Cat. No. Bentrion	
	Length (in.) (mm)	Width (in.) (mm)	Stack Depth (in.) (mm)	Length (in.) (mm)	Width (in.) (mm)	Height (in.) (mm)	Length (in.) (mm)	Width (in.) (mm)	Height (in.) (mm)										
.10	9 <sup>3</sup> / <sub>16</sub>	233	6 <sup>9</sup> / <sub>16</sub>	167	3	176	10 <sup>7</sup> / <sub>8</sub>	276	8 <sup>1</sup> / <sub>4</sub>	210	3 <sup>1</sup> / <sub>2</sub>	89	37	16.8	48	37	TB91035NAT	TB91035BAS	TB91035CAS
.19	9 <sup>3</sup> / <sub>16</sub>	233	6 <sup>9</sup> / <sub>16</sub>	167	5 <sup>1</sup> / <sub>2</sub>	138	10 <sup>7</sup> / <sub>8</sub>	276	8 <sup>1</sup> / <sub>4</sub>	210	6	152	34	15.4	24	34	TB91060NAT	TB91060BAS	TB91060CAS
.24	14 <sup>7</sup> / <sub>8</sub>	378	9 <sup>1</sup> / <sub>4</sub>	235	3	76	16 <sup>1</sup> / <sub>2</sub>	419	10 <sup>7</sup> / <sub>8</sub>	276	3 <sup>1</sup> / <sub>2</sub>	89	36	16.3	24	36	TB92035NAT	TB92035BAS	TB92035CAS
.59	15	381	15	381	4 <sup>1</sup> / <sub>2</sub>	114	16 <sup>1</sup> / <sub>2</sub>	419	16 <sup>1</sup> / <sub>2</sub>	419	5	127	35	15.9	12	30	TB92050NAT	TB92050BAS	TB92050CAS
.44	14 <sup>7</sup> / <sub>8</sub>	378	9 <sup>1</sup> / <sub>4</sub>	235	5 <sup>1</sup> / <sub>2</sub>	138	16 <sup>1</sup> / <sub>2</sub>	419	10 <sup>7</sup> / <sub>8</sub>	276	6	152	28	12.7	12	28	TB92060NAT	TB92060BAS	TB92060CAS
.60	14 <sup>7</sup> / <sub>8</sub>	378	9 <sup>1</sup> / <sub>4</sub>	235	7 <sup>1</sup> / <sub>2</sub>	190	16 <sup>1</sup> / <sub>2</sub>	419	10 <sup>7</sup> / <sub>8</sub>	276	8	203	25	11.3	6	19	TB92080NAT	TB92080BAS	TB92080CAS
.44	20 <sup>5</sup> / <sub>8</sub>	524	15 <sup>5</sup> / <sub>8</sub>	397	2 <sup>1</sup> / <sub>2</sub>	63	22 <sup>1</sup> / <sub>2</sub>	571	17 <sup>1</sup> / <sub>2</sub>	445	3	76	36	16.3	12	31	TB93030NAT	TB93030BAS	TB93030CAS
.79	20 <sup>5</sup> / <sub>8</sub>	524	15 <sup>5</sup> / <sub>8</sub>	397	4 <sup>1</sup> / <sub>2</sub>	114	22 <sup>1</sup> / <sub>2</sub>	571	17 <sup>1</sup> / <sub>2</sub>	445	5	127	32	14.5	6	24	TB93050NAT	TB93050BAS	TB93050CAS
.97	20 <sup>5</sup> / <sub>8</sub>	524	15 <sup>5</sup> / <sub>8</sub>	397	5 <sup>1</sup> / <sub>2</sub>	138	22 <sup>1</sup> / <sub>2</sub>	571	17 <sup>1</sup> / <sub>2</sub>	445	6	152	24	10.9	6	24	TB93060NAT	TB93060BAS	TB93060CAS
1.32	20 <sup>5</sup> / <sub>8</sub>	524	15 <sup>5</sup> / <sub>8</sub>	397	7 <sup>1</sup> / <sub>2</sub>	190	22 <sup>1</sup> / <sub>2</sub>	571	17 <sup>1</sup> / <sub>2</sub>	445	8	203	21	9.5	4	21	TB93080NAT	TB93080BAS	TB93080CAS
2.03	20 <sup>5</sup> / <sub>8</sub>	524	15 <sup>5</sup> / <sub>8</sub>	397	11 <sup>1</sup> / <sub>2</sub>	292	22 <sup>1</sup> / <sub>2</sub>	571	17 <sup>1</sup> / <sub>2</sub>	445	12	305	20	9	3	20	TB93120NAT	TB93120BAS	TB93120CAS
.26	24 <sup>3</sup> / <sub>8</sub>	632	4 <sup>3</sup> / <sub>4</sub>	121	4 <sup>1</sup> / <sub>2</sub>	114	26 <sup>1</sup> / <sub>4</sub>	667	6 <sup>1</sup> / <sub>4</sub>	159	5	127	47	21.3	24	49	TB95050NAT	TB95050BAS	TB95050CAS

\*Items must be purchased in carton quantities to avoid a broken lot charge. Pricing based on quantity ordered. Please consult your Metro representative.

Covers\*\*

Type	Carton Qty.*	Est. Carton Wt. (lbs.)	Fits Totes Series	Cat. No. Clear PETG	Cat. No. Natural Polypropylene	Cat. No. Benstat	Cat. No. Bentrion	Fits Totes Series	Cat. No. Clear PETG	Cat. No. Natural Polypropylene	Cat. No. Benstat	Cat. No. Bentrion
Snap-on	96	48	TB91000	—	CO91000NAT	CO91000BAS	CO91000CAS	TB93000	—	CO93000NAT	CO93000BAS	CO93000CAS
Insert	96	30	TB91000	CI91000CLR	CI91000NAT	CI91000BAS	CI91000CAS	TB93000	CI93000CLR	CI93000NAT	CI93000BAS	CI93000CAS
Snap-on	48	23	TB92000	—	CO92000NAT	CO92000BAS	CO92000CAS					
Insert	48	34	TB92000	CI92000CLR	CI92000NAT	CI92000BAS	CI92000CAS	TB95050	—	CI95050NAT	CI95050BAS	CI95050CAS
Snap-on	24	18	TB92050	—	CO92050NAT	CO92050BAS	CO92050CAS					
Insert	24	18	TB92050	—	CI92050NAT	CI92050BAS	CI92050CAS					

\*Items must be purchased in carton quantities to avoid a broken lot charge. Pricing based on quantity ordered. Please consult your Metro representative. Note: If totes are to be used with Kitting Carts on page 148, the insert cover must be used. \*\*When boxes with covers are lip loaded, box weight capacity must not exceed 25 lbs. (11.3kg).

Dividers

Fits Totes	Type	Height (in.) (mm)	Carton Qty.*	Est. Carton Wt. (lbs.)	Cat. No. Natural Polypropylene	Cat. No. Benstat	Cat. No. Bentrion	Type	Est. Carton Qty.*	Carton Wt. (lbs.)	Cat. No. Natural Polypropylene	Cat. No. Benstat	Cat. No. Bentrion	
TB91035	Long	3	76	96	12	DL91035NAT	DL91035BAS	DL91035CAS	Short	96	9	DS91035NAT	DS91035BAS	DS91035CAS
TB91060	Long	5 <sup>1</sup> / <sub>2</sub>	140	96	24	DL91060NAT	DL91060BAS	DL91060CAS	Short	96	17	DS91060NAT	DS91060BAS	DS91060CAS
TB92035	Long	3	76	96	21	DL92035NAT	DL92035BAS	DL92035CAS	Short	96	13	DS92035NAT	DS92035BAS	DS92035CAS
TB92060	Long	5 <sup>1</sup> / <sub>2</sub>	140	96	39	DL92060NAT	DL92060BAS	DL92060CAS	Short	96	33	DS92060NAT	DS92060BAS	DS92060CAS
TB92080	Long	7 <sup>1</sup> / <sub>2</sub>	191	96	54	DL92080NAT	DL92080BAS	DL92080CAS	Short	96	24	DS92080NAT	DS92080BAS	DS92080CAS
TB93030	Long	2 <sup>1</sup> / <sub>2</sub>	64	96	25	DL93030NAT	DL93030BAS	DL93030CAS	Short	96	34	DS93030NAT	DS93030BAS	DS93030CAS
TB93050	Long	4 <sup>1</sup> / <sub>2</sub>	114	96	44	DL93050NAT	DL93050BAS	DL93050CAS	Short	96	18	DS93050NAT	DS93050BAS	DS93050CAS
TB93060	Long	5 <sup>1</sup> / <sub>2</sub>	140	96	53	DL93060NAT	DL93060BAS	DL93060CAS	Short	96	32	DS93060NAT	DS93060BAS	DS93060CAS
TB93080	Long	7 <sup>1</sup> / <sub>2</sub>	191	96	72	DL93080NAT	DL93080BAS	DL93080CAS	Short	96	40	DS93080NAT	DS93080BAS	DS93080CAS
TB92050		4 <sup>1</sup> / <sub>2</sub>	114					Long/Short	96	55	DS92050NAT	DS92050BAS	DS92050CAS	
TB95050		4 <sup>1</sup> / <sub>2</sub>	114					Short	96	55	DS95050NAT	DS95050BAS	DS95050CAS	

\*Items must be purchased in carton quantities to avoid a broken lot charge. Pricing based on quantity ordered. Please consult your Metro representative.



Tote Box with Snap-on Cover



Tote Box with Dividers

**Card Holders — 16.65**

Includes snaps to fit all Metro totes. ESD Benstat also available.

Material	Holds Card Size		Carton Qty.*	Est. Carton Wt. (lbs.)	Cat. No.
	(in.)	(mm)			
Benstat	5x8	127x203	96	10	OP2501BAS
Benstat	3x5	76x129	96	10	OP2535BAS
Polypropylene	5x8	127x203	96	10	OP2501CLR
Polypropylene	3x5	76x129	96	10	OP2535CLR

\*Items must be purchased in carton quantities to avoid a broken lot charge.  
Pricing based on quantity ordered. Please consult your Metro representative.



Tote Boxes (shown with Cardholder)

**Stacking Bins — 16.65**

Metro stacking bins are injection molded from polypropylene base resins in natural gray (NAT), static dissipative blue Benstat (BAS), or black conductive Bentron (CAS) compounds. All sizes have an open hopper front for easy access to contents and a slot on the back for use on bin holder bars.

Length (in.)	Length (mm)	Width		Height		Carton Qty.*	Est. Carton Wt. (lbs.)	Cat. No.	Cat. No.	Cat. No.
		(in.)	(mm)	(in.)	(mm)			Natural Polypropylene	Benstat	Bentron
7 <sup>3</sup> / <sub>8</sub>	187	4 <sup>1</sup> / <sub>8</sub>	105	3	76	48	36	SB90743NAT	SB90743BAS	SB90743CAS
10 <sup>7</sup> / <sub>8</sub>	276	5 <sup>1</sup> / <sub>2</sub>	140	5	127	24	25	SB91055NAT	SB91055BAS	SB91055CAS
14 <sup>3</sup> / <sub>4</sub>	375	8 <sup>3</sup> / <sub>4</sub>	210	7	179	12	18	SB91587NAT	SB91587BAS	SB91587CAS
14 <sup>3</sup> / <sub>4</sub>	375	16 <sup>1</sup> / <sub>2</sub>	419	7	179	6	18	SB91516NAT	SB91516BAS	SB91516CAS
8	203	3 <sup>1</sup> / <sub>2</sub>	89	4 <sup>1</sup> / <sub>8</sub>	105	48	39	SB90835NAT	SB90835BAS	SB90835CAS

\*Items must be purchased in carton quantities to avoid a broken lot charge.  
Pricing based on quantity ordered. Please consult your Metro representative.



Stacking Bins

**Dividers for Bins**

Type	Fits	Carton Qty.*	Est. Carton Wt. (lbs.)	Cat. No. Natural Polypropylene	Cat. No. Benstat	Cat. No. Bentron
Long	SB91516	6	3	DL91516NAT	DL91516BAS	DL91516CAS
Long	SB90835	48	24	DI90835NAT	DI90835BAS	DI90835CAS

\*Items must be purchased in carton quantities to avoid a broken lot charge.  
Pricing based on quantity ordered. Please consult your Metro representative.

# Good Clean Design

**Class Act.**  
 “Independent Testing confirms Metro’s Super Erecta® wire shelving/carts, solid louvered shelving/carts and Clean Tables (Perf) are appropriate for use in FED. Std. 209E Class 1 (ISO14644: ISO 3) environments.”  
 Test results available upon request.



MW700 Series shown

## Cleanroom Carts

- A durable, dependable transport solution that’s easy to maneuver.
- Highly rigid Super Erecta® construction lets you easily adjust shelves at 1" (25mm) increments.
- Each cart consists of 2 handles, indicated number of shelves of material listed, and casters. 18" (457mm) wide carts have 4" (102mm) light-duty casters and are 38" (965mm) high. 21" (530mm) and 24" (610mm) wide carts have 5" (127mm) light-duty casters providing 375 lbs. (171kg) of load capacity and are 39" (990mm) high.
- Shipped knocked-down.

For more information, see page 84. For heavier-duty carts, see SP Series Carts on page 85.



## Super Erecta® Stainless Open-Wire Shelving

- The original wire storage and handling system has become the standard in the cleanroom industry.
- Manufactured from electro-polished, Type 304 stainless steel.
- Super Erecta® open-wire design facilitates maximum laminar airflow.

Refer to pages 37-62 for more information.



## Super Erecta Shelf® All-Stainless Solid Shelving

- Solid shelving is available in four widths and six lengths.
- All-stainless, 18-gauge steel construction with 1/8" (3mm) ship’s edge detail helps contain spills.
- All-stainless design, including stainless cast corners, can be used in cart wash and autoclave environments. Refer to autoclave guidelines on page 183.
- New accessories include high-temperature autoclave casters and autoclave cart covers.



All stainless solid shelf with stainless corners

Refer to pages 181-183 for more information.

## Class Act.

"Independent Testing confirms Metro's Super Erecta® wire shelving/carts, solid louvered shelving/carts and Clean Tables (Perf) are appropriate for use in FED. Std. 209E Class 1 (ISO14644: ISO 3) environments." Test results available upon request.



Perf Top Table

## Perf Top Clean Tables — 58.01

Type 304 stainless steel, HD Super™ posts and proven Super Erecta construction throughout.

- Units are shipped knocked down to minimize freight charges and handling and can be assembled in minutes.
- All perf top tables feature height adjustable legs (33" to 40" [838 to 1016mm] in 1" [25mm] increments).
- All tables with overheads have 74" (1880mm) high rear posts.
- Cantilever shelves are sold separately, see below.
- Customize with available accessories.

ESD Classification: Non-Conductive (Units can be made conductive with the addition of H.D. aluminum split sleeves and a cleanroom grounding cable (found on page 149).

### Perf Top

Top manufactured from 14 gauge, Type 304 electro-polished stainless steel, with .75" (19mm) holes on 1" (25mm) centers. Support members have satin finish. Table provides approximately 35% open area.

Width/Length (mm)		Perf Top		Perf Top with Overhead	
(in.)	(mm)	Approx. Pkd. Wt. (lbs.)	(kg)	Approx. Pkd. Wt. (lbs.)	(kg)
30x36	762x914	35	15.9	42½	19.3
30x48	762x1219	46	20.9	53½	24.3
30x60	762x1524	58	26.3	65½	29.7
30x72	762x1825	69	31.3	76½	34.7

### Cantilever Shelves for Overhead

All heavy-duty Cantilever shelves are 12" (317mm) wide. Electro-polished, Type 304 stainless steel.

Length (in.)	(mm)	Fits Units (in.)	(mm)	Approx. Pkd. Wt. (lbs.)	(kg)	Cat. No.
36	914	36	914	6½	2.9	1236CHS
48	1219	48	1219	10½	4.8	1248CHS
60	1524	60	1524	13	6	1260CHS
72	1825	72	1825	15½	7	1272CHS

Note: Cannot be used with accessory grid panels.

## Perf Top Accessory Grid Panels — 58.01

Includes attachment hardware.

Description	Width/Length (in.)		Fits Table Length (in.)		Approx. Pkd. Wt. (lbs.)		(kg)	Cat. No.
Grid Panel (A)	33x36	838x914	36	914	13½	6.3	WGR3336S	
Grid Panel (A)	33x48	838x1219	48	1219	18½	8.3	WGR3348S	
Grid Panel (A)	33x60	838x1524	36	1524	23	10.4	WGR3360S	
Grid Panel (A)	33x72	838x1829	72	1829	27½	12.5	WGR3372S	

Note 1: For use with Perf Top Tables.

Note 2: Grid panels and accessories cannot be used with overhead cantilever shelves.

### Accessories

Manufactured from Type 304 stainless steel.

Description	(in.)	Width/Length (mm)	Approx. Pkd. Wt. (lbs.)	(kg)	Cat. No.
Monitor Shelf (B)	16¾x16¾	425x425	6	2.7	PBA-MSS
Utility Shelf (C)	9x18½	228x470	4	1.8	PBA-GSDS
Utility Basket (D)	5x13¾x7	127x345x180	8½	4	H209S

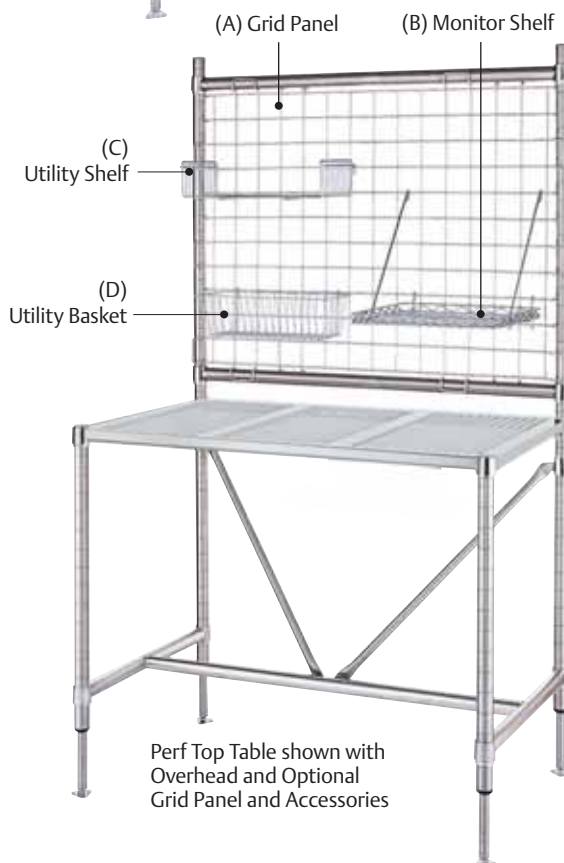

Perf Top Table shown with Overhead and Optional Grid Panel and Accessories



Cantilever Shelves

For solid top stainless steel worktables see pages 192-194.



MW100 Series

MW Carts — **12.01** **12.05**

The most efficient way to create mobile space.

- Ergonomically-designed for low-effort transport.
- Precise handling you need to maneuver in close quarters.
- Sturdy aluminum corner castings firmly secure solid shelves to posts.

MW Two-Shelf Models

MW100 Series — 2 Solid Shelves

Width/Length (in.)	Length (mm)	Approx. Pkd. Wt.		Handles and Shelf Material	Cat. No.
		(lbs.)	(kg)		
18x24	457x610	40	18.1	Stainless Steel	<b>MW103</b>
18x30	457x760	45	20.4	Stainless Steel	<b>MW104</b>
18x36	457x914	48	21.8	Stainless Steel	<b>MW105</b>
21x36	530x914	54	24.5	Stainless Steel	<b>MW106</b>
24x36	610x914	60	27.2	Stainless Steel	<b>MW108</b>



MW400 Series

MW400 Series — 1 Solid, 2 Wire Shelves

Width/Length (in.)	Length (mm)	Approx. Pkd. Wt.		Shelf Material	Handles	Cat. No.
		(lbs.)	(kg)			
18x24	457x610	43	19.5	Stainless Steel, Chrome	Chrome	<b>MW401</b>
18x30	457x760	47	21.3	Stainless Steel, Chrome	Chrome	<b>MW402</b>
18x36	457x914	52	23.6	Stainless Steel, Chrome	Chrome	<b>MW403</b>
21x36	530x914	59	26.8	Stainless Steel, Chrome	Chrome	<b>MW404</b>
24x36	610x914	65	29.5	Stainless Steel, Chrome	Chrome	<b>MW406</b>



MW600 Series

MW600 Series — 2 Wire Shelves

Width/Length (in.)	Length (mm)	Approx. Pkd. Wt.		Shelf Material	Handles	Cat. No.
		(lbs.)	(kg)			
18x24	457x610	34	15.4	Chrome	Chrome	<b>MW601</b>
18x24	457x610	34	15.4	Stainless Steel	Stainless Steel	<b>MW602</b>
18x30	457x760	37	16.8	Chrome	Chrome	<b>MW603</b>
18x30	457x760	37	16.8	Stainless Steel	Stainless Steel	<b>MW604</b>
18x36	457x914	40	18.1	Chrome	Chrome	<b>MW605</b>
18x36	457x914	39	17.7	Stainless Steel	Stainless Steel	<b>MW606</b>
21x36	530x914	44	20.0	Chrome	Chrome	<b>MW607</b>
21x36	530x914	44	20.0	Stainless Steel	Stainless Steel	<b>MW608</b>
24x36	610x914	47	21.3	Chrome	Chrome	<b>MW611</b>
24x36	610x914	46	20.9	Stainless Steel	Stainless Steel	<b>MW612</b>

**Note:** 18" (457mm) wide carts have 4" (102mm) light-duty casters. 21" (533mm) and 24" (610mm) wide carts have 5" (127mm) light-duty casters.



**Chemical Transport — 58.10**

A safe method for transporting chemicals.

- Cart is manufactured from Type 304 stainless steel with a chemical resistant polyethylene drip tray.
- 7<sup>5</sup>/<sub>32</sub>"x7<sup>5</sup>/<sub>32</sub>" (184x184mm) openings provide capacity for eight 4-liter-sized containers.
- Two swivel and two brake casters included.\*

ESD Classification: Non-Conductive. (Units can be made conductive with the addition of conductive plastic split sleeves and a grounding cable.)

Width/Length (in.) (mm)		Approx. Pkd. Wt. (lbs.) (kg)		Cat. No.
21x30	533x762	37	16.8	<b>CT2130S</b>

\*Casters not recommended for over-the-road applications, or wet and humid environments.



CT2130S

**Sanitation Cart**

Designed for trash removal from controlled environments.

ESD Classification: Non-Conductive. (Units can be made conductive with the addition of conductive plastic split sleeves and a grounding cable.)

As shown, chrome, size 24"x48" (610x1219mm)

- (2) SF55N3C — Page 55
- (4) 33UP — Page 42
- (2) 2448NC — Page 42
- (2) 5MP — Page 48
- (2) 5MPB — Page 48



Sanitation Cart

**Cleanroom Casters — 58.10**

Designed to provide vibration dampening in controlled environments. Nickel horn, resilient tread wheel, dust cover, and Celcon bearing. Offers superior rollability and maneuverability and resists virtually all common cleaners, solvents, oils and acids.

Wheel Diameter (in.) (mm)	Face (in.) (mm)	Load Rating (kg) (lbs.)	Type	Wheel Tread	Approx. Pkd. Wt. (lbs.) (kg)	Cat. No.
5 127	1 <sup>1</sup> / <sub>4</sub> 32	300 135	Stem/Swivel	High Modulus	2 <sup>1</sup> / <sub>2</sub> 1.1	<b>5MFA</b>
5 127	1 <sup>1</sup> / <sub>4</sub> 32	300 135	Stem/Swivel	High Modulus	2 <sup>1</sup> / <sub>2</sub> 1.1	<b>5MFBA</b>

**Note:** Toe-operated brake.

**Note:** Not recommended for wet or humid environments.



5MFA



Upright Garment Rack



Wall Mount Garment Rack



Economy Garment Rack



Garment Storage Rack

**Garment Rack — Upright and Wall Mount — 58.15**

Racks are designed to provide efficient storage of Cleanroom garments. Hangers are spaced at 3" (75mm) intervals. Electro-polished, Type 304 stainless steel hangers are included.

- Type 304 stainless steel construction throughout.
- Open-wire design promotes laminar air flow.
- Adjustable stainless steel leveling feet provide floor mount or free standing option.
- Unique hanger capture mechanism and hanger design provide theft deterrence.

ESD Classification: Non-Conductive (Units can be made conductive with use of conductive plastic split sleeves, page 149.)

**Upright**

Width/Length (in.) (mm)		No. of Hangers	Approx. Pkd. Wt. (lbs.) (kg)		Cat. No.
24x36	610x914	11	27	12.25	GRU2436S
24x48	610x1219	15	36	16.25	GRU2448S
24x60	610x1524	19	45	20.5	GRU2460S
24x72	610x1825	23	54	24.5	GRU2472S

**Wall Mount**

Width/Length (in.) (mm)		No. of Hangers	Approx. Pkd. Wt. (lbs.) (kg)		Cat. No.
24x36	610x914	11	20	9	GRW2436S
24x48	610x1219	15	22½	10.2	GRW2448S
24x60	610x1524	19	27½	12.5	GRW2460S
24x72	610x1825	23	32	14.5	GRW2472S

**Economy Garment Rack — 58.15**

Metro Super Erecta shelving can be customized for many specific storage and handling tasks. The following standard components may be combined to create an economical Garment Rack, as shown, in chrome.

ESD Classification: Non-Conductive (Units can be made conductive with the addition of conductive plastic split sleeves.)

- 4 – 74P ..... Posts — Page 42
- 2 – 2448NC ..... Shelves — Page 42
- 4 – 9993Z ..... Footplates — Page 44
- 1 – SF55N3C ..... Frame — Page 55
- 1 – AT4824NC ..... Garment Tube — Page 56
- 15 – CC5923A ..... Hangers: Closed Top Loop Chrome finish

**Garment Storage Rack — 58.15**

Metro Super Erecta shelving can be customized for many specific storage and handling tasks. To store packaged garments the following standard components may be combined to create a storage rack, as shown. Stainless steel.

- Available in electro-polished, Type 304 stainless steel or chrome
- Many sizes available to meet your exact requirements

ESD Classification: Non-Conductive (Units can be made conductive with the addition of conductive plastic split sleeves.)

- 4 – 63UPS ..... Posts — Page 42
- 5 – 2448NS ..... Shelves — Page 42
- 15 – DD24S ..... Dividers — Page 53
- 5 – L48N-4S ..... Back Ledges — Page 53
- 10 – L24N-4S ..... Side Ledges — Page 53
- 2 – 5MF ..... Stem Casters — Page 161
- 2 – 5MFBA ..... Stem Casters with Brakes — Page 161

**Metro Tip:**  
For Cleanroom Stainless Steel shelving, please refer to pages 37, 42 and 65.

**Gowning Bench — 58.15**

Heavy-duty, solid top bench provides a sturdy and comfortable gowning fixture.

- Top is manufactured from 14 gauge, Type 304 stainless steel.
- Stainless steel footplates provide floor mount or free-standing option.

ESD Classification: Non-Conductive (Units can be made conductive with the addition of H.D. aluminum split sleeves.)

Width/Length (in./mm)		Approx. Pkd. Wt. (lbs./kg)		Cat. No.
16x36	406x914	47½	21.5	<b>GB1636S</b>
16x48	406x1219	55	25	<b>GB1648S</b>
16x60	406x1524	62½	28.4	<b>GB1660S</b>
16x72	406x1825	70	31.8	<b>GB1672S</b>



Gowning Bench

**Bootie/Shoe Rack — 58.15**

Metro Super Erecta shelving can be customized for many specific storage and handling tasks. To store cleanroom booties or shoes the following standard components may be combined to create a storage rack as shown. Stainless steel.

- Available in electro-polished, Type 304 stainless steel or chrome
- Open-wire design maintains laminar air flow
- High-density storage
- Optional snap-on label holders

ESD Classification: Non-Conductive (Units can be made conductive with the addition of conductive plastic split sleeves.)

As shown, stainless steel

- 4 — 63PS ..... Posts — Page 42
- 5 — 2448NS ..... Shelves — Page 42
- 12 — R52S ..... Rods/Tabs — Page 55



Bootie/Shoe Rack



# LABORATORY PRODUCTS

Lab Carts & Storage.....	166-180
Autoclave Storage & Carts.....	181-183
LAR Feed Carts & Storage.....	184-185
Lab Worktables & Accessories.....	186-194
Mobile Computing WorkCenters.....	195
Portable Power Module/Units.....	196-197
Starsys Lab Furniture.....	198-227



**Microban**  
2-Shelf BC Series Cart

### Polymer Utility Carts

Shelves are fabricated of tough, chemical-resistant, high-density polyethylene, an extremely resilient polyolefin that provides excellent chemical resistance across a wide range of substances (including most acids and bases).

### BC and Deep Ledge Utility Carts with Microban®

Shelves have built-in Microban® antimicrobial product protection that inhibits the growth of bacteria, mold, and mildew.

- Easy to Clean: Smooth, injection-molded polymer shelves wipe clean easily. Aesthetic light blue color.

Cart Description	Width/Length/Height		Approx. Pkd. Wt.		Cat. No.
	(in.)	(mm)	(lbs.)	(kg)	
2-Shelf Deep Ledge	21 1/2x32 3/4x41	546x832x1041	29	13.1	<b>BC2030-2DMB</b>
3-Shelf Deep Ledge	21 1/2x32 3/4x41	546x832x1041	37 1/2	17.0	<b>BC2030-3DMB</b>
2-Shelf BC Series	18x28x33 1/4	457x711x845	27 1/2	12.4	<b>BC1627-24MB</b>
3-Shelf BC Series	18x28x33 1/4	457x711x845	33	14.9	<b>BC1627-34MB</b>
2-Shelf BC Series	21 1/2x33 3/4x33 1/4	546x857x845	34 1/2	15.6	<b>BC2030-24MB</b>
3-Shelf BC Series	21 1/2x33 3/4x33 1/4	546x857x845	43	19.5	<b>BC2030-34MB</b>



2-Shelf Deep Ledge Utility Cart

### Deep Ledge Utility Carts

- Polymer shelves are easy to clean and corrosion proof.
- Shelves provide a 2 3/4" (70mm) deep ledge to contain products and spills.
- 2-shelf and 3-shelf models, available in three colors including: Gray, Blue, and Black.

(in.)	Width/Length/Height		Description	Approx. Pkd. Wt.		Cat. No.
	(mm)	(mm)		(lbs.)	(kg)	
21 1/2x32 3/4x41	546.1	831.9	2-shelf unit	29	13.1	<b>BC2030-2D</b>
21 1/2x32 3/4x41	546.1	831.9	3-shelf unit	37 1/2	17.0	<b>BC2030-3D</b>
27x38 3/4x41	685.8	984.3	2-shelf unit	35	15.9	<b>BC2636-2D</b>
27x38 3/4x41	685.8	984.3	3-shelf unit	46 1/2	21.1	<b>BC2636-3D</b>

Cart is available in 2-shelf and 3-shelf models.

\*Colors available are: Gray (G), Blue (BU), and Black (BL). Add color designation to part number when ordering, i.e.: BC2030-3DG = Three-shelf Gray unit.



**Microban**  
3-Shelf Deep Ledge Utility Cart



Gray (G)



Blue (BU)



Light Blue (Microban)



Black (BL)

Indicates antimicrobial product.

\*MICROBAN® and the MICROBAN® symbol are registered trademarks of the Microban Products Company, Huntersville, NC.

### MetroMax i® Lab Storage Cart

- **Corrosion Proof** — A unique storage and transport system: Engineered polymers and Type 304 stainless are warranted against rust and corrosion for the life of the product.
- **Microban®\* antimicrobial product protection** — A Metro exclusive — is built into all shelves and touch points, inhibiting the growth of mold, mildew, and bacteria.
- **Cleanable** — Lift off grid and solid shelf mats are sized to fit into a sink making cleaning easy.
- **Flexible** — A range of shelf sizes, post heights and accessories allow you to “customize” the system to fit your requirements.

See pages 14-28.



### MetroMax i® Utility Carts

- Removable shelves provide easy cleaning.
- Open-architecture design allows for our full line of accessories to be used.
- 2-shelf and 3-shelf configurations available.
- Weight capacity 600 lbs. (272kg) per cart.

Width/Length/Height (in.) (mm)		Description	Cat. No.
18x30x40	457x760x1015	2-shelf	<b>MXUC1830GX2-25</b>
24x36x40	610x914x1015	2-shelf	<b>MXUC2436GX2-25</b>
18x30x40	457x760x1015	3-shelf	<b>MXUC1830GX2-35</b>
24x36x40	610x914x1015	3-shelf	<b>MXUC2436GX2-35</b>



MetroMax i Utility Cart

For Stainless Steel Wire and Solid Carts, see pages 84-85.

### MetroMax i® Lab Carts — 52.01

Metro’s Lab Cart line includes a General Lab Cart, Chemical Cart, and Mobile Desk. All carts are designed to offer superior corrosion resistance. Smooth rolling, 5" (127mm) polyurethane casters come standard with each cart. All shelves adjust in 1/2" (12.7mm) increments, offering precise shelf adjustment and maximum storage utilization.



MDSX3  
Mobile Desk  
(casters included)  
Monitor Mounting Bar, Mounting Bracket, and Keyboard Shelf sold separately. (See page 168)



LABX3  
General Lab Cart  
(casters included)



CHEMX3  
Chemical Cart  
(casters included)

Width (in.) (mm)	Length (in.) (mm)	Height (in.) (mm)	Cart Load Rating (lbs.) (kg)	Description	Approx. Pkd. Wt. (lbs.) (kg)	Cat. No.
18 457	36 914	40 1016	600 273	General Lab Cart	43 19.5	<b>LABX3</b>
18 457	36 914	40 1016	600 273	Chemical Cart	49 22.2	<b>CHEMX3</b>
18 457	36 914	40 1016	600 273	Mobile Desk	55 24.9	<b>MDSX3<sup>1</sup></b>

<sup>1</sup> Mobile desk features a phenolic work surface offering a high level of corrosion resistance. Mobile desk includes: four polyurethane brake casters, each measuring 5" (127mm), for maximum stability when foot-operated brakes are engaged.  
**Note:** All carts include 5MPX series casters (2 brake, 2 swivel), unless otherwise noted.

Indicates antimicrobial product.

\*MICROBAN® and the MICROBAN® symbol are registered trademarks of the Microban Products Company, Huntersville, NC.



FMAX and TMX



HPLC3X3  
(Shown with accessories and casters)

### MetroMax i® High-Performance Liquid Chromatography (HPLC) Carts — 52.01

- HPLC carts contribute to greater benchtop productivity.
- Mobilize and stack HPLC equipment on carts to maximize valuable lab space.
- Avoid crowding valuable bench top space with High-Performance Liquid Chromatography (HPLC) or other analytical equipment.

#### HPLC Models — 4 Shelf Models (Casters not included\*)

Width (in.) (mm)	Length (in.) (mm)	Height (in.) (mm)	Description	Approx. Pkd. Wt. (lbs.) (kg)	Cat. No.
24 610	30 760	81 2288	4-Shelf Unit Single Experiment Cart	70 32	<b>HPLC3X3</b>
24 610	48 1219	81 2288	4-Shelf Unit Double Experiment Cart	101 46	<b>HPLC4X3</b>

See page 190 for Caster Selection Guide.

#### HPLC Models — 5 Shelf Models (Casters included)

Width (in.) (mm)	Length (in.) (mm)	Height (in.) (mm)	Description	Approx. Pkd. Wt. (lbs.) (kg)	Cat. No.
24 610	30 760	81 2288	5-Shelf Unit Single Experiment Cart	89.5 40.6	<b>HPLC1X3</b>
24 610	48 1219	81 2288	5-Shelf Unit Double Experiment Cart	114.5 51.9	<b>HPLC2X3</b>

**Note 1:** Single HPLC experiment carts feature a 24"x30" (610x760mm), five-shelf unit (4 solid, 1 open-grid shelf), mounted on 74" (1880mm) mobile posts. Double HPLC experiment carts feature a 24"x48" (610x1219mm), five-shelf unit (4 solid, 1 open-grid shelf) mounted on a 74" (1880mm) mobile posts.

**Note 2:** Metro tote boxes can be used to complete the system, either on the bottom shelf to contain test beakers or flasks, or in conjunction with an Undershelf Slide (see page 26) to provide a drawer for small tool storage.

#### Accessories

Description	Approx. Pkd. Wt. (lbs.) (kg)	Cat. No.
Post-Mount Swing Arm for Flat Monitor	4.5 2.0	<b>FMAX</b>
Post-Mount Cable/Tube Management Clips	1.0 .45	<b>TMX</b>



KBX

#### Slide-out Keyboard Shelf

Epoxy-coated keyboard shelf provides high level of corrosion resistance. Designed to fit both 18" (457mm) and 24" (610mm) wide MetroMax i shelves. Keyboard shelf loading should not exceed 10 lbs. (45.8kg).

Dimensions: 16"W.x26<sup>1</sup>/<sub>2</sub>"L.x5"H. (406x673x127mm)

Cat. No. **KBX**

#### Flat Monitor Mounting Kit

Unique mounting bracket and cross-bar design permits flat monitor to be mounted on MetroMax i units. Flat monitor can be mounted between two MetroMax i posts, either in back or front of unit. Mounting bracket loading should not exceed 30 lbs. (14kg). VESA mounting plates included with bracket.

Note: For flat monitor mounting on MetroMax i order either Cat. No. FM30X3, FM36X3, or FM48X3 (Cross-bar and mounting bracket included). For flat monitor mounting on Mobile Desk order Cat. No. FMBX.

Cross-Bar Dimensions:

2<sup>1</sup>/<sub>8</sub>"W.x30"L.x3"H. (54x762x76mm)

2<sup>1</sup>/<sub>8</sub>"W.x36"L.x3"H. (54x914x76mm)

2<sup>1</sup>/<sub>8</sub>"W.x48"L.x3"H. (54x1219x76mm)

Cat. No. **FM30X3** (Bracket and Cross Bar)

Cat. No. **FM36X3** (Bracket and Cross Bar)

Cat. No. **FM48X3** (Bracket and Cross Bar)

Cat. No. **FMBX** (Mounting Bracket only)

Bracket Dimensions:

3<sup>7</sup>/<sub>16</sub>"W.x8<sup>13</sup>/<sub>16</sub>"L.x5<sup>3</sup>/<sub>4</sub>"H. (87x223x146mm) (Cat. No. FMBX)

#### Power Strip

Six outlet power strip, featuring surge protection, mounts flush with any MetroMax i shelf frame. Power strip is UL approved. Gray power strip comes with 6 foot (1829mm) long cord.

Dimensions: 2<sup>1</sup>/<sub>4</sub>"W.x13"L.x4<sup>1</sup>/<sub>4</sub>"H. (57x330x108mm)

Cat. No. **PSX**



FM30X3/FM36X3/FM48X3  
(Cross Bar and Mounting Bracket included)

#### Usage Instruction

- When flat monitor mounting kit is in use, please remove flat monitor from cross bar before cart transport.



PSX

✓ Indicates antimicrobial product.



**MetroMax i® Glassware Carts — 52.01**

- Two-basket and four-basket capacity glassware solutions are offered in a space-saving 18" x 36" (457 x 914mm) footprint.
- Solid MetroMax i bottom shelf provides spill retention and can be removed from shelf frame for easy cleaning.
- MetroMax i components provide lifetime corrosion protection.
- Choose from a wide range of accessories, including all-polymer casters, for maximum corrosion resistance and premium performance.

Refer to page 190 for choice of casters. Units listed below do not include casters. Metro's 5PC series (two brake, two swivel) casters are recommended for superior lifetime performance. **Order casters separately.**

Width		Length		Height		Description	Approx. Pkd. Wt.		Cat. No.
(in.)	(mm)	(in.)	(mm)	(in.)	(mm)		(lbs.)	(kg)	
18	457	36	914	40	1016	2-Basket Unit	38	17	<b>GWBX3-1</b>
18	457	36	914	60	1524	4-Basket Unit	83	37	<b>GWBX3-2</b>
18	457	36	914	40	1016	2-Tote Kit Unit	36	16.3	<b>GWTX3-1</b>
18	457	36	914	60	1524	4-Tote Kit Unit	101	46	<b>GWTX3-2</b>



GWBX3-1  
(Shown with Metro Tote Kit on bottom shelf and casters)

**Accessories**

Width		Length		Height		Description	Approx. Pkd. Wt.		Cat. No.
(in.)	(mm)	(in.)	(mm)	(in.)	(mm)		(lbs.)	(kg)	
18	457	36	914	32	889	Clear Cart Cover — Short Unit	2.5	1.1	<b>GWCV41</b>
18	457	36	914	52	1320	Clear Cart Cover — Tall Unit	3.5	1.6	<b>GWCV62</b>
18	457	36	914	32	889	Blue Cart Cover — Short Unit	2.5	1.1	<b>GWSVC41</b>
18	457	36	914	52	1320	Blue Cart Cover — Tall Unit	3.5	1.6	<b>GWSVC62</b>
Tote Glassware Transport Kit							38.0	17.0	<b>*GWOLYKIT</b>
18	457	35½	901	7	178	Vinyl-Coated Baskets (2)	8.0	3.6	<b>GWBSKT36</b>

\*Each Metro tote kit includes TB93060NAT (1), TB92060NAT (1), DL93060NAT (3), DS93060NAT (3), DS92060NAT (3), and DL92060NAT (3).



GWBX3-1  
(with blue cart cover and casters)



GWBX3-1  
(with clear cart cover and casters)

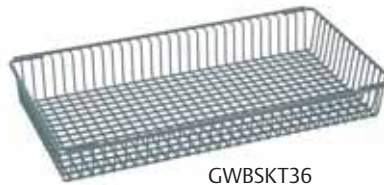

GWBSKT36



GWTX3-1  
(Includes two tote boxes. Casters and additional tote boxes sold separately)



Red shelf markers can be used to designate unclean glassware (See page 59)



Blue shelf markers can be used to designate clean glassware (See page 59)



MetroMax i Glassware Cart

By combining standard MetroMax i components, including MetroMax i baskets, a custom glassware cart can be created. Contact your Metro representative for more information.

Indicates antimicrobial product.

Flexline™

- The time-tested Flexline enclosed polymer cart system has been redesigned to provide unique flexibility and contemporary styling that withstands the rigors of a lab environment.
- Corrosion-proof, smooth, stain-resistant polymer surfaces with rounded corners make cleaning quick and thorough.
- Microban®\* antimicrobial product protection is built in every cart, inhibiting the growth of mold, mildew and bacteria.
- Available in pre-configured carts and build-a-cart components. To configure a cart to your exact specifications, visit [www.metroconfigurator.com](http://www.metroconfigurator.com).

Pre-Configured carts include accessories shown.



LAR Procedure  
Cat. No. **FLISO1**



LAR Procedure – Tall  
Cat. No. **FLISO3**



General Storage  
Cat. No. **FLBED**



LAR Procedure  
Cat. No. **FLTMENT1**



General Storage  
Cat. No. **FLTMENT2**



LAR Procedure with Overhead Package  
Cat. No. **FLCAST**

\*MICROBAN® and the MICROBAN® symbol are registered trademarks of the Microban Products Company, Huntersville, NC.



### Flexline Application-Specific Carts

Carts shown on the previous pages are configured with the components and accessories listed here.

#### Accessories

Cat. No.	Description	FLIS01	FLIS03	FLBED	FLTMENT1	FLTMENT2	FLCAST
FL113	3" (76mm) Drawer Divider Kit		1			2	1
FL116	6/9" (152/229mm) Drawer Divider Kit		3			2	1
FL212	Side Bin (1) — Non Locking	2					4
FL221	Waste Basket 28 Quart & Holder						X
FL237	Glove Box Holder — Triple		X				
FL314	Pull Out Side Shelf		X				X
FL411	Auto Lock Keyless Entry Touch Pad				X		
FL520	Overbridge with 2 Shelves						X

#### Carts

Cat. No.	Description	FL-YL	FL-YL	FL-VL	FL-GR	FL-SB	FL-OR
FL21P	36" (914mm) Cart — Passive Lock	X					
FL30P	45" (1143mm) Cart — Passive Lock						X
FL30K	45" (1143mm) Cart — Key Lock		X				
FLN21K	36" (914mm) Narrow Cart — Key Lock			X	X		
FL-	Drawer Pull Color						

#### Drawers

Cat. No.	Description	FL-YL	FL-YL	FL-VL	FL-GR	FL-SB	FL-OR
FL103	3" (76mm) Drawer		1	2	1	2	3
FL106	6" (152mm) Drawer	2		1	3	2	2
FL109	9" (229mm) Drawer	1	3	1		1	1

Basic Carts with Drawers



FLNK22100

Cart	Drawer Configuration	Lock	Drawer Pull Color	Cat. No.
36" (914mm)H Standard	2 - 3" (76mm) 1 - 6" (152mm) 1 - 9" (229mm)	Key Lock	Violet	<b>FLK21100</b>
36" (914mm)H Narrow	3 - 3" (76mm) 2 - 6" (152mm)	Key Lock	Pink	<b>FLNK3200</b>
39" (991mm)H Standard	3 - 3" (76mm) 1 - 6" (152mm) 1 - 9" (229mm)	Passive Lock	Red	<b>FLP31100</b>
42" (1067mm)H Narrow	2 - 3" (76mm) 2 - 6" (152mm) 1 - 9" (229mm)	Key Lock	Slate Blue	<b>FLNK22100</b>
42" (1067mm)H Standard	4 - 3" (76mm) 1 - 6" (152mm) 1 - 9" (229mm)	Passive Lock	Slate Blue	<b>FLP41100</b>
42" (1067mm)H Narrow	3 - 9" (229mm)	Key Lock	Dark Taupe	<b>FLNK00300</b>
45" (1143mm)H Standard	2 - 3" (76mm) 2 - 6" (152mm) 1 - 12" (305mm)	Passive Lock	Orange	<b>FLP22010</b>
45" (1143mm)H Narrow	1 - 3" (76mm) 3 - 6" (152mm) 1 - 9" (229mm)	Passive Lock	Green	<b>FLNP13100</b>

Build-a-Cart

STANDARD CART

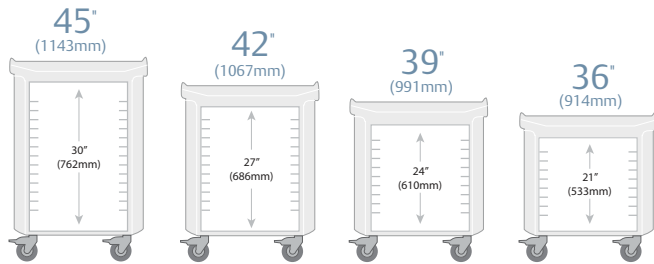

NARROW CART

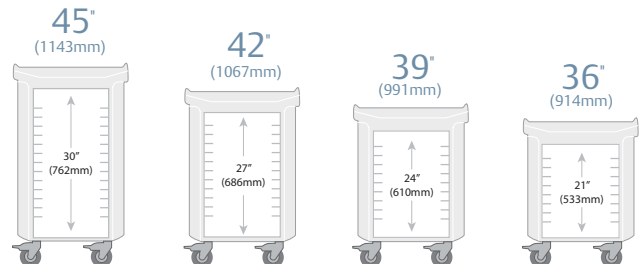

Cart Bodies without Drawers

Width/Length/Height in. (mm)	Drawer Space in. (mm)	Lock	Width	Cat. No.
22 <sup>3</sup> / <sub>8</sub> (568mm) x 32 <sup>1</sup> / <sub>4</sub> (819mm) x 34 <sup>7</sup> / <sub>8</sub> (886mm)	21" (533mm)	Passive Lock	Standard	<b>FL21P</b>
22 <sup>3</sup> / <sub>8</sub> (568mm) x 32 <sup>1</sup> / <sub>4</sub> (819mm) x 38 <sup>7</sup> / <sub>8</sub> (988mm)	24" (610mm)	Passive Lock	Standard	<b>FL24P</b>
22 <sup>3</sup> / <sub>8</sub> (568mm) x 32 <sup>1</sup> / <sub>4</sub> (819mm) x 41 <sup>7</sup> / <sub>8</sub> (1064mm)	27" (686mm)	Passive Lock	Standard	<b>FL27P</b>
22 <sup>3</sup> / <sub>8</sub> (568mm) x 32 <sup>1</sup> / <sub>4</sub> (819mm) x 44 <sup>7</sup> / <sub>8</sub> (1140mm)	30" (762mm)	Passive Lock	Standard	<b>FL30P</b>
22 <sup>3</sup> / <sub>8</sub> (568mm) x 28 <sup>7</sup> / <sub>8</sub> (734mm) x 34 <sup>7</sup> / <sub>8</sub> (886mm)	21" (533mm)	Passive Lock	Narrow	<b>FLN21P</b>
22 <sup>3</sup> / <sub>8</sub> (568mm) x 28 <sup>7</sup> / <sub>8</sub> (734mm) x 38 <sup>7</sup> / <sub>8</sub> (988mm)	24" (610mm)	Passive Lock	Narrow	<b>FLN24P</b>
22 <sup>3</sup> / <sub>8</sub> (568mm) x 28 <sup>7</sup> / <sub>8</sub> (734mm) x 41 <sup>7</sup> / <sub>8</sub> (1064mm)	27" (686mm)	Passive Lock	Narrow	<b>FLN27P</b>
22 <sup>3</sup> / <sub>8</sub> (568mm) x 28 <sup>7</sup> / <sub>8</sub> (734mm) x 44 <sup>7</sup> / <sub>8</sub> (1140mm)	30" (762mm)	Passive Lock	Narrow	<b>FLN30P</b>
22 <sup>3</sup> / <sub>8</sub> (568mm) x 32 <sup>1</sup> / <sub>4</sub> (819mm) x 34 <sup>7</sup> / <sub>8</sub> (886mm)	21" (533mm)	Key Lock	Standard	<b>FL21K</b>
22 <sup>3</sup> / <sub>8</sub> (568mm) x 32 <sup>1</sup> / <sub>4</sub> (819mm) x 38 <sup>7</sup> / <sub>8</sub> (988mm)	24" (610mm)	Key Lock	Standard	<b>FL24K</b>
22 <sup>3</sup> / <sub>8</sub> (568mm) x 32 <sup>1</sup> / <sub>4</sub> (819mm) x 41 <sup>7</sup> / <sub>8</sub> (1064mm)	27" (686mm)	Key Lock	Standard	<b>FL27K</b>
22 <sup>3</sup> / <sub>8</sub> (568mm) x 32 <sup>1</sup> / <sub>4</sub> (819mm) x 44 <sup>7</sup> / <sub>8</sub> (1140mm)	30" (762mm)	Key Lock	Standard	<b>FL30K</b>
22 <sup>3</sup> / <sub>8</sub> (568mm) x 28 <sup>7</sup> / <sub>8</sub> (734mm) x 34 <sup>7</sup> / <sub>8</sub> (886mm)	21" (533mm)	Key Lock	Narrow	<b>FLN21K</b>
22 <sup>3</sup> / <sub>8</sub> (568mm) x 28 <sup>7</sup> / <sub>8</sub> (734mm) x 38 <sup>7</sup> / <sub>8</sub> (988mm)	24" (610mm)	Key Lock	Narrow	<b>FLN24K</b>
22 <sup>3</sup> / <sub>8</sub> (568mm) x 28 <sup>7</sup> / <sub>8</sub> (734mm) x 41 <sup>7</sup> / <sub>8</sub> (1064mm)	27" (686mm)	Key Lock	Narrow	<b>FLN27K</b>
22 <sup>3</sup> / <sub>8</sub> (568mm) x 28 <sup>7</sup> / <sub>8</sub> (734mm) x 44 <sup>7</sup> / <sub>8</sub> (1140mm)	30" (762mm)	Key Lock	Narrow	<b>FLN30K</b>

To configure a cart to your exact specifications, visit [www.metroconfigurator.com](http://www.metroconfigurator.com)



FL420

### Additional Security

Description	Cat. No.
Individual Drawer Seal Lock Bar — 36" (914mm) Cart	FL400 <sup>F</sup>
Individual Drawer Seal Lock Bar — 39" (991mm) Cart	FL401 <sup>F</sup>
Individual Drawer Seal Lock Bar — 42" (1067mm) Cart	FL402 <sup>F</sup>
Individual Drawer Seal Lock Bar — 45" (1143mm) Cart	FL403 <sup>F</sup>
Basic Keyless Entry Touch Pad with 10 year Battery	FL410*
Basic Keyless Entry Touch Pad with Auto Lock, Rechargeable	FL411* <sup>F</sup>
Touchpad Charger Adapter Kit - 90-264 VAC 47-63 Hz	FL419 <sup>F</sup>
Touchpad with LCD Screen, Auto Lock, USB Port (Card Reader Upgradable)	FL420* <sup>F</sup>
Software Manager for FL420	FL421
Proximity Card Reader for FL420	FL430** <sup>F</sup>
Bar Code Card Reader for FL420	FL431** <sup>F</sup>
Magnetic Card Reader for FL420	FL432** <sup>F</sup>

\*FL410, FL411, FL420 can only be ordered with a key locking cart.  
 \*\*Readers may not be compatible with all cards. Check with your Metro Representative.  
<sup>F</sup>Must be factory installed prior to shipment.



FL400-FL403

### Drawer, Shelf and Keyboard Shelf

Drawer pulls must be ordered with each drawer.

Description	Cat. No.
Lockable Drawer Cover	FL100 <sup>F</sup>
3" (76mm) Pull Out Shelf	FL101
Keyboard Tray	FL102 <sup>F</sup>
3" (76mm) Individual Locking Drawer for Narcotics Storage—Key Lock Cart	FL103KL <sup>F</sup>
3" (76mm) Individ. Locking Drawer for Narcotics Storage—Electronic Lock Cart	FL103EL <sup>F</sup>
6" (152mm) Drawer (no drawer pull)	FL106
9" (229mm) Drawer (no drawer pull)	FL109
12" (305mm) Drawer (no drawer pull)	FL112
Solid Bottom Shelf	FL120

<sup>F</sup>Inside Drawer Dimensions — 20 7/8" (514mm) wide x 17" (432mm) deep.  
<sup>F</sup>Must be factory installed prior to shipment.

### Drawer Pulls Colors

Order 1 drawer pull per drawer.

Description	Cat. No.
Drawer Pull — Code Blue	FL-CB
Drawer Pull — Red	FL-RD
Drawer Pull — Orange	FL-OR
Drawer Pull — Green	FL-GR
Drawer Pull — Yellow	FL-YL
Drawer Pull — Slate Blue	FL-SB
Drawer Pull — Violet	FL-VL
Drawer Pull — Pink	FL-PK
Drawer Pull — White	FL-WHT
Drawer Pull — Dark Taupe	FL-TPE

### DRAWER PULL COLORS

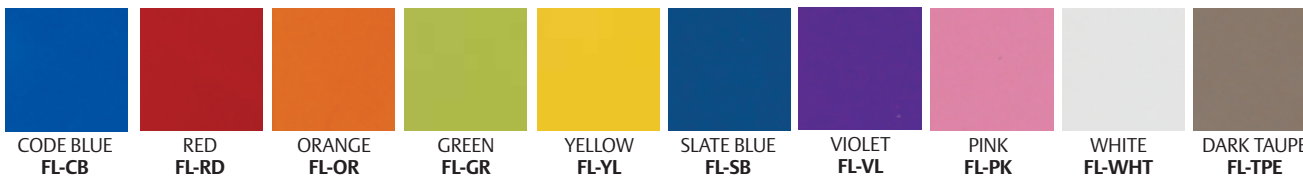

CODE BLUE FL-CB    RED FL-RD    ORANGE FL-OR    GREEN FL-GR    YELLOW FL-YL    SLATE BLUE FL-SB    VIOLET FL-VL    PINK FL-PK    WHITE FL-WHT    DARK TAUPE FL-TPE



FL101



FL102



FL151



FL159



FL190 (Label not included)

### Drawer Accessories



FL237



FL235



FL236, FL221



FL212

Description	Cat. No.
3" (76mm) Drawer Divider Kit (3 Long, 5 Short, 6 T-Clips)	FL113
6/9" (152/229mm) Drawer Divider Kit (2 Long, 5 Short)	FL116
Divider For FL131, 12 Pack 5" L (125mm)	FL132
3" (76mm) Egg Crate Style Drawer Divider Kit (Qty. 10 vertical, 5 horizontal)	FL141
6" (152mm) Egg Crate Style Drawer Divider Kit (Qty. 10 vertical, 5 horizontal)	FL142
3" (76mm) Drawer Tray Approximate 20" x 15" (508 x 381mm) with 6 Dividers 4 Short, 2 Long, Sheet of Blank Labels, 5 Security Bags	FL151
Lid for 6"(152mm) Drawer Tray	FL158
6" (152mm) Drawer Tray Approximate 19" x 15" (483 x 381mm) with Dividers 6 Short, 2 Long, 5 Security Bags	FL159
Long Divider Rails for FL151 2 Pack 15 1/2" L (394mm)	FL163
Short Divider for FL159 (3 Pack) 8" L (205mm)	FL164
Long Divider for FL159 (2 Pack) 14 3/4" L (375mm)	FL166
Short Divider for FL159 (3 Pack) 8" L (205mm)	FL167
Security Bags for 3" (76mm) Tray and 6" (152mm) Tray 20 Pack	FL183
Label Holder Set of 10 13 5/8" L (346mm)	FL190

### Side/Recessed Storage Accessories

Description	Cat. No.
Side Bin (1) — Locking 4 1/2" x 16 3/4" x 8 1/2" (117 x 426 x 216mm)	FL211*F
Side Bin (1) — Non-Locking 4 1/2" x 16 3/4" x 8 1/2" (117 x 426 x 216mm)	FL212
Waste Basket 28 Quart and Holder 14 1/2" x 10 7/8" x 15 3/8" (370 x 275 x 390mm)	FL221
Waste Basket 28 Quart	FL222
O <sub>2</sub> Tank Holder — All Size Carts - 5 1/2" (140mm) Diameter Tank	FL234-5
O <sub>2</sub> Tank Holder — All Size Carts — 4" (102mm) Diameter Tank	FL234
O <sub>2</sub> Tank Holder — 5"(1140mm)H Cart — 5 1/2" (140mm) Diameter Tank 9 3/8" x 5 1/2" x 19 1/4" (238 x 144 x 489mm)	FL235-5
O <sub>2</sub> Tank Holder — 45" (1140mm)H Cart — 4" (102mm) Diameter Tank 9 3/8" x 6 3/4" x 19 1/4" (238 x 172 x 489mm)	FL235
Glove Box Holder — Single 4" x 10 1/8" x 6 3/8" (101 x 258 x 162mm)	FL236
Glove Box Holder — Triple 4" x 10 1/8" x 18 3/8" (101 x 258 x 466mm)	FL237
Sharps Container Bracket — Non Locking 9 1/2" x 3 1/4" x 9 5/16" (241 x 83 x 237mm)	FL250
Lockable Sharps Container 4 3/4" x 13" x 19 7/8" (with glove box) x 11 3/8" (without Glove Box) (121 x 330 x 505 or 302mm)	FL251
Replacement Containers for FL251 — 20 5 Qt. Containers	FL252

\*Locking bins for keylock cart are available on the right. Locking bins for the passive lock cart are available on the left.

\*Must be factory installed prior to shipment.

\*\*For use on 45" H (1143mm) carts only.







FL314



FL315

## Cart Accessories

Description	Cat. No.
Rear Accessory Mount Brackets — 1 Pair	FL301 <sup>F</sup>
Cord Manager 1/2" x 21 3/4" x 1 1/4" (13 x 554 x 31mm)	FL302
Hospital Grade 6-Outlet Strip and Holder 2 3/4" x 4 1/4" x 23 1/4" (69 x 108 x 591mm)	FL305**
   	
FL305-EU	FL305-AUS
FL305-UK	FL305-IT
Side Shelf 12 1/2" x 15 1/4" x 4 1/4" (320 x 384 x 108mm)	LEC306
Articulating Arm — Laptop	FL310
Articulating Arm — Tablet	FL311
Articulating Arm — Monitor	FL318
Peel Pouch Container 3" x 6" x 18 1/4" (78 x 154 x 461mm)	FL312
Peel Pouch Holder 3" x 6" x 27 3/8" (78 x 154 x 695mm)	FL313
Pull Out Side Shelf 12 1/2" x 30 1/2" x 3/8" (322 x 775 x 10mm)	FL314 <sup>F</sup>
2HK I.V. Pole with Cart Mount 1/2" x 9 1/8" x 37" (max)*-25 1/4" (min)* (38 x 232 x 940-640mm)	FL315
4HK I.V. Pole with Cart Mount 5" x 7 1/8" x 37" (max)*-25 1/4" (min)* (127 x 183 x 940-640mm)	FL317
Plastic Security Seals 100 Pack	LEC320



FL310



FL315



FL510, FL546, FL544



FL510, FL583, FL581, FL582, FL586

<sup>F</sup>Must be factory installed.

\*Maximum, Minimum in relation to cart top

\*\*If outside North America add plug configuration to part number.

†Must be ordered on a 36"H (914mm) cart to accommodate I.V. pole, articulating arm or outlet strip.

## Overbridges and Overbridge Accessories

Description	Cat. No.
Overbridge with 2 Hanger Rails 1 1/4" x 26 1/8" x 19 7/8"-25 1/2" (32 x 665 x 504-649mm)	FL510
Overbridge with Top Shelf and Hanger Rail	FL515
Overbridge with 2 Shelves	FL520
Tilt Bin 3 for Overbridge — 9 1/2"(241mm)H x 7 3/4"(197mm)W x 23 3/4"(600mm)L	FL543
Tilt Bin 6 for Overbridge — 4 1/2"(114mm)H x 3 3/4"(92mm)W x 23 3/4"(600mm)L	FL546
Hanger Rail	FL550
Overbridge Bottom Shelf 14 1/2" x 31" (368 x 787mm)	FL559
Overbridge Top Shelf 14 1/2" x 31" (368 x 787mm)	FL560
2HK I.V. Pole with Universal Clamp — for Overbridge	FL563
4HK I.V. Pole with Universal Clamp — for Overbridge 9 1/8" x 28 1/4" x 19 7/8"-25 1/2" (232x718x504-649mm)	FL566
Universal Clamp	FL570
Short Utility Hook 4 Pack (Holds Peel Pouches, I.V. Bags, Stethoscopes, etc.)	FL571*
Chart Holder 4 3/4" x 11 1/2" x 9 1/4" (120 x 292 x 235mm)	FL576
Half-Size Utility Bin — 5 1/2"(140mm)H x 5 1/2"(140mm)W x 5 3/4"(146mm)L	FL581
Full-Size Utility Bin — 5 1/2"(140mm)H x 5 1/2"(140mm)W x 11 3/4"(292mm)L	FL582
Label/Tape Dispenser	FL583
Sharps Bracket Container	FL584*
Wire Supply Basket — 5"(127mm)H x 7"(178mm)W x 17"(432mm)L	FL585
Utility Bin with Cover (Pack of six)	FL586
Monitor Mounts for Overbridge	FL590

\*Fits on universal clamp in addition to a hanger rail.



**Lab Security Cart — 52.05**

Provides secure storage for animal cage, lab instrument, or hazardous chemical transport. Solid stainless steel shelf with raised ship's edge can be used as a work surface and can contain unwanted spills.

Width (in.) (mm)	Length (in.) (mm)	Height (in.) (mm)	Rating <sup>1</sup>		Description	Approx. Pkd. Wt.		Cat. No.			
			(lbs.)	(kg)		(lbs.)	(kg)				
24	610	30	760	39	990	600	273	Stainless steel security cart with flip-up door 5" (127mm) polyurethane casters	85	38.6	<b>SECMLAB*</b>

<sup>1</sup>Lab Security Cart features two stainless steel wire shelves, one stainless steel security module, and one stainless steel solid shelf. Cart comes standard with two brake casters (Cat. No. 5MPB) and two swivel casters (Cat. No. 5MP).

Lab Security Cart  
(shown with optional accessories)



**Utility Carts**

- Wire and solid shelves available.
- Choose between stainless and chrome finishes.
- Adjust shelves on 1" (25mm) increments.
- Various sizes and styles to choose from. (See pages 84-85)



Enclosed Lab Carts — 33.10

The functional design of Metro Enclosed Lab Carts maximizes usable inside storage space and provides superior maneuverability. Carts can be used wherever contents must be protected from an “unclean” environment.



Overall Width		Cabinet		Overall Height		Cabinet		Approx. Pkd. Wt.		Cat. No.	Cat. No.
(in.)	(mm)	(in.)	(mm)	(in.)	(mm)	(in.)	(mm)	(lbs.)	(kg)	with Stainless Casters	with Polymer Casters
32 <sup>7</sup> / <sub>8</sub>	835	27 <sup>1</sup> / <sub>4</sub>	692	38 <sup>1</sup> / <sub>4</sub>	972	28 <sup>1</sup> / <sub>2</sub>	724	115	52.27	CASE-L24*	CASE-L24P*
44 <sup>7</sup> / <sub>8</sub>	1140	39 <sup>1</sup> / <sub>4</sub>	997	38 <sup>1</sup> / <sub>4</sub>	972	28 <sup>1</sup> / <sub>2</sub>	724	186	84.5	CASE-L36*	CASE-L36P*
56 <sup>7</sup> / <sub>8</sub>	1445	51 <sup>1</sup> / <sub>4</sub>	1302	38 <sup>1</sup> / <sub>4</sub>	972	28 <sup>1</sup> / <sub>2</sub>	724	212	96.4	CASE-L48*	CASE-L48P*
32 <sup>7</sup> / <sub>8</sub>	835	27 <sup>1</sup> / <sub>4</sub>	692	57 <sup>1</sup> / <sub>8</sub>	1451	46 <sup>1</sup> / <sub>2</sub>	1181	162	73.6	CASE-H24*	CASE-H24P*

All units are 28<sup>1</sup>/<sub>2</sub>" (724mm) deep overall. Cabinet depth is 25<sup>1</sup>/<sub>2</sub>" (648mm).  
 \*Order shelves separately.

Optional Shelves (Wire Pullout, Wire Pullout with Rollers, Solid)

Cart	Shelf Size		Approx. Pkd. Wt. (with 2 brackets)		Cat. No. Wire Shelf	Approx. Pkd. Wt. (with 2 brackets)		Cat. No. Roller Shelf	Approx. Pkd. Wt. (with 2 brackets)		Cat. No. Solid Shelf
	(in.)	(mm)	(lbs.)	(kg)		(lbs.)	(kg)		(lbs.)	(kg)	
CASE-L24(P)	24x24	610x610	9	4.1	CCWS-24	12	5.5	CCROLWS-24	15	6.8	CCSS-24
CASE-L36(P)	24x36	610x914	13	5.9	CCWS-36	16	7.3	CCROLWS-36	19	8.6	CCSS-36
CASE-L48(P)	24x48	610x1219	19	8.6	CCWS-48	21	9.5	CCROLWS-48	25	11.3	CCSS-48
CASE-H24(P)	24x24	610x610	9	4.1	CCWS-24	12	5.5	CCROLWS-24	15	6.8	CCSS-24

Each shelf includes two attachment brackets.  
 Shelf weight capacity is 150 lbs. (68kg) evenly distributed.



Optional wire roller shelf, pulls out halfway, easily and quietly, even at the bottom level where accessibility is vital.



Ergonomically full length handles (on both sides of the low profile carts) allow for convenience in pushing or pulling from either end and provide better cart control.



Detachable brackets remove for faster and easier cleaning and drying. Brackets, which hold shelves, attach and detach quickly from “keyhole” slots for easy shelf adjustability at 2" (51mm) increments.



Double panel door provides optimum strength. Recessed latch eliminates a catch point. Two-door models have a center flange to stop splashes from entering cart.



Stainless Steel Caster Specially designed stainless steel casters provide easy maneuverability even through frequent cart washings. It features long wearing, shock absorbing polyurethane tread.



Polymer Caster The economical option to the stainless steel caster, it is cart washable, provides the same weight load capacity and is equipped with the same long-wearing polyurethane tread.



MetroMax i® Lab Storage Cart

- **Corrosion Proof** — The ultimate storage and transport system: Engineered polymers and Type 304 stainless are warranted against rust and corrosion for the life of the product.
- **Microban® antimicrobial product protection** — A Metro exclusive — is built into all shelves and touch points, inhibiting the growth of mold, mildew, and bacteria.
- **Cleanable** — Lift off grid and solid shelf mats are sized to fit into a sink making cleaning easy.
- **Flexible** — A range of shelf sizes, post heights and accessories allow you to “customize” the system to fit your requirements.

For more information, see pages 14-28.



Super Adjustable™ Super Erecta® Shelving — 10.01a

- **Adjustability:** Patented release lever means shelves can be quickly and easily adjusted at 1" (25mm) increments along the entire length of the post.
- **Unique Shelf Design:** Super Adjustable offers the patented shelf release method for fast and easy shelf adjustment.
- **Open-wire Construction:** Minimizes dust accumulation and allows a free circulation of air, greater visibility and light penetration.
- **Unique Post Design:** SiteSelect post design, with double grooves every 8" (203mm) provides a visual guide for positioning shelves.
- **Available in Type 304 stainless steel, durable chrome-plated and Metroseal 3 (corrosion resistant epoxy).**

For more information, see pages 36-39.

\*MICROBAN® and the MICROBAN® symbol are registered trademarks of the Microban Products Company, Huntersville, NC.

**Wall-Mounted Shelving — 10.40**

An ideal method for storing items overhead or above work surfaces.

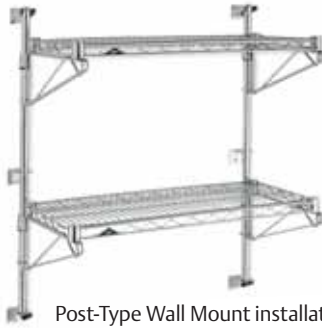

Post-Type Wall Mount installation (see pages 79-80)



SmartWall G3 (see pages 72-77)

**Metro® Top-Track High-Density Storage Systems — 9.12**

When adding space isn't an option, the answer is to make your existing space more efficient. Combines movable aisles and stationary end units — utilizing all available space.

- Metro Top-Track systems can increase storage capacity up to 50% and more by eliminating unnecessary aisle space.
- Mobile and stationary units attach to overhead tracks to increase storage capacity.
- Eliminates the need for costly facility expansion.
- Available in a variety of sizes.



Super Erecta Single Deep Top-Track System with SNC slide accessory and Metro totes.

See pages 88 and 92-96 for more information.

**qwikTRAK™ High-Density Storage**

The aluminum and stainless steel floor tracks provide a smooth, gliding surface for mobile units.

- Increase storage space by up to 50%.
- Heavy-duty mobile units are designed to move easily and store heavy weight loads.
- Floor tracks protect the floor from wear and tear and do not require to be mounted to the floor.
- Floor tracks compensate for rough or choppy floor surfaces.

Double-Deep Configurations can be created where two systems are joined together to increase the overall depth of the storage system for even greater storage capacity.

Choose the shelving type based on the application.

Both single- and double-deep systems can be used with Metro wire shelving (Super Erecta or Super Adjustable) and polymer shelving systems (MetroMax i and MetroMax Q). MetroMax i mobile qwikTRAK units can hold up to 1,200 lbs. (544kg). MetroMax Q, Super Adjustable, and Super Erecta mobile qwikTRAK units can hold up to 2,000 lbs. (907kg).



See pages 88, 90 and 91 for more information.



MXIV1



IVB1  
(shown with optional Divider)

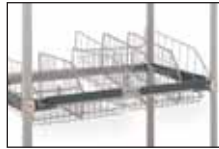

Baskets fit on frames level or at a 10° angle for easy viewing.

### MetroMax i® Gown and Bootie Storage

Baskets have semi-open front for easy access. Dividers adjust horizontally within the basket to accept various sizes. Continuous label holders identify basket contents.

Description	Height/Width/Length (in.) (mm)		Total Baskets Per Cart	Casters	Cat. No.
Open Cart	24x24x60	610x610x1524	4	*	<b>MXIV1</b>
Open Cart with Top Shelf	24x24x69	610x610x1753	4	*	<b>MXIV2</b>
Open Cart	24x42x60	610x1066x1524	8	†	<b>MXIV4</b>
Open Cart with Top Shelf	24x42x69	610x1066x1753	8	†	<b>MXIV5</b>
Open Cart	24x60x60	610x1524x1524	12	†	<b>MXIV6</b>
Open Cart with Top Shelf	24x60x69	610x1524x1753	12	†	<b>MXIV7</b>

\*Four 5" (127mm) poly casters; two swivel, two with brakes.  
†5" (127mm) poly casters on dolly frame; two swivel, one swivel with brake, and one rigid.

### Accessories

Description	(in.)	Size (mm)	Cat. No.
Basket* with Label Holder	18 1/2 x 24 1/2 x 10	470x622x254	<b>IVB1</b>
Divider	9	229	<b>IVBD</b>

\*Basket weight capacity is 35 lbs. (16kg). Finish is epoxy; color is taupe.

### Garment Rack – Upright and Wall Mount – 58.15

Racks are designed to provide efficient storage of Cleanroom garments. Hangers are spaced at 3" (75mm) intervals. Electro-polished, Type 304 stainless steel hangers are included.

- Type 304 stainless steel construction throughout.
- Open-wire design promotes laminar air flow.
- Adjustable stainless steel leveling feet provide floor mount or free standing option.
- Unique hanger capture mechanism and hanger design provide theft deterrence.



Garment Rack

#### Upright

Width/Length (in.) (mm)		No. of Hangers	Approx. Pkd. Wt. (lbs.) (kg)		Cat. No.
24x36	610x914	11	27	12.25	<b>GRU2436S</b>
24x48	610x1219	15	36	16.25	<b>GRU2448S</b>
24x60	610x1524	19	45	20.5	<b>GRU2460S</b>
24x72	610x1825	23	54	24.5	<b>GRU2472S</b>

#### Wall Mount

Width/Length (in.) (mm)		No. of Hangers	Approx. Pkd. Wt. (lbs.) (kg)		Cat. No.
24x36	610x914	11	20	9	<b>GRW2436S</b>
24x48	610x1219	15	22 1/2	10.2	<b>GRW2448S</b>
24x60	610x1524	19	27 1/2	12.5	<b>GRW2460S</b>
24x72	610x1825	23	32	14.5	<b>GRW2472S</b>

### Gowning Bench – 58.15

Heavy-duty, solid top bench provides a sturdy and comfortable gowning fixture.

- Top is manufactured from 14 gauge, Type 304 stainless steel.
- Stainless steel footplates provide floor mount or free-standing option.



Gowning Bench

Width/Length (in.) (mm)		Approx. Pkd. Wt. (lbs.) (kg)		Cat. No.
16x36	406x914	47 1/2	21.5	<b>GB1636S</b>
16x48	406x1219	55	25	<b>GB1648S</b>
16x60	406x1524	62 1/2	28.4	<b>GB1660S</b>
16x72	406x1825	70	31.8	<b>GB1672S</b>

☑ Indicates antimicrobial product.

### Super Erecta Shelf® All-Stainless Solid Shelving

- Solid shelving is available in four widths and six lengths.
- All-stainless, 18-gauge steel construction with 1/8" (3mm) ship's edge detail helps contain spills.
- All-stainless design, including stainless cast corners, can be used in cart wash and autoclave environments. Refer to autoclave guidelines on page 183.
- New accessories include high-temperature autoclave casters and autoclave cart covers.



All stainless solid shelf with stainless corners

### Solid Shelves

Width/Length (in.) (mm)		Approx. Pkd. Wt. (lbs.) (kg)		Cat. No. Stainless
14x24	355x610	10	4.5	1424NFS
14x30	355x760	12	5.4	1430NFS
14x36	355x914	14	6.4	1436NFS
14x42	355x1066	15	6.8	1442NFS
14x48	355x1219	17	7.7	1448NFS
14x60	355x1524	22	9.9	1460NFS
18x24	457x610	11	5.0	1824NFS
18x30	457x760	14	6.4	1830NFS
18x36	457x914	16	7.3	1836NFS
18x42	457x1066	18	8.2	1842NFS
18x48	457x1219	20	9.1	1848NFS
18x60	457x1524	24	10.9	1860NFS
21x24	530x610	13	5.9	2124NFS
21x30	530x760	15	6.8	2130NFS
21x36	530x914	18	8.2	2136NFS
21x42	530x1066	21	9.5	2142NFS
21x48	530x1219	23	10.4	2148NFS
21x60	530x1524	26	11.8	2160NFS
24x24	610x610	15	6.8	2424NFS
24x30	610x760	17	7.7	2430NFS
24x36	610x914	19	8.6	2436NFS
24x42	610x1066	21	9.5	2442NFS
24x48	610x1219	24	10.9	2448NFS
24x60	610x1524	31	14.0	2460NFS

**Important:** When ordering by components remember that stability decreases as the ratio of height to width increases. Units should be kept as wide and low as possible.  
**Note:** Demo corner sample can be obtained by ordering Cat. No. DEMO-NFS.



### Stainless Steel Shelf Ledges

Sturdy 4" (101mm) ledges contain items on shelves. Spring-clip tabs included for attachment.

Fits Shelf Length (in.) (mm)		Approx. Pkd. Wt. Per 6 Pieces (lbs.) (kg)		Cat. No. Stainless
14	355	7 1/2	3.4	L14WS
18	457	9	4.1	L18WS
21	530	10 1/2	4.7	L21WS
24	610	12	5.4	L24WS
30	760	13 1/2	6.0	L30WS
36	914	16 1/2	7.4	L36WS
42	1066	19 1/2	8.7	L42WS
48	1219	22 1/2	10.1	L48WS
60	1524	30	13.5	L60WS

\*Actual ledge length is approximately 1" (25mm) shorter than nominal shelf length/width.



4" (101mm) Ledges

### Stainless Steel Shelf Dividers

The easy way to keep shelves orderly. Eight inch (203mm) high dividers attach with spring clips (provided).

Fits Shelf Length (in.) (mm)		Approx. Pkd. Wt. Per 6 Pieces (lbs.) (kg)		Cat. No. Stainless
18	457	13 1/2	6.0	DD18FS
24	610	16 1/2	7.4	DD24FS



Shelf Dividers

### A. For Stationary Shelving Applications

Combine required shelf sizes from previous page with stainless posts (4 required), below. Stainless posts are fitted with adjustable stainless steel leveling bolts to compensate for uneven surfaces.

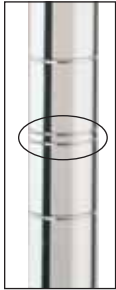

SiteSelect™ Posts are grooved at 1" (25mm) increments and numbered at 2" (50mm) increments. Posts are double-grooved every 8" (203mm) for easy identification.

Height*		Approx. Pkd. Wt.		Cat. No. Stainless
(in.)	(mm)	(lbs.)	(kg)	
7 1/2	195	1/2	0.3	—
14 1/2	370	1	0.5	13PS
27 1/2	700	1 3/4	0.75	27PS
34 1/2	875	2	0.9	33PS
54 9/16	1385	3	1.4	54PS
62 9/16	1590	3 1/2	1.6	63PS
74 5/8	1895	4	1.8	74PS
86 5/8	2200	5	2.3	86PS
96 5/8	2454	5 1/2	2.5	—

\*Height includes leveling bolt and cap.

### B. For Mobile Applications

Combine required shelf sizes from previous page with stainless mobile posts (4), below. Mobile posts accept a wide range of Metro stem casters. Refer to page 187, Caster Selection Guide, for caster selection options or contact your local Metro Rep for more information.

Height		Approx. Pkd. Wt.		Cat. No. Stainless
(in.)	(mm)	(lbs.)	(kg)	
27 1/2	699	1 3/4	0.75	27UPS
33 7/8	861	2	0.9	33UPS
54	1370	3	1.4	54UPS
62	1575	3 1/2	1.6	63UPS
74	1880	4	1.8	74UPS
86	2185	4.5	2.0	86UPS

These posts come without leveling bolt assembly to accommodate stem casters.

### C. For Cart Wash (Mobile) Applications

Combine required shelf sizes with stainless swedged posts (4), below. Stainless steel cart washable casters are required for cart wash applications. Refer to chart below for recommended caster series.

#### Swedged Posts

Description	Dimensions (in./mm)		Cat. No.
Stem Caster Post	33	875	33UPS-SW
Stem Caster Post	54	1370	54UPS-SW
Stem Caster Post	63	1600	63UPS-SW

### Stainless Steel Cart-Washable Stem Casters

Stem casters are shipped with donut bumpers.



5MDGSA

Wheel Diameter (in./mm)	Face (in./mm)	Load Rating (lbs./kg)		Type	Wheel Tread	Approx. Pkd. Wt. (lbs./kg)		Cat. No.
5 127	1 1/4 32	150	68	Swivel	High Modulus	2 1/2	1.1	5MDGSA
5 127	1 1/4 32	150	68	Brake	High Modulus Donut	2 5/8	1.17	5MDBGSA
5 127	1 1/4 32	150	68	Rigid	High Modulus Donut	2 3/8	1.08	5MDRGSA
5 127	1 1/4 32	300	135	Swivel	Polyurethane	2 1/8	.94	5MPGSA
5 127	1 1/4 32	300	135	Brake	Polyurethane	2 1/4	1	5MPBGSA
5 127	1 1/4 32	300	135	Rigid	Polyurethane	2	.9	5MPRGSA

**Note 1:** Load Height for all 5MD and 5MP casters — 6 7/32" ± 1/16" (155 ± 1.5mm).  
**Note 2:** All casters are grease sealed with zerk fittings in swivel and axle.  
**Note 3:** Brakes are foot-operated.

### D. For Autoclave (Mobile) Applications

Combine required shelf sizes from previous page with stainless swedged posts (4 required), above. Aluminum split sleeves (Cat. No. 9986S) must be used for autoclave applications. High temperature stem casters must be selected from chart below.

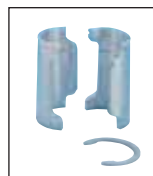

9986S

#### Aluminum Split Sleeves

Improved design is easier to install. For high temperature, over the road, or conductive applications. Stainless steel retainer rings included. One bag required per shelf; 4 pairs per bag.

	Cat. No.
Aluminum Split Sleeves with Stainless Rings	9986S



5MHTP



5MHTPB



5MHTN



5MHTNB

#### High-temperature Autoclave Stem Casters

Type	Wheel Tread	Load Rating	Cat. No.
Swivel	Hi-temp Phenolic	300	5MHTP
Brake	Hi-temp Phenolic	300	5MHTPB
Swivel	Hi-temp Nylon	300	5MHTN
Brake	Hi-temp Nylon	300	5MHTNB

**Note:** Casters are temperature rated for up to 300°F (149°C)

D. For Autoclave (Mobile) Applications (continued)

Autoclavable Cage Racks

- Preconfigured, autoclavable cage racks available in two footprints — 18x60 (457x1524mm) and 24x60 (610x1524mm).
- Units are 69" (1753mm) high, including casters. **Casters must be ordered separately.**
- Carts come standard with swedged posts and aluminum split sleeves.

Width/Length/Height (in.) (mm)		Approx. Pkd. Wt. (lbs.) (kg)		Description	Cat. No.
18x60x69	457x1524x1753	136	61.7	5-shelf, 18" (457mm) wide cage rack	LC5S1860
24x60x69	610x1524x1753	166	75.3	5-shelf, 24" (610mm) wide cage rack	LC5S2460

**Note:** To build a cage rack according to specific requirements, follow instructions (D) on previous page. Refer to Autoclave guidelines, below, for important checklist to follow.

See page 187 for Caster Selection.



LC5S2460  
(casters sold separately)

Autoclave Cage Rack Covers

Width/Length/Height (in.) (mm)		Approx. Pkd. Wt. (lbs.) (kg)		Description	Cat. No.
20x62x61.5	508x1575x1562	6.0	2.7	Autoclavable cart cover for 18" (457mm) wide Cage Rack	LC1860AC
26x62x61.5	660x1575x1562	7.0	3.2	Autoclavable cart cover for 24" (610mm) wide Cage Rack	LC2460AC

**Note:** Autoclave cart covers are rated for approximately 70 cycles per cover.



LC5S2460 with autoclave cart cover  
(casters sold separately)

Autoclavable Lab Carts

- Preconfigured, autoclavable Lab carts are available in two footprints — 18x24 (457x610mm) and 24x36 (610x914mm).
- Choose between 2- and 3-shelf models
- Units are 39" (991mm) high, including casters. **Casters must be ordered separately.**
- Carts come standard with swedged posts and aluminum split sleeves.

Width/Length/Height (in.) (mm)		Approx. Pkd. Wt. (lbs.) (kg)		Description	Cat. No.
18x24x39	457x610x991	25.0	11.3	2-shelf, 18" (457mm) wide Lab cart	LC2S1824
18x24x39	457x610x991	37.5	17.0	3-shelf, 18" (457mm) wide Lab cart	LC3S1824
24x36x39	610x914x991	46.5	21.1	2-shelf, 24" (610mm) wide Lab cart	LC2S2436
24x36x39	610x914x991	65.5	29.7	3-shelf, 24" (610mm) wide Lab cart	LC3S2436

**Note:** To build a lab cart according to specific requirements, follow instructions (D) on previous page. Refer to Autoclave guidelines, below, for important checklist to follow.

See page 187 for Caster Selection.



LC2S1824  
(casters sold separately)

Autoclave Lab Cart Covers

Width/Length/Height (in.) (mm)		Approx. Pkd. Wt. (lbs.) (kg)		Description	Cat. No.
20x26x33.5	508x660x851	3.0	1.4	Autoclavable cart cover for 18" (457mm) wide Cage Rack	LC1824AC
26x38x33.5	660x965x851	3.5	1.6	Autoclavable cart cover for 24" (610mm) wide Cage Rack	LC2436AC

**Note:** Autoclave cart covers are rated for approximately 70 cycles per cover.

Autoclave Application Guidelines

When stainless solid shelving, as part of a mobile shelving unit, is used in an autoclave, the following Metro product guidelines are recommended to ensure optimal product performance and longevity:  
 Stainless, swedged posts with aluminum post caps must be utilized [part numbers 33/54/63UPS-SW]  
 Aluminum split sleeves [part number 9986S] with stainless rings should be used to mount solid stainless shelves.  
 Select either hi-temp phenolic casters or hi-temp nylon casters for application. These casters are designed specifically for autoclave environments. Bumpers should not be used as they are not designed to withstand autoclave temperature ranges.



Feed Cart  
(One Tote Capacity)



Feed Cart  
(Two Tote Capacity)



Cover Holder (shown mounted on Cart with one Tote Cover)

Lab Animal Feed (LAR) Carts — 52.05

LAR Feed Carts are designed to store and transport animal feed. Stainless steel finish provides superior corrosion resistance, while compact footprint makes it easy to maneuver in and around tight lab spaces. Tote with snap-on cover included.

- Super Erecta® construction makes units easy to assemble with absolute rigidity, and makes relocation of shelves quick and simple.
- Wire Shelves: Bright, modern, sanitary appearance. Open construction minimizes dust accumulation, maximizes visibility and air circulation.

Width (in.)	Length (in.)	Height (in.)	Rating <sup>1</sup> (lbs.)	Rating <sup>1</sup> (kg)	Description	Approx. Pkd. Wt. (lbs.)	Approx. Pkd. Wt. (kg)	Cat. No.	
18	457	24	610	38	965	375	171	Light-duty feed cart One tote capacity/shelf 4" (102mm) resilient casters <sup>2</sup>	42 18.7 LAR1
24	610	36	914	39	990	600	273	Heavy-duty feed cart Two tote capacity/shelf 5" (127mm) polyurethane casters <sup>2</sup>	65 29.2 LAR2

<sup>1</sup>Cart load rating listed is based on an evenly distributed load.

<sup>2</sup>Cat. No. LAR1 features four L4D series swivel casters with resilient rubber tread. Cat. No. LAR2 features four 5MP series swivel casters with polyurethane tread.

Refer to page 185 for information on Metro's Polymer LAR Feed Carts.

Accessories

Durable, Metro totes provide clean and secure storage for animal feed. Totes are injection-molded from polypropylene material, are stackable, and can be combined with snap-on covers and cardholders for security and identification of contents.

White Tote Box

(in.)	Outside Dimensions		Bottom		Inside Dimensions		Cat. No.
	Top	Length/Width/Height (mm)	(in.)	(mm)	Length/Width/Height (in.)	Bottom (mm)	
22.5x17.5x12	572x445x305	21x16	533x406	20.2x15.1x11.5	513x384x292	MTB93120W	

**Note 1:** All outside dimensions have an overall tolerance of (+/-) .050". All inside dimensions have an overall tolerance of (+/-) .100"

**Note 2:** Tote not recommended for freezer environments (temperatures lower than -20°F [-29°C]).

White Snap-on Cover

Length (in.)	Outside Dimensions		Height (in.)	Cat. No.
	Width (in.)	Height (mm)		
22.5	572	17.5	445	1.25 32 CO93000W

Tote Box Cardholders

Material	Inside Dimensions				Cat. No.
	Length (in.)	Width (mm)	Height (in.)	Height (mm)	
Polypropylene	4.5	114.3	8	203	OP2501CLR
Polypropylene	2 <sup>11</sup> / <sub>16</sub>	60.6	5	127	OP2535CLR

Cover Holder

Stainless steel wire cover holder provides a convenient storage option for tote box covers when not in use. Accessory easily mounts on any Super Erecta® based wire shelf.

Width (in.)	Length (in.)	Depth (in.)	Approx. Carton Wt. (lbs.)	Approx. Carton Wt. (kg)	Cat. No.
18 <sup>1</sup> / <sub>2</sub>	470	18 <sup>1</sup> / <sub>4</sub>	464	4 101	6 2.7 LAR-CH



**Bow-Tie™ Dunnage Racks — 9.09**

- Racks join together easily without tools in “end-to-end” and “back-to-back” configurations with the exclusive Bow-Tie™ feature.
- Rust and corrosion-proof polymer construction.
- Heavy-duty construction gives racks the strength to hold up to 1,500 lbs. (683kg) for 30” (760mm) and 36” (914mm) long racks, and 3,000 (1365kg) for 48” (1219mm) and 60” (1524mm) racks.
- Available with Microban™\* Antimicrobial Product Protection — see page 97.

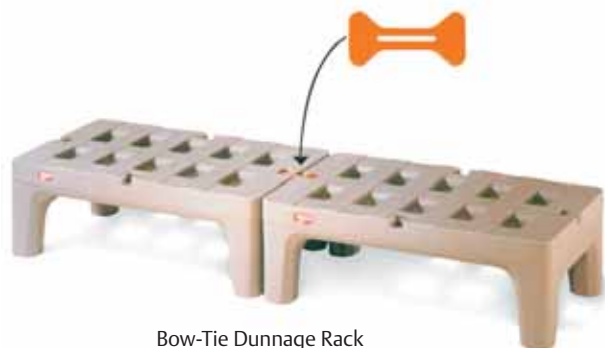

Bow-Tie Dunnage Rack

For more information, see page 97.

**Metro Bulk Feed Cart — 13.37**

- Use for bulk animal feed storage.
- Features unique patented multi-position lid which opens to 19 1/2"x12" (495x305mm).
- Double wall and deep insulation will hold ice for extended periods.
- Rust and corrosion-proof polymer construction. Large rear wheels and front swivel casters for easy mobility.



Feed Cart

Width/Depth/Height (in.)		Capacity (lbs.) (kg)		Casters	Cat. No.
22 1/2	28 1/4	33 1/2	125 57	8" (203mm) rear; 5" (127mm) front (1 locking)	<b>IC125</b>

\*MICROBAN® and the MICROBAN® symbol are registered trademarks of the Microban Products Company, Huntersville, NC.

Stainless Lab Worktables — 52.03

- Corrosion-proof performance — stainless steel construction throughout.
- Easily cleaned smooth surfaces. Mobile units can be easily moved to clean behind table area.
- Available top materials include Type 304 stainless and TRESPA Phenolic resin (black or gray). Refer to chart below for more information.
- Choose from a wide range of accessories and caster options (pages 187-188) to customize table.

**Note:**

Mobile posts include an adaptor insert that will accept Metro 5" (127mm) stem casters.

Use Area	Epoxy Resin	Phenolic Resin	Stainless Steel	Characteristics	Epoxy Resin	Phenolic Resin	Stainless Steel
	2				Heat Resistance	Excellent	Fair*
Low chemical use				Abrasion Resistance	Good	Excellent	Good
Moderate chemical use	X	X		Impact Resistance	Good	Excellent	Good
High chemical use		X	X	Strength	Good	Excellent	Good
				Stain Resistance	Good	Good	Good

\*Discolor with high heat  
 Note: Phenolic resin and stainless are offered as top options for this table system. Epoxy resin information is shown for comparison only.

**Definitions:**

**Phenolic resin:** Compression molded of organic fiber-reinforced phenolic core with an integrally cured thermoset resin surface. Stronger than Epoxy resin over a span, and not as brittle.

**Stainless Steel:** Worksurfaces are fabricated from Type 304 stainless steel which provides excellent protection in corrosive environments.

**Epoxy resin:** Epoxy resins, silica, organic fillers, and inert hardeners are cast in forms and cured to a uniform mixture throughout.

Select Table Style from Chart Below and Following Page:

Lab Tables with Stainless Island Top and Solid HD Shelf



LTSM30IS with casters (ordered separately)

Width (in.)	Length (mm)	Width (mm)	Length (mm)	Work Surface Height		Approx. Pkd. Wt. (lbs.) (kg)		Cat. No. Stationary	Cat. No. Mobile*	
				Stationary (in.)	Mobile (mm)	Stationary	Mobile			
30.000	762	29.750	755	35.375	898	35.188	893	65 30	LTS30IS	LTSM30IS
30.000	762	35.750	908	35.375	898	35.188	893	80 36	LTS36IS	LTSM36IS
30.000	762	47.750	1212	35.375	898	35.188	893	103 47	LTS48IS	LTSM48IS
30.000	762	59.750	1517	35.375	898	35.188	893	140 63	LTS60IS	LTSM60IS

Leveling feet on stationary units have 1.250 (31mm) vertical adjustment.  
**\*Casters ordered separately.** Refer to Caster Selection Guide (page 187) for more information.  
 Stainless Lab Tables are load rated at 50 lbs. per sq. foot (.024kg per sq. cm) up to a maximum of 600 lbs. (273kg) assuming evenly distributed load and caster specification meets requirement.  
**Note:** Mobile posts include an adaptor insert that will accept Metro 5" (127mm) stem casters.

Lab Tables with Stainless Island Top and 3-Sided Frame



LTSM60UIS with optional accessories and casters

Width (in.)	Length (mm)	Width (mm)	Length (mm)	Work Surface Height		Approx. Pkd. Wt. (lbs.) (kg)		Cat. No. Stationary	Cat. No. Mobile*	
				Stationary (in.)	Mobile (mm)	Stationary	Mobile			
30.000	762	29.750	755	35.375	898	35.188	893	58 26	LTS30UIS	LTSM30UIS
30.000	762	35.750	908	35.375	898	35.188	893	70 32	LTS36UIS	LTSM36UIS
30.000	762	47.750	1212	35.375	898	35.188	893	91 41	LTS48UIS	LTSM48UIS
30.000	762	59.750	1517	35.375	898	35.188	893	119 54	LTS60UIS	LTSM60UIS

Leveling feet on stationary units have 1.250 (31mm) vertical adjustment.  
**\*Casters ordered separately.** Refer to Caster Selection Guide (page 187) for more information.  
 Stainless Lab Tables are load rated at 50 lbs. per sq. foot (.024kg per sq. cm) up to a maximum of 600 lbs. (273kg) assuming evenly distributed load and caster specification meets requirement.  
**Note:** Mobile posts include an adaptor insert that will accept Metro 5" (127mm) stem casters.

Lab Tables with Stainless Backsplash Top and Solid HD Shelf



LTS30US with optional accessory wire shelf

Width (in.)	Length (mm)	Width (mm)	Length (mm)	Work Surface Height		Approx. Pkd. Wt. (lbs.) (kg)		Cat. No. Stationary	Cat. No. Mobile*	
				Stationary (in.)	Mobile (mm)	Stationary	Mobile			
30.000	762	29.750	755	35.375	898	35.188	893	65 30	LTS30S	LTSM30S
30.000	762	35.750	908	35.375	898	35.188	893	80 36	LTS36S	LTSM36S
30.000	762	47.750	1212	35.375	898	35.188	893	103 47	LTS48S	LTSM48S
30.000	762	59.750	1517	35.375	898	35.188	893	140 63	LTS60S	LTSM60S

Leveling feet on stationary units have 1.250 (31mm) vertical adjustment.  
**\*Casters ordered separately.** Refer to Caster Selection Guide (page 187) for more information.  
 Stainless Lab Tables are load rated at 50 lbs. per sq. foot (.024kg per sq. cm) up to a maximum of 600 lbs. (273kg) assuming evenly distributed load and caster specification meets requirement.  
**Note:** Mobile posts include an adaptor insert that will accept Metro 5" (127mm) stem casters.

Lab Tables with Stainless Backsplash and 3-Sided Frame

Width (in.)	Length (mm)	Width (mm)	Length (mm)	Work Surface Height		Approx. Pkd. Wt. (lbs.) (kg)		Cat. No. Stationary	Cat. No. Mobile*	
				Stationary (in.)	Mobile (mm)	Stationary	Mobile			
30.000	762	29.750	755	35.375	898	35.188	893	58 26	LTS30US	LTSM30US
30.000	762	35.750	908	35.375	898	35.188	893	70 32	LTS36US	LTSM36US
30.000	762	47.750	1212	35.375	898	35.188	893	91 41	LTS48US	LTSM48US
30.000	762	59.750	1517	35.375	898	35.188	893	119 54	LTS60US	LTSM60US

Leveling feet on stationary units have 1.250 (31mm) vertical adjustment.  
**\*Casters ordered separately.** Refer to Caster Selection Guide (page 187) for more information.  
 Stainless Lab Tables are load rated at 50 lbs. per sq. foot (.024kg per sq. cm) up to a maximum of 600 lbs. (273kg) assuming evenly distributed load and caster specification meets requirement.  
**Note:** Mobile posts include an adaptor insert that will accept Metro 5" (127mm) stem casters.

## Stainless Lab Worktables — 52.03

Lab Tables with Black Phenolic Top and Solid HD Shelf (Backsplash accessory ordered separately)

Width (in.)	Length (mm)	Width (in.)	Length (mm)	Work Surface Height		Approx. Pkd. Wt. (lbs.) (kg)	Cat. No. Stationary	Cat. No. Mobile*	
				Stationary (in.)	Mobile (mm)				
30.000	762	29.750	755	36.000	914	35.875 911	77 35	LTS30PB	LTSM30PB
30.000	762	35.750	908	36.000	914	35.875 911	92 41	LTS36PB	LTSM36PB
30.000	762	47.750	1212	36.000	914	35.875 911	113 51	LTS48PB	LTSM48PB
30.000	762	59.750	1517	36.000	914	35.875 911	141 64	LTS60PB	LTSM60PB



LTSM30PB

Leveling feet on stationary units have 1.250 (31mm) vertical adjustment.

\*Casters ordered separately. Refer to Caster Selection Guide (below) for more information.

Stainless Lab Tables are load rated at 50 lbs. per sq. foot (.024kg per sq. cm) up to a maximum of 600 lbs. (273kg) assuming evenly distributed load and caster specification meets requirement.

Note: Mobile posts include an adaptor insert that will accept Metro 5" (127mm) stem casters.

## Stainless Tables with Black Phenolic Top and 3-Sided Frame

(Backsplash accessory ordered separately)

Width (in.)	Length (mm)	Width (in.)	Length (mm)	Work Surface Height		Approx. Pkd. Wt. (lbs.) (kg)	Cat. No. Stationary	Cat. No. Mobile*	
				Stationary (in.)	Mobile (mm)				
30.000	762	29.750	755	36.000	914	35.875 911	70 32	LTS30UPB	LTSM30UPB
30.000	762	35.750	908	36.000	914	35.875 911	82 37	LTS36UPB	LTSM36UPB
30.000	762	47.750	1212	36.000	914	35.875 911	101 46	LTS48UPB	LTSM48UPB
30.000	762	59.750	1517	36.000	914	35.875 911	120 54	LTS60UPB	LTSM60UPB



LTSM60UPB with accessories, casters, backsplash, and Starsys™ cart

Leveling feet on stationary units have 1.250 (31mm) vertical adjustment.

\*Casters ordered separately. Refer to Caster Selection Guide (below) for more information.

Stainless Lab Tables are load rated at 50 lbs. per sq. foot (.024kg per sq. cm) up to a maximum of 600 lbs. (273kg) assuming evenly distributed load and caster specification meets requirement.

Note: Mobile posts include an adaptor insert that will accept Metro 5" (127mm) stem casters.

## Stainless Tables with Gray Phenolic Top and Solid HD Shelf

(Backsplash accessory ordered separately)

Width (in.)	Length (mm)	Width (in.)	Length (mm)	Work Surface Height		Approx. Pkd. Wt. (lbs.) (kg)	Cat. No. Stationary	Cat. No. Mobile*	
				Stationary (in.)	Mobile (mm)				
30.000	762	29.750	755	36.000	914	35.875 911	77 35	LTS30PG	LTSM30PG
30.000	762	35.750	908	36.000	914	35.875 911	92 41	LTS36PG	LTSM36PG
30.000	762	47.750	1212	36.000	914	35.875 911	113 51	LTS48PG	LTSM48PG
30.000	762	59.750	1517	36.000	914	35.875 911	141 64	LTS60PG	LTSM60PG



LTSM30PG

Leveling feet on stationary units have 1.250 (31mm) vertical adjustment.

\*Casters ordered separately. Refer to Caster Selection Guide (below) for more information.

Stainless Lab Tables are load rated at 50 lbs. per sq. foot (.024kg per sq. cm) up to a maximum of 600 lbs. (273kg) assuming evenly distributed load and caster specification meets requirement.

Note: Mobile posts include an adaptor insert that will accept Metro 5" (127mm) stem casters.

## Stainless Tables with Gray Phenolic Top and 3-Sided Frame

(Backsplash accessory ordered separately)

Width (in.)	Length (mm)	Width (in.)	Length (mm)	Work Surface Height		Approx. Pkd. Wt. (lbs.) (kg)	Cat. No. Stationary	Cat. No. Mobile*	
				Stationary (in.)	Mobile (mm)				
30.000	762	29.750	755	36.000	914	35.875 911	70 32	LTS30UPG	LTSM30UPG
30.000	762	35.750	908	36.000	914	35.875 911	82 37	LTS36UPG	LTSM36UPG
30.000	762	47.750	1212	36.000	914	35.875 911	101 46	LTS48UPG	LTSM48UPG
30.000	762	59.750	1517	36.000	914	35.875 911	120 54	LTS60UPG	LTSM60UPG



LTSM60UPG with accessories, casters, backsplash, and Starsys™ cart

Leveling feet on stationary units have 1.250 (31mm) vertical adjustment.

\*Casters ordered separately. Refer to Caster Selection Guide (below) for more information.

Stainless Lab Tables are load rated at 50 lbs. per sq. foot (.024kg per sq. cm) up to a maximum of 600 lbs. (273kg) assuming evenly distributed load and caster specification meets requirement.

Note: Mobile posts include an adaptor insert that will accept Metro 5" (127mm) stem casters.

For Stainless Steel Mobile Worktables, Select Appropriate Casters from Chart Below.

(Four brake casters are recommended for maximum table stability)

### Caster Selection Guide

Caster Series	Wheel Material	Rollability	Floor Protection	Noise	Load Rating (lbs.) (kg)		Corrosion Resistance	Cart Washable	Antimicrobial Additive in Wheel
5MDA/5MDBA (brake)	High Modulus Rubber	Good	Good	Low	250	114	Low	No	No
5MP/5MPB (brake)	Polyurethane	Good	Good	Moderate	300	137	Low	No	No
5PC/5PCB (brake)	Polyurethane	Good	Good	Moderate	300	137	High	No	No
5PCM/5PCBM (brake)	Polyurethane	Good	Good	Moderate	300	137	High	No	Yes
5MPGSA/5MPGSA (brake)	Polyurethane	Good	Good	Moderate	300	137	High	Yes	No

NOTE: The total weight of the equipment and its load should not exceed three times the load rating per caster. Additional stem casters, in various sizes and wheel materials, are available. Contact your Metro rep for more information.



5MDA



5MP



5PCB



5PCBM



5MPGSA

Note: Use heavy-duty mobile post adapter (Cat. No. 9974HDP-4) to convert HD Stationary post to accept any standard Metro 5" (127mm) series casters (shown above).

Stainless Lab Worktable Accessories — 52.03

Backsplash

4" (102mm) high. Attaches to phenolic table top (page 187), using pre-drilled holes. Match length and color with selected countertop.



L30BSG

Length (in.)	Length (mm)	Approx. Pkd. Wt. (lbs.) (kg)		Cat. No. Black	Cat. No. Gray
27 <sup>3</sup> / <sub>4</sub>	705	5.5	2.5	LT30BSB	LT30BSG
33 <sup>3</sup> / <sub>4</sub>	875	6.5	2.9	LT36BSB	LT36BSG
45 <sup>3</sup> / <sub>4</sub>	1162	7.5	3.4	LT48BSB	LT48BSG
57 <sup>3</sup> / <sub>4</sub>	1466	9.5	4.3	LT60BSB	LT60BSG

Wire Shelf

Stainless or Epoxy-coated shelves available.



LT30WS

Length (in.)	Length (mm)	Approx. Pkd. Wt. (lbs.) (kg)		Cat. No. Stainless	Cat. No. Epoxy Coated
22 <sup>3</sup> / <sub>8</sub>	568	6	2.7	LT30WS	LT30WE
28 <sup>3</sup> / <sub>8</sub>	720	7.5	3.4	LT36WS	LT36WE
40 <sup>3</sup> / <sub>8</sub>	1025	10	4.5	LT48WS	LT48WE
52 <sup>3</sup> / <sub>8</sub>	1330	12	5.4	LT60WS	LT60WE

**Note:** Shelves are load rated for a maximum of 150 lbs. (68kg).



LTSKB

Stainless Keyboard Tray

Fits 48" and 60" (1219 and 1524mm) table lengths

Cat. No. **LTSKB**

Note: Stainless keyboard tray and stainless drawer will both fit 60" (1524mm) long table.



LTSD6

Stainless Drawer

Fits 30", 36", 48" and 60" (760, 914, 1219 and 1524mm) table lengths

Cat. No. **LTSD6**

Note: Stainless keyboard tray and stainless drawer will both fit 60" (1524mm) long table.



LTFMA

Surface Mount Swing Arm for Flat Monitor

Cat. No. **LTFMA**

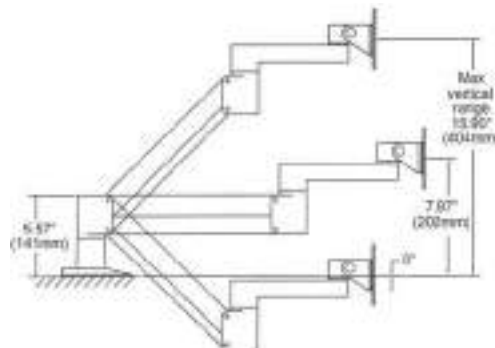
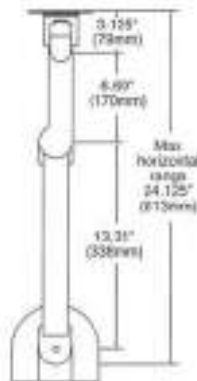
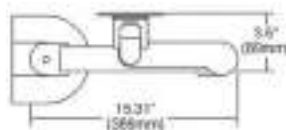

MetroMax i Lab Worktables — 52.01

- Advanced polymer construction provides excellent corrosion-resistance performance for the most corrosive lab environments.
- Table features smooth surfaces that are easy-to-clean. Mobile units can be easily moved to clean behind table area.
- Available top materials include Type 304 stainless and TRESPA phenolic resin (black or gray). Refer to chart below for more information.
- Choose from a wide range of available accessories and caster options (page 190) to customize table for a specific application.



LTM60XUPG3  
(Shown with accessories, casters and Starsys Cart)

Countertop Application Matrix							
Use Area	Epoxy Resin	Phenolic Resin	Stainless Steel	Characteristics	Epoxy Resin	Phenolic Resin	Stainless Steel
	2			Heat Resistance	Excellent	Fair*	Excellent
Low chemical use				Abrasion Resistance	Good	Excellent	Good
Moderate chemical use	X	X		Impact Resistance	Good	Excellent	Good
High chemical use		X	X	Strength	Good	Excellent	Good
				Stain Resistance	Good	Good	Good

\*Discolors with high heat  
Note: Phenolic resin and stainless are offered as top options for this table system. Epoxy resin information is shown for comparison only.

Definitions:

**Phenolic resin:** Compression molded of organic fiber-reinforced phenolic core with an integrally cured thermoset resin surface. Stronger than Epoxy resin over a span, and not as brittle.

**Stainless Steel:** Worksurfaces are fabricated from Type 304 stainless steel which provides excellent protection in corrosive environments.

**Epoxy resin:** Epoxy resins, silica, organic fillers, and inert hardeners are cast in forms and cured to a uniform mixture throughout.

Select Table Style from Chart Below and Following Page:

Worktables with Stainless Top and Backsplash with a Solid MetroMax i Shelf

Width (in.) (mm)	Length (in.) (mm)	Work Surface Height (in.) (mm)	Overall Height (in.) (mm)	Approx. Pkd. Wt. (lbs.) (kg)	Cat. No. Stationary	Cat. No. Mobile*
30	762	29 <sup>3</sup> / <sub>4</sub> 749	35 <sup>1</sup> / <sub>2</sub> 902	39 <sup>1</sup> / <sub>2</sub> 1003	65 29	LT30XS3 LTM30XS3
30	762	35 <sup>3</sup> / <sub>4</sub> 908	35 <sup>1</sup> / <sub>2</sub> 902	39 <sup>1</sup> / <sub>2</sub> 1003	70 32	LT36XS3 LTM36XS3
30	762	47 <sup>3</sup> / <sub>4</sub> 1213	35 <sup>1</sup> / <sub>2</sub> 902	39 <sup>1</sup> / <sub>2</sub> 1003	90 41	LT48XS3 LTM48XS3
30	762	59 <sup>3</sup> / <sub>4</sub> 1517	35 <sup>1</sup> / <sub>2</sub> 902	39 <sup>1</sup> / <sub>2</sub> 1003	100 45	LT60XS3 LTM60XS3

\*Casters ordered separately. Refer to Caster Selection Guide below for more information. Lab Worktables are load rated at 50 lbs. per sq. foot (.024kg per sq. cm) up to a maximum of 600 lbs. (273kg) assuming evenly distributed load and caster specification meets requirement.  
**Note:** Mobile posts include an adaptor insert that will accept Metro 5" (127mm) stem casters.

Worktables with Stainless Top and Backsplash with a 3-Sided Frame

Width (in.) (mm)	Length (in.) (mm)	Work Surface Height (in.) (mm)	Overall Height (in.) (mm)	Approx. Pkd. Wt. (lbs.) (kg)	Cat. No. Stationary	Cat. No. Mobile*
30	762	29 <sup>3</sup> / <sub>4</sub> 749	35 <sup>1</sup> / <sub>2</sub> 902	39 <sup>1</sup> / <sub>2</sub> 1003	65 29	LT30XUS3 LTM30XUS3
30	762	35 <sup>3</sup> / <sub>4</sub> 908	35 <sup>1</sup> / <sub>2</sub> 902	39 <sup>1</sup> / <sub>2</sub> 1003	75 34	LT36XUS3 LTM36XUS3
30	762	47 <sup>3</sup> / <sub>4</sub> 1213	35 <sup>1</sup> / <sub>2</sub> 902	39 <sup>1</sup> / <sub>2</sub> 1003	95 43	LT48XUS3 LTM48XUS3
30	762	59 <sup>3</sup> / <sub>4</sub> 1517	35 <sup>1</sup> / <sub>2</sub> 902	39 <sup>1</sup> / <sub>2</sub> 1003	110 50	LT60XUS3 LTM60XUS3

\*Casters ordered separately. Refer to Caster Selection Guide below for more information. Lab Worktables are load rated at 50 lbs. per sq. foot (.024kg per sq. cm) up to a maximum of 600 lbs. (273kg) assuming evenly distributed load and caster specification meets requirement.  
**Note:** Mobile posts include an adaptor insert that will accept Metro 5" (127mm) stem casters.



LTM30XS3  
(Featuring solid MetroMax i shelf shown with casters)



LTM30XUS3  
(Shown with accessory wire shelf and casters)

MetroMax i Lab Worktables — 52.01

Select Table Style from Chart Below:

Worktables with Black Phenolic Top and Solid MetroMax i Shelf



LTM60XPB3  
(Shown with backplash,  
accessories and casters)

Width (in.) (mm)	Length (in.) (mm)	Work Surface Height (in.) (mm)	Overall Height (in.) (mm)	Approx. Pkd. Wt. (lbs.) (kg)	Cat. No. Stationary	Cat. No. Mobile*
30 762	29 <sup>3</sup> / <sub>4</sub> 749	36 <sup>1</sup> / <sub>2</sub> 927	40 <sup>1</sup> / <sub>2</sub> 1016	85 38	LT30XPB3	LTM30XPB3
30 762	35 <sup>3</sup> / <sub>4</sub> 908	36 <sup>1</sup> / <sub>2</sub> 927	40 <sup>1</sup> / <sub>2</sub> 1016	91 41	LT36XPB3	LTM36XPB3
30 762	47 <sup>3</sup> / <sub>4</sub> 1213	36 <sup>1</sup> / <sub>2</sub> 927	40 <sup>1</sup> / <sub>2</sub> 1016	118 53	LT48XPB3	LTM48XPB3
30 762	59 <sup>3</sup> / <sub>4</sub> 1517	36 <sup>1</sup> / <sub>2</sub> 927	40 <sup>1</sup> / <sub>2</sub> 1016	138 62	LT60XPB3	LTM60XPB3

\*Casters ordered separately. Refer to Caster Selection Guide below for more information.  
Lab Worktables are load rated at 50 lbs. per sq. foot (.024kg per sq. cm) up to a maximum of 600 lbs. (273kg) assuming evenly distributed load and caster specification meets requirement.  
**Note:** Mobile posts include an adaptor insert that will accept Metro 5" (127mm) stem casters.

Worktables with Black Phenolic Top and 3-Sided Frame



LTM60XUPB3  
(Shown with accessories and casters)

Width (in.) (mm)	Length (in.) (mm)	Work Surface Height (in.) (mm)	Overall Height (in.) (mm)	Approx. Pkd. Wt. (lbs.) (kg)	Cat. No. Stationary	Cat. No. Mobile*
30 762	29 <sup>3</sup> / <sub>4</sub> 749	36 <sup>1</sup> / <sub>2</sub> 927	40 <sup>1</sup> / <sub>2</sub> 1016	90 41	LT30XUPB3	LTM30XUPB3
30 762	35 <sup>3</sup> / <sub>4</sub> 908	36 <sup>1</sup> / <sub>2</sub> 927	40 <sup>1</sup> / <sub>2</sub> 1016	97 44	LT36XUPB3	LTM36XUPB3
30 762	47 <sup>3</sup> / <sub>4</sub> 1213	36 <sup>1</sup> / <sub>2</sub> 927	40 <sup>1</sup> / <sub>2</sub> 1016	125 56	LT48XUPB3	LTM48XUPB3
30 762	59 <sup>3</sup> / <sub>4</sub> 1517	36 <sup>1</sup> / <sub>2</sub> 927	40 <sup>1</sup> / <sub>2</sub> 1016	145 66	LT60XUPB3	LTM60XUPB3

\*Casters ordered separately. Refer to Caster Selection Guide below for more information.  
Lab Worktables are load rated at 50 lbs. per sq. foot (.024kg per sq. cm) up to a maximum of 600 lbs. (273kg) assuming evenly distributed load and caster specification meets requirement.  
**Note:** Mobile posts include an adaptor insert that will accept Metro 5" (127mm) stem casters.

Worktables with Gray Phenolic Top and Solid MetroMax i Shelf



LTM60XPG3  
(Shown with backplash,  
accessories and casters)

Width (in.) (mm)	Length (in.) (mm)	Work Surface Height (in.) (mm)	Overall Height (in.) (mm)	Approx. Pkd. Wt. (lbs.) (kg)	Cat. No. Stationary	Cat. No. Mobile*
30 762	29 <sup>3</sup> / <sub>4</sub> 749	36 <sup>1</sup> / <sub>2</sub> 927	40 <sup>1</sup> / <sub>2</sub> 1016	85 38	LT30XPG3	LTM30XPG3
30 762	35 <sup>3</sup> / <sub>4</sub> 908	36 <sup>1</sup> / <sub>2</sub> 927	40 <sup>1</sup> / <sub>2</sub> 1016	91 41	LT36XPG3	LTM36XPG3
30 762	47 <sup>3</sup> / <sub>4</sub> 1213	36 <sup>1</sup> / <sub>2</sub> 927	40 <sup>1</sup> / <sub>2</sub> 1016	118 53	LT48XPG3	LTM48XPG3
30 762	59 <sup>3</sup> / <sub>4</sub> 1517	36 <sup>1</sup> / <sub>2</sub> 927	40 <sup>1</sup> / <sub>2</sub> 1016	138 62	LT60XPG3	LTM60XPG3

\*Casters ordered separately. Refer to Caster Selection Guide below for more information.  
Lab Worktables are load rated at 50 lbs. per sq. foot (.024kg per sq. cm) up to a maximum of 600 lbs. (273kg) assuming evenly distributed load and caster specification meets requirement.  
**Note:** Mobile posts include an adaptor insert that will accept Metro 5" (127mm) stem casters.

Worktables with Gray Phenolic Top and 3-Sided Frame



LTM60XUPG3  
(Shown with accessories and casters)

Width (in.) (mm)	Length (in.) (mm)	Work Surface Height (in.) (mm)	Overall Height (in.) (mm)	Approx. Pkd. Wt. (lbs.) (kg)	Cat. No. Stationary	Cat. No. Mobile*
30 762	29 <sup>3</sup> / <sub>4</sub> 749	36 <sup>1</sup> / <sub>2</sub> 927	40 <sup>1</sup> / <sub>2</sub> 1016	90 41	LT30XUPG3	LTM30XUPG3
30 762	35 <sup>3</sup> / <sub>4</sub> 908	36 <sup>1</sup> / <sub>2</sub> 927	40 <sup>1</sup> / <sub>2</sub> 1016	97 44	LT36XUPG3	LTM36XUPG3
30 762	47 <sup>3</sup> / <sub>4</sub> 1213	36 <sup>1</sup> / <sub>2</sub> 927	40 <sup>1</sup> / <sub>2</sub> 1016	125 56	LT48XUPG3	LTM48XUPG3
30 762	59 <sup>3</sup> / <sub>4</sub> 1517	36 <sup>1</sup> / <sub>2</sub> 927	40 <sup>1</sup> / <sub>2</sub> 1016	145 66	LT60XUPG3	LTM60XUPG3

\*Casters ordered separately. Refer to Caster Selection Guide below for more information.  
Lab Worktables are load rated at 50 lbs. per sq. foot (.024kg per sq. cm) up to a maximum of 600 lbs. (273kg) assuming evenly distributed load and caster specification meets requirement.  
**Note:** Mobile posts include an adaptor insert that will accept Metro 5" (127mm) stem casters.

For MetroMax i Mobile Worktables, Select Appropriate Casters from Chart Below.  
(Four brake casters are recommended for maximum table stability)

Caster Selection Guide

* Caster Series	Wheel Material	Rollability	Floor Protection	Noise	Load Rating (lbs.) (kg)	Corrosion Resistance	Cart Washable	Antimicrobial Additive in Wheel
5MDXA/5MDBXA (brake)	High Modulus Rubber	Good	Good	Low	250 114	Low	No	No
5MPX/5MPBX (brake)	Polyurethane	Good	Good	Moderate	300 137	Low	No	No
5PCX/5PCBX (brake)	Polyurethane	Good	Good	Moderate	300 137	High	No	No
5PCXM/5PCBXM (brake)	Polyurethane	Good	Good	Moderate	300 137	High	No	Yes
5MPXGSA/5MPXGSA (brake)	Polyurethane	Good	Good	Moderate	300 137	High	Yes	No

NOTE: The total weight of the equipment and its load should not exceed three times the load rating per caster.  
Additional stem casters, in various sizes and wheel materials, are available. Contact your Metro rep for more information.



5MDXA



5MPX



5PCBX



5PCBXM



5MPXGSA

**Note:** Use heavy-duty mobile post adapter (Cat. No. 9974HDP-4) to convert HD stationary post to accept any standard Metro 5" (127mm) series casters (shown above).

MetroMax i Lab Worktable Accessories — 52.01

**Backsplash**

4" (102mm) high. Attaches to phenolic table top (page 187), using pre-drilled holes. Match length and color with selected countertop.

Length (in.)	Length (mm)	Approx. Pkd. Wt. (lbs.)	Approx. Pkd. Wt. (kg)	Cat. No. Black	Cat. No. Gray
27 <sup>3</sup> / <sub>4</sub>	705	5.5	2.5	<b>LT30BSB</b>	<b>LT30BSG</b>
33 <sup>3</sup> / <sub>4</sub>	875	6.5	2.9	<b>LT36BSB</b>	<b>LT36BSG</b>
45 <sup>3</sup> / <sub>4</sub>	1162	7.5	3.4	<b>LT48BSB</b>	<b>LT48BSG</b>
57 <sup>3</sup> / <sub>4</sub>	1466	9.5	4.3	<b>LT60BSB</b>	<b>LT60BSG</b>



L30BSG

**Keyboard Tray**

Fits 48" and 60" (1219 and 1524mm) table lengths.

Cat. No. **LTKB**

Note: Keyboard tray and drawer will both fit a 60" (1524mm) table.



**Drawers**

Fit 30", 36", 48" and 60" (760, 914, 1219 and 1524mm) table lengths.

3" (76mm) Cat. No. **LTD3**

6" (152mm) Cat. No. **LTD6**

3" (76mm) locking Cat. No. **LTD3L**

6" (152mm) locking Cat. No. **LTD6L**

Note: Keyboard tray and drawer will both fit a 60" (1524mm) table.



**Wire Shelf**

Stainless or Epoxy-coated shelves available.

Length (in.)	Length (mm)	Approx. Pkd. Wt. (lbs.)	Approx. Pkd. Wt. (kg)	Cat. No. Stainless	Cat. No. Epoxy Coated
22 <sup>3</sup> / <sub>8</sub>	568	6	2.7	<b>LT30WS</b>	<b>LT30WE</b>
28 <sup>3</sup> / <sub>8</sub>	720	7.5	3.4	<b>LT36WS</b>	<b>LT36WE</b>
40 <sup>3</sup> / <sub>8</sub>	1025	10	4.5	<b>LT48WS</b>	<b>LT48WE</b>
52 <sup>3</sup> / <sub>8</sub>	1330	12	5.4	<b>LT60WS</b>	<b>LT60WE</b>

**Note:** Shelves are load rated for a maximum of 150 lbs. (68kg).



**Surface Mount Swing Arm for Flat Monitor**

Cat. No. **LTFMA**

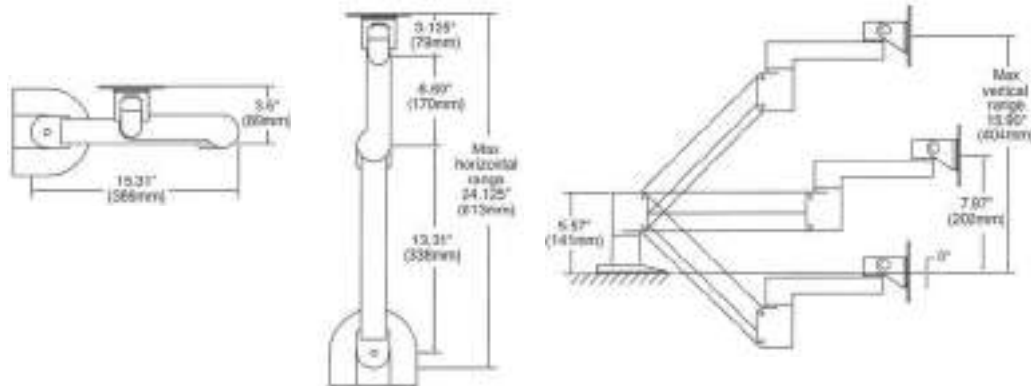

LTFMA

## Worktables — 17.20

Built for cleanliness and stability.

- Seamless 14-gauge Type 304 stainless steel work surface and support structure.
- Shipped knocked down and can be assembled in minutes without tools.

All Worktables are 34" (864mm) high with stationary posts and leveling feet.

### Standard Worktables — 30" (760mm) Wide



Worktable with Bottom Shelf

Length (in.) (mm)	Post Material	Bottom Shelf Material	Bottom 3-Sided Frame Material	Bottom H-Frame Material	Approx. Pkd. Wt. (lbs.) (kg)	Cat. No.
48 1219	SS	SS	—	—	90 41	<b>WT305FS</b>
60 1524	SS	SS	—	—	130 59	<b>WT306FS</b>
72 1825	SS	SS	—	—	170 77	<b>WT307FS</b>
96 2439	SS	SS	—	—	226 103	<b>WT309FS</b>
60 1524	Chrome	Galvanized	—	—	146 66	<b>WT306FC</b>
72 1825	Chrome	Galvanized	—	—	180 82	<b>WT307FC</b>
96 2439	Chrome	Galvanized	—	—	226 103	<b>WT309FC</b>
48 1219	SS	—	SS	—	115 52	<b>WT305US</b>
60 1524	SS	—	SS	—	115 52	<b>WT306US</b>
72 1825	SS	—	SS	—	142 65	<b>WT307US</b>
96 2439	SS	—	SS	—	201 91	<b>WT309US</b>
60 1524	SS	—	—	SS	115 52	<b>WT306HS</b>
72 1825	SS	—	—	SS	142 65	<b>WT307HS</b>
96 2439	SS	—	—	SS	202 92	<b>WT309HS</b>

SS = Stainless Steel

### Standard Worktables — 36" (914mm) Wide



Worktable with 3-Sided Frame

Length (in.) (mm)	Post Material	Bottom Shelf Material	Bottom 3-Sided Frame Material	Bottom H-Frame Material	Approx. Pkd. Wt. (lbs.) (kg)	Cat. No.
60 1524	SS	SS	—	—	125 57	<b>WT366FS</b>
72 1825	SS	SS	—	—	130 59	<b>WT367FS</b>
96 2439	SS	SS	—	—	185 84	<b>WT369FS</b>
60 1524	Chrome	Galvanized	—	—	125 57	<b>WT366FC</b>
72 1825	Chrome	Galvanized	—	—	130 59	<b>WT367FC</b>
96 2439	Chrome	Galvanized	—	—	185 84	<b>WT369FC</b>
60 1524	SS	—	SS	—	104 47	<b>WT366US</b>
72 1825	SS	—	SS	—	106 48	<b>WT367US</b>
96 2439	SS	—	SS	—	161 73	<b>WT369US</b>
60 1524	SS	—	—	SS	103 47	<b>WT366HS</b>
72 1825	SS	—	—	SS	107 49	<b>WT367HS</b>
96 2439	SS	—	—	SS	162 74	<b>WT369HS</b>

SS = Stainless Steel

### Standard Worktables — 44" (1118mm) Wide



Worktable with H-Frame

Length (in.) (mm)	Post Material	Bottom Shelf Material	Bottom 3-Sided Frame Material	Bottom H-Frame Material	Approx. Pkd. Wt. (lbs.) (kg)	Cat. No.
60 1524	SS	SS	—	—	136 62	<b>WT446FS</b>
72 1825	SS	SS	—	—	160 73	<b>WT447FS</b>
96 2439	SS	SS	—	—	202 92	<b>WT449FS</b>
60 1524	Chrome	Galvanized	—	—	136 62	<b>WT446FC</b>
72 1825	Chrome	Galvanized	—	—	160 73	<b>WT447FC</b>
96 2439	Chrome	Galvanized	—	—	202 92	<b>WT449FC</b>
60 1524	SS	—	SS	—	114 52	<b>WT446US</b>
72 1825	SS	—	SS	—	135 61	<b>WT447US</b>
96 2439	SS	—	SS	—	177 81	<b>WT449US</b>
60 1524	SS	—	—	SS	113 51	<b>WT446HS</b>
72 1825	SS	—	—	SS	136 62	<b>WT447HS</b>
96 2439	SS	—	—	SS	178 81	<b>WT449HS</b>

SS = Stainless Steel



## Mobile Worktables — 17.20

All Mobile Worktables are 34" (864mm) high. Mobile units have special posts and four 5" (127mm) poly casters — 2 swivel/2 brake.

### Mobile Worktables — 30" (760mm) Wide

Length (in.)	Length (mm)	Post Material	Bottom Shelf Material	Bottom 3-Sided Frame Material	Bottom H-Frame Material	Approx. Pkd. Wt. (lbs.) (kg)		Cat. No.
48	1219	SS	SS	—	—	105	48	MWT305FS
60	1524	SS	SS	—	—	160	73	MWT306FS
72	1825	SS	SS	—	—	182	83	MWT307FS
96	2439	SS	SS	—	—	226	103	MWT309FS
60	1524	Chrome	Galvanized	—	—	146	66	MWT306FC
72	1825	Chrome	Galvanized	—	—	180	82	MWT307FC
96	2439	Chrome	Galvanized	—	—	226	103	MWT309FC
48	1219	SS	—	SS	—	130	59	MWT305US
60	1524	SS	—	SS	—	139	63	MWT306US
72	1825	SS	—	SS	—	155	71	MWT307US
96	2439	SS	—	SS	—	201	91	MWT309US
60	1524	SS	—	—	SS	124	56	MWT306HS
72	1825	SS	—	—	SS	156	71	MWT307HS
96	2439	SS	—	—	SS	202	92	MWT309HS

SS = Stainless Steel



Mobile Worktable

## Worktables with Overhead — 17.26

All Worktables with Overhead are 30" (760mm) wide and have rear posts that are approximately 88" (2235mm) high. Cantilever shelves for overhead models are sold separately (see page 194).

Length (in.)	Length (mm)	Post Material	Bottom Shelf Material	Bottom 3-Sided Frame Material	Approx. Pkd. Wt. (lbs.) (kg)		Cat. No.
60	1524	SS	SS	—	158	71	WTC306FS
72	1825	SS	SS	—	251	114	WTC307FS
96	2440	SS	SS	—	288	131	WTC309FS
60	1524	Chrome	Galvanized	—	214	97	WTC306FC
72	1825	Chrome	Galvanized	—	251	114	WTC307FC
96	2440	Chrome	Galvanized	—	288	131	WTC309FC
60	1524	SS	—	SS	196	89	WTC306US
72	1825	SS	—	SS	230	105	WTC307US
96	2440	SS	—	SS	267	121	WTC309US

All overhead models are fitted with stationary posts and leveling feet.  
For overhead models in other sizes, contact your InterMetro representative.  
SS = Stainless Steel



Shown with optional Cantilever Shelf and Utility Rack



Cantilever Shelf — 10.67

Width/Length (in.) (mm)		Fits Unit	Approx. Pkd. Wt. (lbs.) (kg)		Cat. No. Chrome	Cat. No. Stainless
12x54	304x1372	60" (1524mm) long	11.8	5.3	1254CHC	1254CHS
12x60	304x1524	72" (1830mm) long & 96" (2440mm) long	12.7	5.7	1260CHC	1260CHS

Cantilever Shelf



3 1/2" (89mm) Foot Plate



Replacement HD Super™ Plastic Split Sleeve



Post Clamp



Replacement HD Super™ Aluminum Split Sleeve



Replacement 5 1/2" (140mm) Donut Bumper

HD Super™ Replacement Parts — 10.69

3 1/2" (89mm) Foot Plates

Cat. No. **9993HS**

Post Clamps

Cat. No. **9994HZ**

Replacement HD Super™ Plastic Split Sleeves

4 pair per bag

Cat. No. **9985H**

Replacement HD Super™ Aluminum Split Sleeves with Zinc Ring

4 pair per bag

Cat. No. **9986HZ**

Wall Mounting Brackets  
(not shown)

Cat. No. **9984HZ**

Replacement 5 1/2" (140mm) Donut Bumpers

Cat. No. **9992H**

Above fit 1 5/8" (41mm) posts only.

Accessories for Worktables with Overhead — 17.26

Utility Racks for Overhead Models

Inside dimensions measure 1 15/16" (48mm) high and 4 3/8" (109mm) wide.

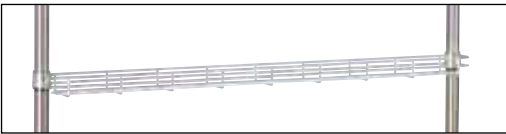

Utility Rack

Inside Length (in.) (mm)		Fits Units (in.)	Finish	Approx. Pkd. Wt. (lbs.) (kg)		Cat. No.
51 9/16	1406	60 long	Chrome-Plated	7.7	3.5	654SRC
57 9/16	1406	72 long & 96 long	Chrome-Plated	8.3	3.8	660SRC



Utility Hook

Utility Hook for Cantilever Shelves

Width/Height/Depth (in.) (mm)		Finish	Approx. Pkd. Wt. (lbs.) (kg)		Cat. No.
3/8x3 7/16x1 11/16	9x87x43	Chrome	0.1	.045	HK23C
3/8x3 7/16x1 11/16	9x87x43	Stainless	0.1	.045	HK23S

Accessories for All Worktables — 17.22

Economy Drawer

Overall Dimensions Width/Length/Height (in.) (mm)		Dimensions Inside Bottom (in.) (mm)		Approx. Pkd. Wt. (lbs.) (kg)		Cat. No.
14 1/4x28x5 3/4	362x711x146	10x16	254x406	6.8	3.1	WTD21C

Deluxe Drawer

Table accepts up to two drawers stacked.

Overall Dimensions Width/Length/Height (in.) (mm)		Dimensions Inside Bottom (in.) (mm)		Approx. Pkd. Wt. (lbs.) (kg)		Cat. No.
24x25 3/4x7 1/2	610x654x191	20x20	508x508	31	13.9	WTD51S



Deluxe Drawer

# METRO TECH SERIES™ – MOBILE COMPUTING WORKCENTERS

METRO TECH SERIES™ is designed around you, and the way you work. It's the perfect way to modernize your data management while reducing collection errors.



**Technology** — Mobile Computing WorkCenters from Metro are designed to support all software platforms and a variety of hardware technologies. (Monitor and keyboard not included)

**Articulating Keyboard Tray** — Articulating (right to left) keyboard surface and ambidextrous mouse surface, provide for unobstructed access to storage drawers. (See below)

**“Battery Gauge”** — A top mounted LED gauge with audible alarm alerts operators when it is time to recharge the system.

**“One-Touch” Height Adjustability** — Push button height adjustability lowers or raises work surface from 31-41 inches.

**More Storage** — Single or multi-tier locking storage drawers are available.

**AC Power** — 4 receptacle outlet strip

**Power System** — Rapid rechargeable batteries convert to true sine wave AC output.

Shown CPU model holding standard monitor and keyboard. (Monitor & keyboard not included)



Shown laptop model with articulating arm and secure laptop tray. (Laptop not included)

## CPU Style

Configuration	Width/Depth	Width/Depth	Cat. No.
CPU, 1 Drawer	21" x 21"	22" x 21"	T7C
CPU, 2 Drawers	21" x 21"	22" x 21"	T8C

Pre-configured “CPU” units consist of a 16" monitor mounting arm with Vesa plate adapter, articulating keyboard tray with ambidextrous mouse tray, 52 Amp hour power system, computer mounting bracket with security cover, (4) 5" Casters (2 with brake), Storage Drawer(s) (T7 has 1-3" drawer With keylock, T8 has 1-3" and 1-6" drawer with keylock).

## Laptop Style

Configuration	Worksurface Width/Depth	Unit Width/Depth	Cat. No.
Laptop, 1 Drawer	22" x 21"	22" x 21"	T7L
Laptop, 2 Drawers	22" x 21"	22" x 21"	T8L

Pre-configured “Laptop” units consist of a 8" multi-pivot arm with Vesa plate adapter, laptop security tray with ambidextrous mouse tray, 52 Amp hour power system, (4) 5" Casters (2 with brake), Storage Drawer(s) (T7 has 1-3" drawer with keylock, T8 has 1-3" and 1-6" drawer with keylock).

# Power on the move...

Where you need it, when you need it!

Not enough AC wall outlets in your facility, outlets not in the right locations or do you have safety concerns with extension cords strewn throughout your labs?

## Introducing Metro Power Spot™ Portable Power Module



**UP TO 8 HOURS OF AC POWER**

Integrated premium power system provides 150 watts of AC power.

**CORROSION-RESISTANT TYPE 304 STAINLESS STEEL EXTERIOR**

Provides a lifetime of performance.



**TRUE SINE WAVE POWER**

Premium power inverter produces clean AC power to optimize electronic equipment performance.

**AUDIBLE ALARM**

Alerts you to low battery condition.

**BATTERY GAUGE**

Easy to view indicator light. Rapid rechargeable batteries take 4-6 hours to recharge.

Perfect for

- Environmental Monitoring
- Validation
- Metrology (Calibration)
- Lab Animal Census/Data Collection
- Mobile Computing and Label Printing

Power Spot Portable Power Module

Depth (in.)	Length (mm)	Height (mm)	Weight (with batteries installed)		Cat. No.
			(lbs.)	(kg)	
17x9x13 <sup>3</sup> / <sub>4</sub>	432	229x349	85	38.5	PS150S

# Mobile Power Units

Preconfigured Metro Carts support a wide range of applications that require a portable power solution. Preconfigured carts come complete with Metro's Power Spot Portable Power Module.

**6-8 Hours of AC Power** — Integrated premium power system provides 150 watts of AC power accessed via a built-in 4 outlet power strip.

**True Sine Wave Power** — Premium power inverter produces clean AC power optimizing electronic equipment performance.

**Corrosion Resistant** — Mobile Power Units (MetroMax i and Super Erecta Stainless) are constructed from advanced polymers and Type 304 Stainless Steel providing a lifetime of performance.

**Maneuverable** — Mobile Power Units feature a small footprint to maximize maneuverability. Available in 18" x 30" (457 x 762mm), 18" x 36" (457 x 914mm), 24" x 30" (610 x 762mm) and 24" x 36" (610 x 914mm). Other sizes and configurations available.

**Storage** — Mobile Power Units have ample room for manuals, peripherals and other necessary items.

## MetroMax i\*

WidthxLength	Cat. No.
18 x 30	<b>MPU-MX1830F</b>
18 x 36	<b>MPU-MX1836F</b>
24 x 30	<b>MPU-MX2430F</b>
24 x 36	<b>MPU-MX2436F</b>

## Super Erecta Stainless Steel\*

WidthxLength	Cat. No.
18 x 30	<b>MPU-1830NFS</b>
18 x 36	<b>MPU-1836NFS</b>
24 x 30	<b>MPU-2430NFS</b>
24 x 36	<b>MPU-2436NFS</b>

## Super Erecta® Stainless Steel with PowerSpot



## MetroMax i® with PowerSpot



Units Shown with Optional Accessories (see optional accessories below)

**\*PRE-CONFIGURED UNITS** — Pre-configured units consist of (3) Super Erecta stainless steel solid shelves or (2) MetroMax i polymer solid shelves and a Phenolic worksurface, (2) 33" (838mm) posts, (2) 54" (1372mm) posts, (1) flat panel monitor mounting rail, (4) casters (2 with brake), (1) stainless steel handle, wire management ties and (1) PowerSpot Mobile Power System.

## Accessories



Keyboard Tray (Stainless Steel)  
Cat. No. **KBSS**



Sharps Container\*  
Cat. No. **FL250**



Wire Basket\*  
Cat. No. **H210C**



Waste Basket\*  
Cat. No. **FL221**



Monitor Mounting Bracket  
Cat. No. **FPMB**

Bracket\*  
Cat. No. **FL251**

\*Requires side accessory rail.



Side Accessory Rail  
Shown holding wire basket (above).

Description	Cat. No. MetroMax i	Cat. No. Super Erecta
Fits 18" (457mm) wide unit	<b>SAR18X3</b>	<b>SAR18S</b>
Fits 24" (610mm) wide unit	<b>SAR24X3</b>	<b>SAR24S</b>

Wire Management Straps (not shown)  
Bag of 10 pieces.

Cat. No. **WMGT10**

# Solutions That Move You. Mobile, Modular System . . . Flexible Space

NOW with Microban® antimicrobial product protection inhibiting the growth of mold, mildew, and bacteria.

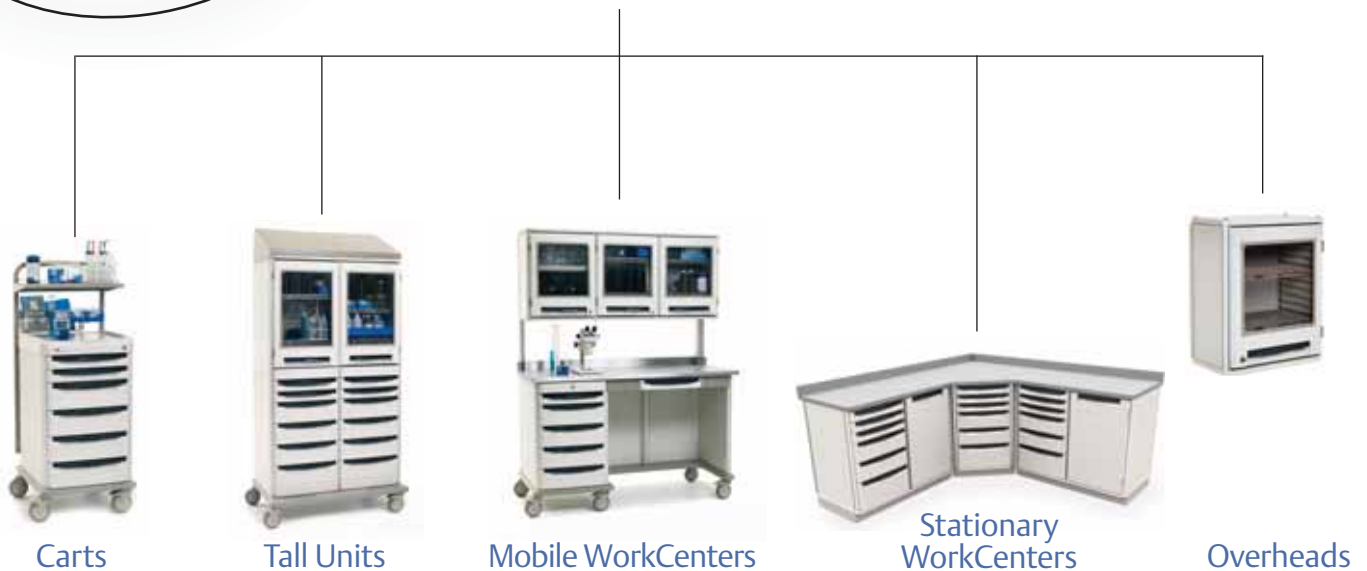

## The Starsys Mobile, Modular System creates flexible space.

No matter what you need — open, closed, short, tall, mobile, stationary elements, preconfigured WorkCenters or carts . . . Starsys has the elements for you.

With Starsys, you choose from an array of modular units to fit the space and work specifications. It's that easy and that flexible.

## Starsys Benefits:

- Facilitates fast, efficient product installation.
- The ability to easily reconfigure lab furniture layout as needs change.
- The ability to quickly reconfigure unit design.
- Flexibility to design a storage solution to meet your exact needs.
- Microban®\* antimicrobial product protection inhibits the growth of mold, mildew, and bacteria keeping the surface area “cleaner between cleanings.”
- Durable, easy-to-clean, polymer enclosures that won't chip, peel, dent or rust ever.
- Rigid aluminum substructure combined with advanced polymers provides a robust stable work environment for even the most sensitive equipment.
- A high level of organization with easy access to supplies.
- Greater storage density in a smaller footprint.

\*MICROBAN® and the MICROBAN® symbol are registered trademarks of the Microban Products Company, Huntersville, NC.

Starsys Carts are built to exact customer specifications, therefore, they are non-cancelable, non-returnable.  
For Starsys pricing information, please contact your local Metro representative.

# Metro® Starsys™ — Reinvent Your Lab!

The mobile, modular Starsys Lab System creates flexible space enhancing lab productivity and space efficiency by empowering you with the ability to easily reconfigure your lab space.



Research Lab . . .

Research Lab, 5 minutes Later . . .

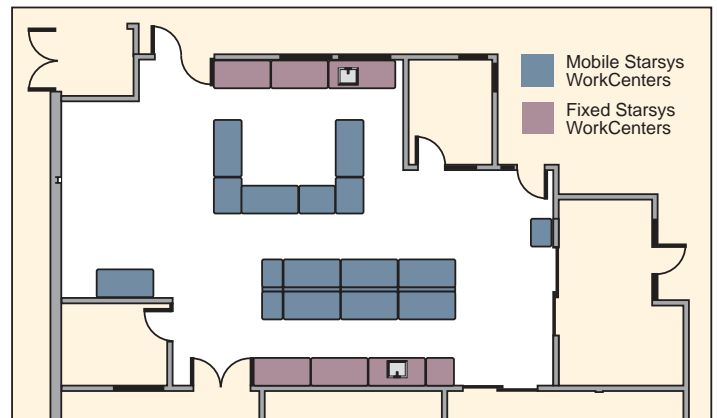
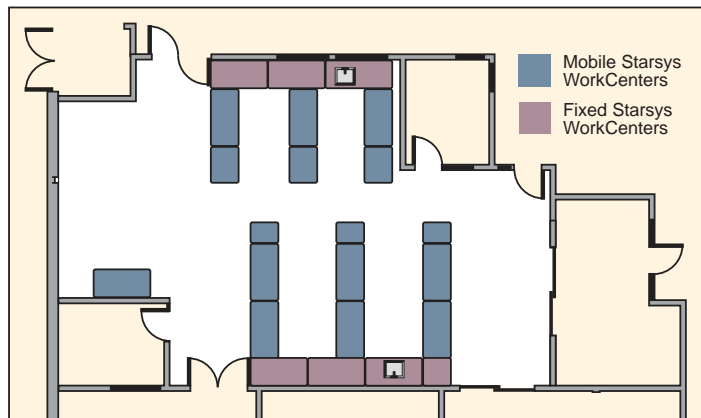

Note: The Starsys System features advanced polymer materials that offer excellent chemical resistance. To obtain a complete Starsys chemical resistance report, please contact your local Metro representative.

To configure a Starsys unit to your exact specifications, please visit [www.metroconfigurator.com](http://www.metroconfigurator.com)

# Solutions That Move You. Mobile, Modular, Metro.



Microban® antimicrobial protection inhibits the growth of stain and odor-causing bacteria on Starsys, keeping the surface areas “cleaner between cleanings.”

Easy to clean advanced polymer material is a marked improvement over traditional metal carts: won't dent, chip, rust, flake or corrode.

Interchangeable 3", 6" and 9" (76, 152 and 230mm) drawers with removable totes can be fully extended for easy access.

Color-coded drawer pulls are available in an array of choices to fit any system or decor.

Label holders available to quickly identify drawer contents.

Each drawer face has a 1/2 x 18 3/8" polished area allowing for secure adhesion of DYMO and Zebra labels (not supplied by Metro).



The convenient overbridge can be fitted with a wide selection of baskets, shelves, and bins to keep necessary items within reach.

Swing-out Side Storage units increase work surface up to 135%.

Side storage allows easy customization of a wide variety of accessories.

5" (127mm) polymer total-lock casters provide a stable work station when locked and smooth rolling cart when not.



## Starsys Carts

Starsys provides a complete system of enclosed carts in a wide variety of heights and system widths. When mobility is a key part of your storage needs, Starsys carts provide a broad selection of unique solutions. This modular system approach allows you to create a cart to meet your exact needs.

### Starsys cart widths and depths:

The Starsys cart system is built upon a square module. Multiplying this storage module results in system widths of single 22 3/4" (578mm), double 42 1/2" (1080mm) and triple widths 62 1/2" (1588mm). Depth on all carts is 24.9" (632mm).

### Starsys cart heights:

Starsys carts are available in the following working heights: 36" (907mm), 39" (983mm), 42" (1060mm), 45" (1136mm) and 48" (1212mm).

## General Overview:

Starsys carts feature 5" (127mm) polymer swivel casters. The front two casters have a total-lock toe brake (locks both the wheel and the horn).

Starsys carts feature a smooth polymer top/worksurface. If chemical resistance is a concern or heavy equipment is likely to be placed on the top of the cart, Starsys Mobile WorkCenters may be a more appropriate product selection.

An extended mobile base is required when Heavy-Duty drawers, Active Level shelving or quikSLOT shelving is specified in a Starsys configuration. The extended mobile base adds an additional 3" (76mm) to the overall depth of the cart. The extended base combines additional counter weights with a deeper footprint to reduce any chance of overbalance when active level shelving is fully extended.

Starsys Carts are built to exact customer specifications, therefore, they are non-cancelable, non-returnable.

For Starsys pricing information, please contact your local Metro representative.



See page 200 for specification details.

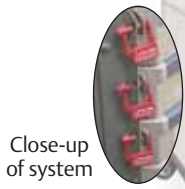

Close-up of system



Emergency Response  
Cat. No. **SXR540CM1**



General Supply  
Cat. No. **SXR5150**



Gowning Storage  
Cat. No. **SXR5MDSRG**



Fume Hood Storage  
Cat. No. **SXR5DR5**



Personal Protective Equipment  
Cat. No. **SXR543CM1**



Validation  
Cat. No. **SXR543CM3**



General Supply  
Cat. No. **SXR543CM4**



General Supply  
Cat. No. **SXR543CM6**



LAR Surgery  
Cat. No. **SXR5SANES**



Computer  
Cat. No. **SXR5BED**



LAR Investigator  
Cat. No. **SXR5DCMED**



LAR Procedure  
Cat. No. **SXR5ARTH**



Computer Ready Cart  
Cat. No. **SXR5COMPBED**



LAR I.V. Therapy  
Cat. No. **SXR5SIV**

To configure a Starsys unit to your exact specifications, please visit [www.metroconfigurator.com](http://www.metroconfigurator.com)

See page 200 for specification details.



LAR Anesthesia  
Cat. No. **SXRSUDOSE**



LAR Imaging  
Cat. No. **SXRSTRAMA**



Cold Room/Buffer Cart  
Cat. No. **SXRD43CM3**



LAR Secure Transport  
Cat. No. **SXRD43CM4**



Biomedical  
Cat. No. **SXRSBIO**



LAR Euthanize  
Cat. No. **SXRSCCU**



LAR Procedure  
Cat. No. **SXRSCAST**



SXR53310L



SXR53210L

Basic Single Wide, Locking Carts

(in.)	(mm)	Drawer Configuration	Cat. No.
24 <sup>7</sup> / <sub>8</sub> x22 <sup>3</sup> / <sub>4</sub> x41 <sup>3</sup> / <sub>4</sub>	1061x578x1061	1-3", 3-6", 1-9", 0-12"	<b>SXRS1310L</b>
24 <sup>7</sup> / <sub>8</sub> x22 <sup>3</sup> / <sub>4</sub> x41 <sup>3</sup> / <sub>4</sub>	1061x578x1061	3-3", 2-6", 1-9", 0-12"	<b>SXRS3210L</b>
24 <sup>7</sup> / <sub>8</sub> x22 <sup>3</sup> / <sub>4</sub> x41 <sup>3</sup> / <sub>4</sub>	1061x578x1061	5-3", 1-6", 1-9", 0-12"	<b>SXRS5110L</b>
24 <sup>7</sup> / <sub>8</sub> x22 <sup>3</sup> / <sub>4</sub> x44 <sup>3</sup> / <sub>4</sub>	1137x578x1137	1-3", 2-6", 2-9", 0-12"	<b>SXRS1220L</b>
24 <sup>7</sup> / <sub>8</sub> x22 <sup>3</sup> / <sub>4</sub> x44 <sup>3</sup> / <sub>4</sub>	1137x578x1137	4-3", 2-6", 1-9", 0-12"	<b>SXRS4210L</b>
24 <sup>7</sup> / <sub>8</sub> x22 <sup>3</sup> / <sub>4</sub> x44 <sup>3</sup> / <sub>4</sub>	1137x578x1137	6-3", 1-6", 1-9", 0-12"	<b>SXRS6110L</b>
24 <sup>7</sup> / <sub>8</sub> x22 <sup>3</sup> / <sub>4</sub> x47 <sup>3</sup> / <sub>4</sub>	1213x578x1213	0-3", 3-6", 2-9", 0-12"	<b>SXRS0320L</b>
24 <sup>7</sup> / <sub>8</sub> x22 <sup>3</sup> / <sub>4</sub> x47 <sup>3</sup> / <sub>4</sub>	1213x578x1213	2-3", 2-6", 2-9", 0-12"	<b>SXRS2220L</b>
24 <sup>7</sup> / <sub>8</sub> x22 <sup>3</sup> / <sub>4</sub> x47 <sup>3</sup> / <sub>4</sub>	1213x578x1213	3-3", 3-6", 1-9", 0-12"	<b>SXRS3310L</b>

Drawer Pulls (one required per drawer) To specify color for drawer pull, order following catalog numbers for each drawer:

Dark Taupe SXRDP-TP	White SXRDP-WH	Code Blue SXRDP-CB	Red SXRDP-RE	Orange SXRDP-OR	Green SXRDP-GR	Yellow SXRDP-YL	Slate Blue SXRDP-BL	Purple SXRDP-VL	Pink SXRDP-PK	Black SXRDP-BK

Starsys Carts are built to exact customer specifications, therefore, they are non-cancelable, non-returnable.

For Starsys pricing information, please contact your local Metro representative.

## Starsys Carts — Security Options

### Mechanical Keylocks

The new M300 Series Keylocks have an "Ignition-Style" design to protect keys from bending or breaking. Mechanical keylocks are a good choice for all kinds of applications and work on all types of units and accessories — carts, cabinets, drawers, doors and wall cabinets. They are available as primary locks or as backups for other types of locking systems. Each lock includes a set of two keys. Extra keys available upon request.



M300 Series Keylock



EPBL Lock

### Electronic Push Button Locks (“EPBL” Locks)

The “EPBL” Lock is a simple push-button, battery-operated 4-digit code lock with a 10-digit push button face and 10-user programmable PIN numbers. Correctly entering a 4-digit code will allow a simple lock latch to be turned for access. Master, Sub-Master, User and Single Use functions. Power: (2) AAA Batteries.

### Electronic Touchpad Locking System

Our most advanced full-feature keyless electronic drawer locking system designed for use on single-, double- and triple-wide carts in heights from 36" to 48" tall.

Features:

- 2,000 User/Supervisor Codes
- Auto-relock with Motion Sensors
- USB Port for Audit Access
- Proximity & Magnetic Card Reader Options
- User Management/Audit Trail Software option
- Multiple Bay Security



### Touchpads & Options

Description	Cat. No.
Keyless Entry Touchpad — Single Bay Locking	SXRTP-varies
Keyless Entry Touchpad — Double Bay Locking	SXRTP-varies
Keyless Entry Touchpad — Triple Bay Locking	SXRTP-111
User Management/Audit Trail Software	FL421
Charger/Voltage Adapter (for outside N. America)	SXR-INTLCHGR
Proximity Reader	SXR-PRXRDR
Proximity User Card	SXR-UPROXCRD
Proximity Key Ring Tag	SXR-PROXTAG
Magstripe Reader	SXR-MAGRDR

### Hinged Push-Button Lockbars

These versatile push button lockbars can be used to lock both drawers and doors. Because the push button mechanism is purely mechanical, no wiring, electronic or batteries are required. Each lockbar includes a backup M300 series keylock, 2 keys, and a passive security locktab (security seals ordered separately: LEC9900A = Bag of 100).

For Factory-Assembled Units

Description	Left Mounted Cat. No.	Right Mounted Cat. No.
24"H (610mm) Hinged Lockbar	SXRPBL24L	SXRPBL24R
27"H (686mm) Hinged Lockbar	SXRPBL27L	SXRPGL27R
30"H (762mm) Hinged Lockbar	SXRPBL30L	SXRPBL30R
33"H (839mm) Hinged Lockbar	SXRPBL33L	SXRPBL33R
36"H (914mm) Hinged Lockbar	SXRPBL36L	SXRPBL36R

For field retrofit of above key locking bars, add suffix **-KD** to above part numbers.



Tamper-Evident Locks



Hinged Lockbar

### Tamper-Evident (Passive Security) Locks

Provides passive security for each drawer individually. Quick visual confirmation of broken seals indicates which drawers have been opened. Includes factory-installed lockbar, drawer locktabs permanently riveted to each drawer, and 100 security seals.

To configure a Starsys unit to your exact specifications, please visit [www.metroconfigurator.com](http://www.metroconfigurator.com)



Removable drawer totes allow for exchange or convenient access outside of cart

Polymer Drawers (Drawer pull required — see selection below)

Description	Inside Dimensions (Height/Width/Length) (in.)	Non-Locking Cat. No.	Locking Cat. No.
3" (76mm) SW Drawer	2 <sup>3</sup> / <sub>8</sub> x16 <sup>3</sup> / <sub>8</sub> x15 <sup>7</sup> / <sub>8</sub>	<b>SXRS3</b>	<b>SXRS3-LK</b>
4.5" (114mm) SW Drawer	37/8x16 <sup>3</sup> / <sub>8</sub> x15 <sup>7</sup> / <sub>8</sub>	<b>SXRS4.5</b>	
6" (152mm) SW Drawer	5 <sup>3</sup> / <sub>8</sub> x16 <sup>1</sup> / <sub>4</sub> x15 <sup>3</sup> / <sub>4</sub>	<b>SXRS6</b>	<b>SXRS6-LK</b>
7.5" (191mm) SW Drawer	6 <sup>7</sup> / <sub>8</sub> x16 <sup>1</sup> / <sub>4</sub> x15 <sup>3</sup> / <sub>4</sub>	<b>SXRS7.5</b>	
9" (230mm) SW Drawer	8 <sup>3</sup> / <sub>8</sub> x16 <sup>1</sup> / <sub>4</sub> x15 <sup>3</sup> / <sub>4</sub>	<b>SXRS9</b>	<b>SXRS9-LK</b>
10.5" (267mm) SW Drawer	9 <sup>7</sup> / <sub>8</sub> x16 <sup>1</sup> / <sub>4</sub> x15 <sup>3</sup> / <sub>4</sub>	<b>SXRS10.5</b>	
12" (305mm) SW Drawer	11 <sup>3</sup> / <sub>8</sub> x16 <sup>1</sup> / <sub>4</sub> x15 <sup>3</sup> / <sub>4</sub>	<b>SXRS12</b>	

Drawer Pulls (one required per drawer) To specify color for drawer pull, order following catalog numbers for each drawer:

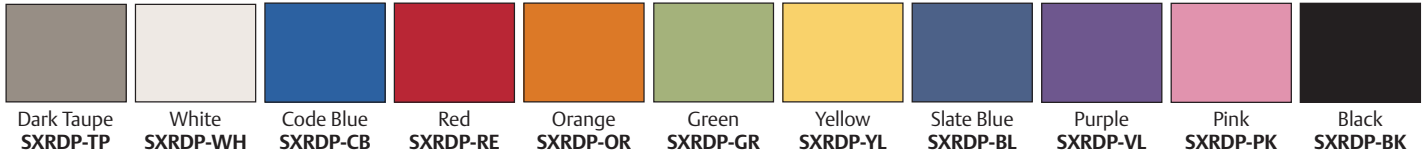

SXRLABKIT

Drawer Label Holders

Description	Height/Length in.	Cat. No.
Label Kits (10 Pieces Per Kit)	3/4" X 11" (19 x 279mm)	<b>SXRLABKIT</b>



Drawer dividers are available to organize your supplies for easy access.

Drawer Accessories for Drawers and Full Extension Totes

Drawer Divider Kits

Description	Product Detail (Qty.) in.	Cat. No.
3" (76mm) Drawer Divider Kit	(2) 16.8 & (6) 5	<b>SXR3DIV</b>
3" (76mm) Drawer Short Dividers	(3) 5	<b>SXR3SDIV</b>
3" (76mm) Drawer Long Dividers	(2) 16.8	<b>SXR3LDIV</b>
Egg Crate Style 3" (76mm) Drawer Divider Kit	(5) 16.8 & (10) 8	<b>SXR3DVR</b>
6" (76mm) Drawer Divider Kit	(2) 16.8 & (6) 5	<b>SXR6DIV</b>
6" (76mm) Drawer Short Dividers	(3) 5	<b>SXR6SDIV</b>
6" (76mm) Drawer Long Dividers	(2) 16.8	<b>SXR6LDIV</b>
Egg Crate Style 6"/9" (152/230mm) Drawer Divider Kit	(5) 16.8 & (10) 8	<b>SXR6DVR</b>



Drawer Totes

Additional Starsys Totes — Totes provide complete containment for smaller items.

Description	Inside Dimensions (Height/Width/Length) (in.) (mm)	Non-Locking Cat. No.	Locking Cat. No.
3" (76mm) Drawer Tote	2 <sup>3</sup> / <sub>4</sub> x18 <sup>1</sup> / <sub>4</sub> x17 <sup>1</sup> / <sub>2</sub> 70x464x445	<b>SXR3TOTE</b>	<b>SXR3-LKTOTE</b>
6" (152mm) Drawer Tote	5 <sup>3</sup> / <sub>4</sub> x18 <sup>1</sup> / <sub>4</sub> x17 <sup>1</sup> / <sub>2</sub> 146x464x445	<b>SXR6TOTE</b>	<b>SXR6-LKTOTE</b>
9" (229mm) Drawer Tote	8 <sup>1</sup> / <sub>2</sub> x18 <sup>1</sup> / <sub>4</sub> x17 <sup>1</sup> / <sub>2</sub> 216x464x445	<b>SXR9TOTE</b>	<b>SXR9-LKTOTE</b>

Starsys Carts are built to exact customer specifications, therefore, they are non-cancelable, non-returnable.

For Starsys pricing information, please contact your local Metro representative.

Accessories for Units with Slotted Polymer Inner Panels

Polymer Shelves

Cat. No.	Description
<b>SXRPOLY</b>	Single Wide Polymer Shelf
<b>SXRPOLYDIV</b>	Poly Shelf Divider Kit (Includes 2 Divider Rails, 4 Dividers)
<b>SXRSF-VSHFDIV</b>	Single Wide Vertical Shelf Divider Kit (w/(2) brackets & (2) vertical dividers)
<b>SXRDF-VSHFDIV</b>	Double Wide Vertical Shelf Divider Kit (w/(2) brackets & (2) vertical dividers)
<b>SXRFVDIV-1</b>	Extra Vertical Shelf Divider



Polymer shelves are easy to clean and reposition.

Suture Storage

Cat. No.	Description
<b>SXRSUTURE</b>	Suture Storage Module



Suture Storage

Full-Extension Totes/Dividers

Cat. No.	Description
<b>SXRFTOT3</b>	3" Full Extension Tote/Frame Assembly
<b>SXRFTOT6</b>	6" Full Extension Tote/Frame Assembly
<b>SXRFTOT9</b>	9" Full Extension Tote/Frame Assembly
<b>SXR3DIV</b>	3" Tote Divider Kit (Includes (2) Long Dividers & (6) Short Dividers)
<b>SXR3SDIV</b>	3" Short Divider Kit (3-Pack)
<b>SXR3LDIV</b>	3" Long Divider Kit (2-Pack)
<b>SXR6DIV</b>	6" Tote Divider Kit (Includes (2) Long Dividers & (6) Short Dividers)
<b>SXR6SDIV</b>	6" Short Divider Kit (3-Pack)
<b>SXR6LDIV</b>	6" Long Divider Kit (2-Pack)
<b>SXR3RDVR</b>	3" Eggcrate Style Tote Divider Kit
<b>SXR6RDVR</b>	6" Eggcrate Style Tote Divider Kit



Full Extension Tote and Basket

Full-Extension Baskets/Dividers

Cat. No.	Description
<b>SXRFBSK3</b>	3" Full Extension Basket/Frame Assembly
<b>SXRFBSK7</b>	7.5" Full Extension Basket/Frame Assembly
<b>SXRFB3SDIV</b>	3" Short Basket Dividers (3-Pack)
<b>SXRFB3LDIV</b>	3" Long Basket Dividers (2-Pack)
<b>SXRFB7SDIV</b>	7.5" Short Basket Dividers (3-Pack)
<b>SXRFB7LDIV</b>	7.5" Long Basket Dividers (2-Pack)



Baskets

Additional Baskets

Cat. No.	Description	Color	Qty.	Length/Height	
				(in.)	(mm)
<b>BSKT3</b>	3" (76mm) H. Basket	White	6	3 1/4 x 20 3/4 x 16 3/4	83 x 527 x 425
<b>BSKT7</b>	7" (178mm) H. Basket	White	6	7 1/4 x 20 3/4 x 16 3/4	184 x 527 x 425

Wire grid space: 1 1/8" x 1 1/8" (29 x 29mm)

To configure a Starsys unit to your exact specifications, please visit [www.metroconfigurator.com](http://www.metroconfigurator.com)



4 Level Cassette



Bins



Double-Wide, Double Sided Cassette Transfer Cart  
Cat. No. SXR43TRAN  
(shown with cassettes and bins, sold separately, see above)

Components — Polymer

Description	No. of Bins Per Level	Overall Dimensions Height/Width/Length (in.)	Overall Dimensions Height/Width/Length (mm)	Cat. No.
<b>Cassettes and Bins</b>				
1 Level Cassette Body		5 <sup>15</sup> / <sub>16</sub> x11 <sup>3</sup> / <sub>4</sub> x19 <sup>3</sup> / <sub>8</sub>	151x298x492	SXRCASB1
2 Level Cassette Body		8 <sup>15</sup> / <sub>16</sub> x11 <sup>3</sup> / <sub>4</sub> x19 <sup>3</sup> / <sub>8</sub>	277x298x492	SXRCASB2
3 Level Cassette Body		11 <sup>15</sup> / <sub>16</sub> x11 <sup>3</sup> / <sub>4</sub> x19 <sup>3</sup> / <sub>8</sub>	303x298x492	SXRCASB3
4 Level Cassette Body		14 <sup>15</sup> / <sub>16</sub> x11 <sup>3</sup> / <sub>4</sub> x19 <sup>3</sup> / <sub>8</sub>	379x298x492	SXRCASB4
5 Level Cassette Body		17 <sup>15</sup> / <sub>16</sub> x11 <sup>3</sup> / <sub>4</sub> x19 <sup>3</sup> / <sub>8</sub>	456x298x492	SXRCASB5
3" (76mm) wide Cassette Bin	6	2 <sup>9</sup> / <sub>16</sub> x11 <sup>15</sup> / <sub>16</sub> x2 <sup>1</sup> / <sub>16</sub>	65x303x68	SXRBINSB3
4 <sup>1</sup> / <sub>2</sub> " (114mm) wide Cassette Bin	4	2 <sup>9</sup> / <sub>16</sub> x11 <sup>15</sup> / <sub>16</sub> x4 <sup>1</sup> / <sub>16</sub>	65x303x103	SXRBINSB4
6" (152mm) wide Cassette Bin	3	2 <sup>9</sup> / <sub>16</sub> x11 <sup>15</sup> / <sub>16</sub> x5 <sup>1</sup> / <sub>2</sub>	65x303x140	SXRBINSB6
8" (203mm) wide Cassette Bin	2	2 <sup>9</sup> / <sub>16</sub> x11 <sup>15</sup> / <sub>16</sub> x8	65x303x203	SXRBINSB8

Note: Bins are shipped with one ID card.

Description	Cat. No.
<b>Bin Accessories</b>	
Cassette Bin Divider Kit (20 dividers)	SXRBINDIV
Cassette Label Kit (includes label strips in Mauve, Slate Blue and Jade for identification of bins)	SXRCASLAB
Cassette Bin Labels (5 sheets of Slate Blue bin labels — 18 of each size per sheet)	SXRBINLAB-BL
Cassette Bin Labels (5 sheets of Jade bin labels — 18 of each size per sheet)	SXRBINLAB-GR
Cassette Bin Labels (5 sheets of Mauve bin labels — 18 of each size per sheet)	SXRBINLAB-RD

SXRBINDIV divides up to 4 bins.

SXRCASLAB includes 3 sheets of labels. One sheet per color. Each sheet contains 18 labels for each size bin. It also includes 18 patient ID bin cards for each size bin and 4 cassette ID labels.

Cassette Transfer Carts

Description	(in.)	Overall Dimensions Height/Width/Length (mm)	Inside Height (in.)	Inside Height (mm)	Approx. Pkd. Wt. (lbs.)	Approx. Pkd. Wt. (kg)	Cat. No.
<b>Single-Wide, Double-Sided*</b>							
40" (1016mm) Single	39 <sup>3</sup> / <sub>4</sub> x24 <sup>7</sup> / <sub>8</sub> x22 <sup>1</sup> / <sub>16</sub>	1010x632x576	30 <sup>1</sup> / <sub>4</sub>	768	150	68	SXRS40TRAN
43" (1092mm) Single	42 <sup>3</sup> / <sub>4</sub> x24 <sup>7</sup> / <sub>8</sub> x22 <sup>1</sup> / <sub>16</sub>	1086x632x576	33 <sup>1</sup> / <sub>4</sub>	845	150	68	SXRS43TRAN
46" (1168mm) Single	45 <sup>3</sup> / <sub>4</sub> x24 <sup>7</sup> / <sub>8</sub> x22 <sup>1</sup> / <sub>16</sub>	1162x632x576	36 <sup>1</sup> / <sub>4</sub>	921	157	71	SXRS46TRAN
<b>Double-Wide, Double Sided*</b>							
40" (1016mm) Double	39 <sup>3</sup> / <sub>4</sub> x24 <sup>7</sup> / <sub>8</sub> x42 <sup>1</sup> / <sub>2</sub>	1010x632x1080	30 <sup>1</sup> / <sub>4</sub>	768	170	77	SXRD40TRAN
43" (1092mm) Double	42 <sup>3</sup> / <sub>4</sub> x24 <sup>7</sup> / <sub>8</sub> x42 <sup>1</sup> / <sub>2</sub>	1086x632x1080	33 <sup>1</sup> / <sub>4</sub>	845	176	80	SXRD43TRAN
46" (1168mm) Double	45 <sup>3</sup> / <sub>4</sub> x24 <sup>7</sup> / <sub>8</sub> x42 <sup>1</sup> / <sub>2</sub>	1162x632x1080	36 <sup>1</sup> / <sub>4</sub>	921	181	82	SXRD46TRAN

\*Cassette storage available on both front and back of cart.

Starsys™ Single Bin Access Cassette System

Cassette shown in "Single Bin Access" Mode



Detail of Turn Latch

Cassette shown in "Full Level" Mode



Starsys Carts are built to exact customer specifications, therefore, they are non-cancelable, non-returnable.  
For Starsys pricing information, please contact your local Metro representative.

## Shelves & Accessories for Units with qwikSLOT Inserts

### Wire Shelves

Cat. No.	Description
<b>SXRSWQ</b>	Single Wide QS Wire Shelf
<b>SXRSWAR</b>	Single Wide Full Extension Wire Shelf (Right Thumb Latch)
<b>SXRSWAL</b>	Single Wide Full Extension Wire Shelf (Left Thumb Latch)
<b>SXRDWQ</b>	Double Wide QS Wire Shelf
<b>SXRDWAR</b>	Double Wide Full Extension Wire Shelf (Right Thumb Latch)
<b>SXRDWAL</b>	Double Wide Full Extension Wire Shelf (Left Thumb Latch)
<b>2148CI-4</b>	Clear Inlays for Wire Shelves (4-Pk)
<b>9990P7</b>	Label Holder for Single Wide Wire Shelf
<b>9990P8</b>	Label Holder for Double Wide Wire Shelf
<b>SXRSLDG</b>	4"H Wire Shelf Ledge
<b>SXRSLFDIV</b>	4"H Wire Shelf Divider
<b>SXRSLFDIV8</b>	8"H Wire Shelf Divider



SXRSLDG Ledge

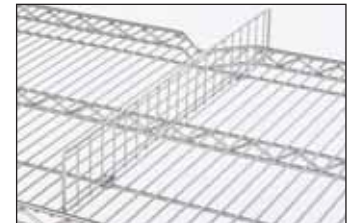

SXRSLFDIV

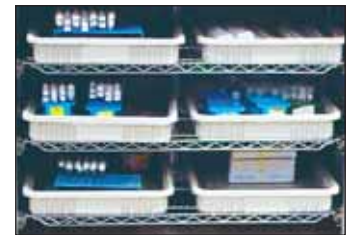

Metro Totes

### Metro Totes

Outside Dimensions (Includes lip) Length x Width (in.)		Inside Dimensions Length x Width (mm)		Height O.D. (mm)		I.D.* (in.) (mm)		Capacity (cu. ft.) (cu. m.)		Approx. Tote Box Wt. (lbs.)	Cat. No.
22½ x 17½	572 x 445	20¼ x 15½	514 x 384	3	76	2.5	64	.44	0.017	2.57	<b>MTB93030W</b>
22½ x 17½	572 x 445	20¼ x 15½	514 x 384	5	127	4.5	114	.79	0.02	4.0	<b>MTB93050W</b>
22½ x 17½	572 x 445	20¼ x 15½	514 x 384	6	152	5.5	140	.97	0.027	4.0	<b>MTB93060W</b>
22½ x 17½	572 x 445	20¼ x 15½	514 x 384	8	203	7.5	191	1.32	0.037	5.25	<b>MTB93080W</b>
22½ x 17½	572 x 445	20¼ x 15½	514 x 384	12	305	11.5	292	2.03	0.057	6.67	<b>MTB93120W</b>

\*Loading height restrictions when using covers or stacking totes.  
**Note:** Other Metro totes available. See page 156.

### Dividers

For Tote Box	Dividers	Maximum Tote	For Tote Box	Dividers	Maximum Tote
MTB93030W	Short <b>MDS93030NAT</b>	15	MTB93080W	Short <b>MDS93080NAT</b>	15
	Long <b>MDL93030NAT</b>	11		Long <b>MDL93080NAT</b>	11
MTB93060W	Short <b>MDS93060NAT</b>	15	MTB93120W	Short <b>MDS93080NAT</b>	15
	Long <b>MDL93060NAT</b>	11		Long <b>MDL93080NAT</b>	11

### Heavy-Duty Drawers & Accessories

All Starsys Heavy-Duty drawers have an interior front-to-back dimension of 19.188" (487mm). Single Heavy-Duty drawers have an interior width of 16.375" (416mm). Double Heavy-Duty drawers have an interior width of 36.250" (920mm).

Description	Interior Depth (in.) (mm)	Cat. No.
<b>Heavy-Duty Drawers — Single</b>		
3" (76mm) SW Starsys Heavy-Duty Drawer	2¾ 60	<b>SXRS3HD</b>
6" (152mm) SW Starsys Heavy-Duty Drawer	5¾ 136	<b>SXRS6HD</b>
9" (229mm) SW Starsys Heavy-Duty Drawer	8¾ 213	<b>SXRS9HD</b>
12" (305mm) SW Starsys Heavy-Duty Drawer	11¾ 289	<b>SXRS12HD</b>
Single-Wide Drawer Top No Lock (Used when shelf is required directly over a drawer or door.)		<b>SXRSHDWRTOP</b>
<b>Heavy-Duty Drawers — Double</b>		
3" (76mm) DW Starsys Heavy-Duty Drawer	2¾ 60	<b>SXRD3HD</b>
6" (152mm) DW Starsys Heavy-Duty Drawer	5¾ 136	<b>SXRD6HD</b>
9" (229mm) DW Starsys Heavy-Duty Drawer	8¾ 213	<b>SXRD9HD</b>
12" (305mm) DW Starsys Heavy-Duty Drawer	11¾ 289	<b>SXRD12HD</b>
Double-Wide Drawer Top No Lock (Used when shelf is required directly over a drawer or door.)		<b>SXRDHDWRTOP</b>
<b>Heavy-Duty Drawer Dividers — Single</b>		
3" (76mm) SW Drawer Divider Kit		<b>SXRS3HDIV</b>
6" (152mm) SW Drawer Divider Kit		<b>SXRS6HDIV</b>
<b>Heavy-Duty Drawer Dividers — Double</b>		
3" (76mm) DW Drawer Divider Kit		<b>SXRD3HDIV</b>
6" (152mm) DW Drawer Divider Kit		<b>SXRD6HDIV</b>
<b>Drawer Label Kits</b>		
Label Kit		<b>SXRLABKIT</b>



Heavy-Duty Drawer

Drawer Pulls (one required per drawer) To specify color for drawer pull, order following catalog numbers for each drawer:

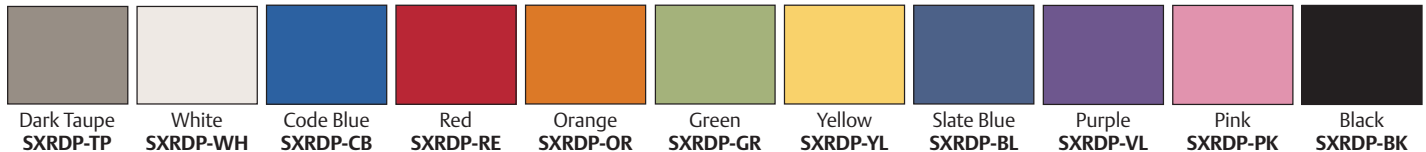

Dark Taupe **SXRDP-TP**    White **SXRDP-WH**    Code Blue **SXRDP-CB**    Red **SXRDP-RE**    Orange **SXRDP-OR**    Green **SXRDP-GR**    Yellow **SXRDP-YL**    Slate Blue **SXRDP-BL**    Purple **SXRDP-VL**    Pink **SXRDP-PK**    Black **SXRDP-BK**

To configure a Starsys unit to your exact specifications, please visit [www.metroconfigurator.com](http://www.metroconfigurator.com)



SXR243



SXRMON



SXRLAP

Corner Accessories

Description	Dimensions — Inches (millimeters)	Cat. No.
Articulating Laptop Arm	18" Extension, 10" Vertical Range	<b>SXR LAP</b>
Articulating LCD Monitor Arm	Includes: 75 & 100mm VESA adapters	<b>SXR MON</b>
Articulating Tablet PC Arm	Rotates for Writing or Drawing	<b>SXR TAB</b>
Articulating Arm Mounting Pole*	Order with Laptop, Monitor or Tablet Arms	<b>SXR-ARMPOLE</b>
Hospital Grade Power Strip & Cord Wrap	6 Outlets, 15" Cord	<b>SXR595</b>
I.V. Utility Pole	Attaches directly to left or right rear cart corner	<b>SXRIV</b>
Peel Pouch/Catheter Holder-18"	18H (457) x 6W (152) x 3D (76)	<b>SXR240</b>
Peel Pouch/Catheter Holder-28"	27H (686) x 6W (152) x 3D (76)	<b>SXR243</b>

\*Mounting pole ordered separately.



Accessorized Pods on Starsys cart

Side Pods — All side pods are 30"H x 19.5"W x 6"L (762 x 483 x 152mm)

Description	Cat. No.
Fixed Side Pod (Non-Locking)	<b>SXRPOD</b>
Fixed Side Pod (with Top-Locking Tilt Bin)*	<b>SXRPODK1</b>
Fixed Side Pod (with 3-Locking Tilt Bins)**	<b>SXRPODK3</b>
Left Swing-out Side Pod (Non-Locking)	<b>SXRPODSL</b>
Left Swing-out Side Pod (with Top-Locking Tilt Bin)*	<b>SXRPODSLK1</b>
Left Swing-out Side Pod (with 3 Locking Tilt Bins)**	<b>SXRPODSLK3</b>
Right Swing-out Side Pod (Non-Locking)	<b>SXRPODSR</b>
Right Swing-out Side Pod (with Top Locking Tilt Bin)*	<b>SXRPODSRK1</b>
Right Swing-out Side Pod (with 3-Locking Tilt Bins)**	<b>SXRPODSRK3</b>

\*Top Tray with Dividers and Tilt Bin included.

\*\*Top Tray with Dividers and 3 Tilt Bins included.



SXR GAS

Side Pod Accessories

Description	Dimensions — Inches (millimeters)	Cat. No.
Chart Holder	9 <sup>9</sup> / <sub>16</sub> H (242) x 11 <sup>1</sup> / <sub>2</sub> W (292) x 4 3/4L (121)	<b>SXRCHRT</b>
Containment Shelf Ledge	1 <sup>1</sup> / <sub>2</sub> H (38) 16L (406) x 3 <sup>1</sup> / <sub>2</sub> D (89)	<b>SXRPODL DGE</b>
Cup Holder <sup>2</sup>	Cup Sizes: 1 <sup>3</sup> / <sub>8</sub> (35), 2 (51), 2 <sup>1</sup> / <sub>2</sub> (64)	<b>SXRCUP</b>
Gas Tank Holder <sup>3</sup>	Holds C, D and E Tanks	<b>SXRGAS-H</b>
Glove Box Holder — Single	6 <sup>1</sup> / <sub>8</sub> H (156) x 10 <sup>1</sup> / <sub>8</sub> W (258) x 4L (102)	<b>FL236</b>
Glove Box Holder — Triple	18 <sup>1</sup> / <sub>4</sub> H (464) x 10 <sup>1</sup> / <sub>8</sub> W (258) x 5 <sup>1</sup> / <sub>2</sub> L (140)	<b>FL237</b>
Lockable Sharps Container & Glove Box	18 <sup>1</sup> / <sub>4</sub> H (464) x 13W (330) x 5 <sup>1</sup> / <sub>2</sub> L (140)	<b>SXR251</b>
Lockable Sharps Replacement Containers	20/Pack, 5 Qt. (4.7L) Capacity	<b>SXRMF252</b>
Sharps Container Holder	9.3H (236) x 8W (203) x 3L (76)	<b>SXRSHRPS</b>
Tilt Out Bin	7 <sup>1</sup> / <sub>2</sub> H (191) 16L (406) x 3 <sup>1</sup> / <sub>2</sub> D (89)	<b>SXRPODBIN</b>
Top Tray (with 3 Dividers) <sup>1</sup>	2 <sup>1</sup> / <sub>2</sub> H (57) x 16 <sup>7</sup> / <sub>8</sub> W (429) x 4 <sup>3</sup> / <sub>8</sub> L (111)	<b>SXRPODTRY</b>
Unit Shelf	4 <sup>1</sup> / <sub>2</sub> D (115) x 16 <sup>7</sup> / <sub>8</sub> D (429) x 16 <sup>7</sup> / <sub>8</sub> W (429)	<b>SXRPODSLHLF</b>
Waste Basket & Holder	Holder: 15.5H (394) x 8W (203) x 3L (76)	<b>SXRBSKT-H</b>
Waste Basket Only	12 <sup>1</sup> / <sub>4</sub> H (311) x 11 <sup>1</sup> / <sub>4</sub> W (286) x 8 <sup>1</sup> / <sub>4</sub> D (210)	<b>SXRBSKT</b>

<sup>1</sup>Attached to top of Unit Shelf (SXRFULSHLF).

<sup>2</sup>Attaches to top of Unit Shelf (SXRFULSHLF).

<sup>3</sup>One or two allowed on Fixed Non-Locking Pods Only.



SXRPODL DGE



SXRPODBIN

Starsys Carts are built to exact customer specifications, therefore, they are non-cancelable, non-returnable.

For Starsys pricing information, please contact your local Metro representative.



### Side Accessory Bracket

Description	Dimensions — Inches (millimeters)	Cat. No.
Side Accessory Bracket	4 <sup>3</sup> / <sub>8</sub> H (111) x 19 <sup>3</sup> / <sub>8</sub> W (492)	<b>SXR205</b>



SX205 Accessory Bracket

### Side Accessory Bracket Accessories

Description	Dimensions — Inches (millimeters)	Cat. No.
Chart Holder <sup>1</sup>	9 <sup>9</sup> / <sub>16</sub> H (242) x 11 <sup>1</sup> / <sub>2</sub> W (292) x 4 <sup>3</sup> / <sub>4</sub> L (121)	<b>SXRCHRT</b>
Gas Tank Holder — Single <sup>2</sup>	Holds C, D and E Tanks	<b>SXRGAS-H</b>
Glove Box Holder — Single <sup>1</sup>	6 <sup>1</sup> / <sub>8</sub> H (156) x 10 <sup>1</sup> / <sub>8</sub> W (258) x 4L (102)	<b>FL236</b>
Glove Box Holder — Triple <sup>2</sup>	18 <sup>1</sup> / <sub>4</sub> H (464) x 10 <sup>1</sup> / <sub>8</sub> W (258) x 4L (102)	<b>FL237</b>
Lockable Sharps Container and Glove Box <sup>1</sup>	18 <sup>1</sup> / <sub>4</sub> H (464) x 13W (330) X 5 <sup>1</sup> / <sub>2</sub> L (140)	<b>SXR251</b>
Lockable Sharps Replacement Containers	20/Pack, 5 Qt. (4.7L) Capacity	<b>SXRMF252</b>
Sharps Container Holder <sup>1</sup>	9.3H (236) x 8W (203) x 3L (76)	<b>SXRSHRPS</b>
Side Bins (3 Pack) <sup>3</sup>	4 (102) x 4 <sup>1</sup> / <sub>2</sub> (114) x 18 <sup>3</sup> / <sub>8</sub> (254)	<b>MBP216</b>
Waste Basket and Holder <sup>1</sup>	Holder: 15.5H (394) x 8W (203) x 3L (76)	<b>SXRBSKT-H</b>
Waste Basket Only	12 <sup>1</sup> / <sub>4</sub> H (311) x 11 <sup>1</sup> / <sub>4</sub> W (286) x 8 <sup>1</sup> / <sub>4</sub> D (210)	<b>SXRBSKT</b>

\*Accessory Bracket(s) included.  
<sup>1</sup>Order with (1) SXR205 Accessory Bracket.  
<sup>2</sup>Order with (2) SXR205 Accessory Brackets.  
<sup>3</sup>Order with (3) SXR205 Accessory Brackets



SXR205, SXR251

### Other Accessories

Description	Dimensions — Inches (millimeters)	Cat. No.
Extended Handle	4H (102) x 21 <sup>1</sup> / <sub>2</sub> W (546) x 4 <sup>1</sup> / <sub>4</sub> L (108)	<b>SXREHAN</b>
Extended Handle (Field Retrofit)	4H (102) x 21 <sup>1</sup> / <sub>2</sub> W (546) x 4 <sup>1</sup> / <sub>4</sub> L (108)	<b>SXREHAN-KD</b>
Pullout Writing Surface (Left Side)	17.5"W (445) x 15.75"L (400); (25 lb. cp.)	<b>SXRPULLOUTL</b>
Pullout Writing Surface (Right Side)	17.5"W (445) x 15.75"L (400); (25 lb. cp.)	<b>SXRPULLOUTR</b>
Single Wide Full-Extension Keyboard Tray	16 <sup>3</sup> / <sub>8</sub> " (417) x 13 <sup>5</sup> / <sub>8</sub> "L (346) x 2 <sup>5</sup> / <sub>8</sub> " (67)	<b>SXRSKBT</b>
Double Wide Full-Extension Keyboard Tray	36 <sup>1</sup> / <sub>4</sub> " (920) x 13 <sup>5</sup> / <sub>8</sub> "L (346) x 2 <sup>5</sup> / <sub>8</sub> " (67)	<b>SXRDKBT</b>
Backlit Keyboard with Clear Cover (Fits Single or Double Wide KBD Trays)		<b>SXRKBD</b>



SXRPULLOUTL



SXRSKBT



SXRDKBT



SXRKBD

### Overbridge and Accessories

Description	Cat. No.
(A) Overbridge Assembly with two Hanger Rails**	<b>SXRSOB</b>
Overbridge Assembly with no Hanger Rails	<b>SXRSOB-1000</b>
(B) Hanger Rail (2 <sup>3</sup> / <sub>16</sub> " [55mm] H.x1" [25.4mm] W.x19 <sup>1</sup> / <sub>2</sub> " [495mm] L. usable space	<b>SXROBSRAIL</b>
Overbridge with Top Shelf and Hanger Rail	<b>SXR515</b>
Overbridge with 2 Shelves	<b>SXR520</b>
Overbridge Shelf***	<b>SXR560</b>
Utility Pole Including Universal Clamp (Attaches to Overbridge)	<b>SXR566</b>
Universal Clamp	<b>SXR570</b>
Short Utility Hook (package of 4) (3 <sup>1</sup> / <sub>2</sub> " [89mm] usable length)	<b>SXR571</b>
Laryngoscope Blade/Specimen Holder	<b>SXR575</b>
(C) Half-Size Metal Utility Bin (5 <sup>1</sup> / <sub>2</sub> " [140mm] H.x5 <sup>1</sup> / <sub>2</sub> " [140mm] W.x5 <sup>3</sup> / <sub>4</sub> " [146mm] L.)	<b>SXR581</b>
(D) Full-Size Metal Utility Bin (5 <sup>1</sup> / <sub>2</sub> " [140mm] H.x5 <sup>1</sup> / <sub>2</sub> " [140mm] W.x11 <sup>5</sup> / <sub>8</sub> " [292mm] L.)	<b>SXR582</b>
Label/Tape Dispenser	<b>SXR583</b>
Wire Supply Basket (7" [178mm] H.x5" [127mm] W.x17" [432mm] L.)	<b>SXR585</b>
(E) Utility Bin with Cover (Package of 6)	<b>SXR586</b>
†† Sharps Container Bracket	<b>LEC9800</b>
Tilt Bin 3 Units with Brackets	<b>SXRMF543</b>
Tilt Bin 4 Units with Brackets	<b>SXRMF544</b>
Tilt Bin 6 Units with Brackets	<b>SXRMF546</b>



SXREHAN



SXRSOB Overbridge Assembly (shown with optional accessories)

\*\* Maximum weight capacity for overbridge assembly is 40 lbs. (18.1kg).  
\*\*\* Maximum weight capacity for overbridge shelf is 40 lbs. (18.1kg).  
† Mounts to universal clamp in addition to hanger rail.  
†† Mounts to I.V. pole or utility pole.

To configure a Starsys unit to your exact specifications, please visit [www.metroconfigurator.com](http://www.metroconfigurator.com)

## Solutions That Move You. Mobile, Modular, Metro.



Unit shown with optional sloped top.



Tall Mobile Units are stand-alone products. Tall mobile units are available in single (22<sup>3</sup>/<sub>4</sub>" [578mm]), double (42<sup>1</sup>/<sub>2</sub>" [1080mm]) and triple (62<sup>1</sup>/<sub>2</sub>" [1588mm]) widths. The overall height of a tall mobile unit is 78" (1981mm). All units are 24<sup>7</sup>/<sub>8</sub>" (632mm) deep.

#### General Overview:

The configurable interior space is 66" (1676mm).

Triple-width units must be divided into a single & double bay or three single bays — there are no triple wide accessories.

The specification of a qwikSLOT interior or an empty interior will necessitate an extended mobile base as part of the configuration.

Starsys Mobile Units have a total recommended load rating of 900 lbs. (408kg) including the weight of the Starsys unit.

Units feature two 5" (127mm) casters — the front two casters have color-matched toe-brakes.

Tall Stationary Units are stand-alone products or may be used in conjunction with other tall units or Starsys product families. Tall stationary units are available in single and double widths only.

#### General Overview:

The overall height of a tall stationary unit is 72<sup>1</sup>/<sub>2</sub>" (1842mm). Add 11<sup>3</sup>/<sub>4</sub>" (299mm) wth sloped tops.

The configurable interior space is 66" (1676mm). The overall widths are 21<sup>1</sup>/<sub>2</sub>" (546mm) for singles and 41<sup>1</sup>/<sub>3</sub>" (1049mm) for doubles.

Filler kits are available to fill gaps between units, between the back of a unit and the wall (25" [635mm] & 30" [762mm] depths) and between tall units interfacing at 45 or 90 degrees.

All tall units must be affixed to the wall with appropriate mounting hardware utilizing the attached Starsys mounting bracket or affixed to the floor with the optional floor mounting kit.

Tall units are not intended to support cantilevered countertop sections.

Starsys Carts are built to exact customer specifications, therefore, they are non-cancelable, non-returnable.

For Starsys pricing information, please contact your local Metro representative.



Cat. No. SXRSGS1



Cat. No. SXRSGS2



Cat. No. SXRS76CM5



Cat. No. SXRS76CMHD2



Cat. No. SXRD76CM3



Cat. No. SXRD76CMHD1



Cat. No. SXRTGS2



Cat. No. SXRTGS3



Cat. No. SXRS72TU2



Cat. No. SXRS72TU4



Cat. No. SXRS72TUHD2

To configure a Starsys unit to your exact specifications, please visit [www.metroconfigurator.com](http://www.metroconfigurator.com)

For specification details, consult page 210



Cat. No. **SXRD72TU2**



Cat. No. **SXRD72TU3**



Cat. No. **SXRD72TU6**

### Accessories

Description	Cat. No.
Extended Handle Assembly 4" (102mm) H.x21 <sup>1</sup> / <sub>2</sub> " [546mm] W.x 4 <sup>1</sup> / <sub>4</sub> " [108mm] L.)	<b>SXREHAN†</b>
Extended Handle Assembly — KD	<b>SXREHAN-KD</b>
Coat Hanger Tube	<b>SXRSHANG</b>

†Unless otherwise requested, handle will be assembled on left side of unit.



Extended Handle

### Filler Kits and Trim Kits — Tall Stationary Units

Description	Cat. No.
Unit to Unit Filler Strip Kit	<b>SXR72UUFLR</b>
Back Wall Trim Kit x 72" (1829mm)	<b>SXR72BKFLR</b>
Back Wall Trim Kit x 72" (1829mm) — 30" (762mm) Deep	<b>SXR72BKFLR30</b>
45° Corner Filler Strip Kit x 84" (2134mm)	<b>SXR84CR45FLR</b>
90° Corner Filler Strip Kit x 84" (2134mm)	<b>SXR84CR90FLR</b>



Coat Hanger Tube

### Floor Mounting Kit

Description	Cat. No.
Floor Mounting Kit	<b>SX-FLR</b>



StarSys Carts are built to exact customer specifications, therefore, they are non-cancelable, non-returnable.  
For StarSys pricing information, please contact your local Metro representative.



## Solutions That Move You. Mobile, Modular, Metro.



Overhead cabinet shelves are removable, easy-to-clean, and are available in both solid polymer and epoxy-coated, open-wire shelf designs.

Starsys mobile workcenter units can be specified with or without overhead cabinets attached. Available overhead heights include 24", 27", 30", and 36".

Overhead cabinet accessories include light fixture, cassette bins for small item storage and organization, and poly shelf dividers.

Overhead cabinets can be specified with a variety of available doors, clear or solid style, locking or non-locking. Contact your Metro representative for more information.

Pre-configured units are available with black epoxy countertops. Standard countertop choices include stainless steel, Trespa® and Corian®. For other options, including laminate, contact your Metro representative.

Door handle detail is GMP compliant and can be accented with choice of 8 available colors.

Microban® Antimicrobial Product Protection inhibits the growth of stain and odor-causing bacteria on Starsys, keeping the surface areas "cleaner between cleanings."

Starsys Doors, available in multiple heights, can be specified with or without window, as well as locking and non-locking.

Drawer pull is GMP compliant and can be accented with choice of 8 available colors.

5" (127mm) total-lock polymer casters with easily accessible toe brakes make unit easy to maneuver in tight lab spaces. Other caster options are shown on page 217.

Starsys drawer options include choice of polymer drawers (3", 4½", 6", 7½", 9", 10½", and 12" heights) or heavy-duty drawers (3", 6", 9" and 12" heights), featuring stainless steel drawer interior, load-rated at 150 lbs. per drawer. Heavy-duty drawers are available in both single- and double-wide modules.



Starsys Mobile WorkCenters are built for change. They allow you to easily adapt to a changing work environment and even inspire change in your work environment.

Available Widths: Starsys Mobile WorkCenters are available in four widths; single, double, triple & single-kneewell-single.

Working Heights: Available working heights without overhead storage: 33", 36", 39", 42", 45" (with 5" casters). Deduct 2" (51mm) from unit height when specifying 3" Total-Lock casters or Leveling casters.

Total Unit Height: All units with overhead storage have a total height of 82" (2083mm) (with 5" casters). Deduct 2" from unit height when specifying 3" Total-Lock casters or Leveling casters.

Countertop Heights available with Overheads: 33", 36", 39", 42" (45" height is not available with overhead storage)

Available Configuration Widths: (without side pods)

Single: 23.6" (600mm)

Double: 43.4" (1103mm)

Triple: 63.2" (1606mm)

Single-Kneewell-Single: 73.0" (1855mm)

Countertops: 29" depth, available with back splash or island style (when overheads are not specified) in black epoxy, Trespa®, Corian® or stainless steel. Side splashes are available for units with back splash.

Kneewell Options: Starsys Mobile WorkCenter configurations have several kneewell options including a keyboard tray, pencil drawer (drawer pull specified separately) and support bracket. The triple unit has a right oriented kneewell option with a nominal opening of 42" (1067mm) and the single-kneewell-single configuration has a nominal opening of 30" (762mm). The kneewell area in both of these configurations is supported by a bracket assembly in the event that neither the keyboard nor pencil drawer option is specified.

To configure a Starsys unit to your exact specifications, please visit [www.metroconfigurator.com](http://www.metroconfigurator.com)

For specification details, consult page 213

Preconfigured Mobile WorkCenters with Epoxy Tops — 46.01

All preconfigured units below come standard with taupe door/drawer pulls and polymer 5" (127mm) diameter casters (2-total lock, 2-swivel). Overhead units include 27" (686mm) cabinets with locking clear doors and two poly shelves. The countertops are 1" (25mm) thick black epoxy resin. Other top materials and accessories are available upon request.

Description	Cat. No.	Overall Dimensions Width/Length/Height	Cat. No. With Overhead	Overall Dimensions Width/Length/Height
<b>Single-Wide Units</b>				
Single-Wide Heavy-Duty 12" (305mm) (2)	<b>SXRMWS33EBS1</b>	28.6x23.6x33.5		
Single-Wide with Standard Drawers	<b>SXRMWS36EBS2</b>	28.6x23.6x36.5	<b>SXRMWS36EOH2</b>	28.6x23.6x81.5
Single-Wide with Locking Doors and Poly Shelves	<b>SXRMWS36EBS3</b>	28.6x23.6x36.5	<b>SXRMWS36EOH3</b>	28.6x23.6x81.5
<b>Double-Wide Units</b>				
Double-Wide Heavy-Duty 12" (305mm) (2)	<b>SXRMWD33EBS1</b>	28.6x43.4x33.5		
Double-Wide with Standard Drawers	<b>SXRMWD36EBS2</b>	28.6x43.4x36.5	<b>SXRMWD36EOH2</b>	28.6x43.4x81.5
Double-Wide with Locking Doors and Poly Shelves	<b>SXRMWD36EBS3</b>	28.6x43.4x36.5	<b>SXRMWD36EOH3</b>	28.6x43.4x81.5
<b>Triple-Wide Units</b>				
Triple-Wide with S & D HD Drawers	<b>SXRMWT36EBS6</b>	28.6x63.2x36.5	<b>SXRMWT36EOH6</b>	28.6x63.2x81.5
Triple-Wide with Locking Doors and Wire Shelves	<b>SXRMWT36EBS4</b>	28.6x63.2x36.5		
Triple-Wide with Locking Doors and Poly Shelves			<b>SXRMWT36EOH3</b>	28.6x63.2x36.5
Triple Kneewell with Standard Drawers	<b>SXRMWTK36EBS2</b>	28.6x63.2x36.5	<b>SXRMWTK36EOH2</b>	28.6x63.2x81.5
Triple Kneewell with Locking Doors and Poly Shelves	<b>SXRMWTK36EBS3</b>	28.6x63.2x36.5	<b>SXRMWTK36EOH3</b>	28.6x63.2x81.5
Triple Kneewell with Standard Drawers	<b>SXRMWTK39EBS2</b>	28.6x63.2x39.5		
Triple Kneewell with Locking Doors and Poly Shelves	<b>SXRMWTK39EBS3</b>	28.6x63.2x39.5		
Single Kneewell with HD Drawers	<b>SXRMWSK33EBS1</b>	28.6x73x33.5		
Single Kneewell with Standard Drawers	<b>SXRMWSK39EBS2</b>	28.6x73x39.5		
Single Kneewell with Locking Doors and Poly Shelves	<b>SXRMWSK39EBS3</b>	28.6x73x39.5		



Cat. No. **SXRMWS33EBS1**



Cat. No. **SXRMWS36EBS2**



Cat. No. **SXRMWS36EBS3**



Cat. No. **SXRMWD33EBS1**



Cat. No. **SXRMWD36EBS2**



Cat. No. **SXRMWD36EBS3**



Cat. No. **SXRMWT36EBS4**



Cat. No. **SXRMWT36EBS6**

\*Trespa Phenolic, Laminate and Stainless Steel tops are available. Contact your Metro representative.  
 Starsys Carts are built to exact customer specifications, therefore, they are non-cancelable, non-returnable.  
 For Starsys pricing information, please contact your local Metro representative.

Mobile WorkCenters with Epoxy Tops and Overheads\*



Cat. No. SXRMTK36EBS2



Cat. No. SXRMTK36EBS3



Cat. No. SXRMTK39EBS2



Cat. No. SXRMTK39EBS3



Cat. No. SXRMSK33EBS1



Cat. No. SXRMSK39EBS2



Cat. No. SXRMSK39EBS3



Cat. No. SXRMS36EOH2



Cat. No. SXRMS36EOH3



Cat. No. SXRMD36EOH2

\*Trespa Phenolic, Laminate and Stainless Steel tops are available. Contact your Metro representative.

To configure a Starsys unit to your exact specifications, please visit [www.metroconfigurator.com](http://www.metroconfigurator.com)

For specification details, consult page 213

Mobile WorkCenters with Epoxy Tops and Overheads\*



Cat. No. **SXRMWD36EOH3**



Cat. No. **SXRMWT36EOH6**



Cat. No. **SXRMWT36EOH3**



Cat. No. **SXRMWTK36EOH2**



Cat. No. **SXRMWTK36EOH3**



\*Trespa Phenolic, Laminate and Stainless Steel tops are available. Contact your Metro representative. Starsys Carts are built to exact customer specifications, therefore, they are non-cancelable, non-returnable. For Starsys pricing information, please contact your local Metro representative.



### Starsys Drawers

Starsys offers two types of drawers to address varying user requirements. Below is a feature comparison to help determine the appropriate drawers system for a desired application.

Feature	Polymer Drawers	Heavy-Duty Drawers
Light to medium weight capacity (25-40 lbs.)	X	
Heavy weight capacity (up to 150 lbs.)		X
Removable tote	X	
Inner panel compatible	X	
Slotted post insert compatible		X
Ball bearing slide		X
Full extension	X	X
Stainless steel interior		X
Polymer interior	X	
Easy to clean	X	
Easily removed/reconfigured	X	
Adjustable dividers	X	X
Lockable	X	X
Optional lock cover	X	
Label kits	X	X
Accommodate hanging files		X



Removable drawer totes allow for exchange or convenient access outside of cart (Page 205)

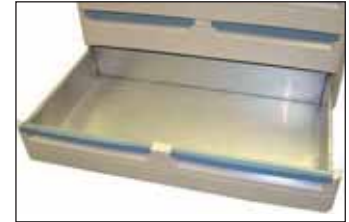

Heavy-Duty Drawer (Page 207)

### Starsys™ Doors

Starsys offers two types of doors, hinged and tambour. The hinged doors are available in a choice of solid or clear. Each offers unique benefits to address varying user requirements. Below is a feature comparison to help determine the appropriate door selection for a desired application.

Feature	Hinged Solid Door	Hinged Clear Door	Benefit
Visual Security	X		Puts inventory out of plain site
Hides clutter	X		Enhances department aesthetics
Visual inventory		X	Protection is not compromised when looking for supplies
Lockable	X	X	Added security
Space saving			Does not encroach on work space
Door swing overlaps	X	X	Promotes door closure to protect supplies adjacent storage spaces
90 degree hinge	X	X	Prevents door from overlapping adjacent space
270 degree hinge	X	X	Allows door to swing to side of cabinet or cart
Polymer	X	X	Impact and corrosion protection
Left or right hinge	X	X	Provides appropriate swing direction
Center closing	X	X	Allows for double wide storage compartments
Door label holders	X	X	Provides clean replenishable labeling option
Non-locking	X	X	Lower cost alternative



Solid Doors



Clear Door

### Starsys Cart Accessory Casters

Standard Starsys Mobile Unit Casters. All mobile units come standard with these casters.

Description	Cat. No.
(2) Front Polymer 5" (127mm) Total-Lock Casters	<b>B5P-TL</b>
(2) Rear Polymer 5" (127mm) Swivel Casters	<b>B5P-SW</b>

### Caster Options

<p>3" (76mm) Total-Lock Caster: Utilize 3" total-lock plate casters for limited mobile applications or when additional storage area is required.</p>  <p>B3P-TL</p>	<p>5" (127mm) Stainless Steel Caster: Recommended for corrosive environments.</p>  <p>B5PBGSA</p>	<p>5" (127mm) Total-Lock, All-Polymer Caster: Recommended for corrosive environments. All-polymer total-lock plate caster is an economical alternative to stainless casters.</p>  <p>B5PC-TL</p>	<p>Stabilizer/Leveling Caster: Recommended for applications where benchtop equipment demands unit stability and/or a level worksurface. Engage caster foot for stability, release for mobility.</p>  <p>B3N-AS</p>
<p>5" (127mm) Swivel/Lock (Directional) Casters (available by request) Other specialty caster options are available, consult your Metro representative.</p>			

To configure a Starsys unit to your exact specifications, please visit [www.metroconfigurator.com](http://www.metroconfigurator.com)

## Mobile WorkCenter Countertop Options Epoxy Tops — Mobile WorkCenters



Mobile WorkCenter with Epoxy Top

Description	Cat. No.
<b>Tops with Backsplash</b>	
Epoxy Top 21" (533mm) L. Backsplash — Black	<b>SXRCT2B23EB</b>
Epoxy Top 42" (1067mm) L. Backsplash — Black	<b>SXRCT2B43EB</b>
Epoxy Top 63" (1600mm) L. Backsplash — Black	<b>SXRCT2B63EB</b>
Epoxy Top 73" (1854mm) L. Backsplash — Black	<b>SXRCT2B73EB</b>
<b>Island Tops — No Backsplash</b>	
Epoxy Top 21" (533mm) L. No Backsplash — Black	<b>SXRCT2N23EB</b>
Epoxy Top 42" (1067mm) L. No Backsplash — Black	<b>SXRCT2N43EB</b>
Epoxy Top 63" (1600mm) L. No Backsplash — Black	<b>SXRCT2N63EB</b>
Epoxy Top 73" (1854mm) L. No Backsplash — Black	<b>SXRCT2N73EB</b>
<b>Tops with Backsplash and Overheads</b>	
Epoxy Top 21" (533mm) L. Backsplash Overhead — Black	<b>SXRCT2U23EB</b>
Epoxy Top 42" (1067mm) L. Backsplash Overhead — Black	<b>SXRCT2U43EB</b>
Epoxy Top 63" (1600mm) L. Backsplash Overhead — Black	<b>SXRCT2U63EB</b>
Epoxy Top 73" (1854mm) L. Backsplash Overhead — Black	<b>SXRCT2U73EB</b>
<b>Epoxy Top Brackets — Not Required for Island Tops</b>	
Single Epoxy Countertop Back Bracket	<b>SXRSEB</b>
Double Epoxy Countertop Back Bracket	<b>SXRDEB</b>
Triple Epoxy Countertop Back Bracket	<b>SXRTEB</b>
<b>Side Splash Options</b>	
Epoxy Side Splash — Black	<b>SXRCN2EB</b>
Epoxy Side Splash Overhead — Black	<b>SXRCN2EB</b>



Mobile WorkCenter with Stainless Steel Top

## Stainless Steel Tops — Mobile WorkCenters

Description	Cat. No.
<b>Tops with Backsplash</b>	
Stainless Steel Mobile WorkCenter Countertop — Single Backsplash	<b>SXRCT2B23S</b>
Stainless Steel Mobile WorkCenter Countertop — Double Backsplash	<b>SXRCT2B43S</b>
Stainless Steel Mobile WorkCenter Countertop — Triple Backsplash	<b>SXRCT2B63S</b>
Stainless Steel Mobile WorkCenter Countertop — S-KW-S Backsplash	<b>SXRCT2B73S</b>
<b>Island Tops — No Backsplash</b>	
Stainless Steel Mobile WorkCenter Countertop — Single Island	<b>SXRCT2N23S</b>
Stainless Steel Mobile WorkCenter Countertop — Double Island	<b>SXRCT2N43S</b>
Stainless Steel Mobile WorkCenter Countertop — Triple Island	<b>SXRCT2N63S</b>
Stainless Steel Mobile WorkCenter Countertop — S-KW-S Island	<b>SXRCT2N73S</b>
<b>Tops with Backsplash and Overheads</b>	
Stainless Steel Mobile WorkCenter Countertop — Single Overhead	<b>SXRCT2U23S</b>
Stainless Steel Mobile WorkCenter Countertop — Double Overhead	<b>SXRCT2U43S</b>
Stainless Steel Mobile WorkCenter Countertop — Triple Overhead	<b>SXRCT2U63S</b>
Stainless Steel Mobile WorkCenter Countertop — S-KW-S Overhead	<b>SXRCT2U73S</b>

See pages 226-227 for Overhead Cabinet Selection

\*Base unit working height is equal to Base interior height +9" [229mm]  
(based on 5" [127mm] casters)  
Overhead exterior height is equal to Overhead interior height +2.5" [64mm]

Starsys Carts are built to exact customer specifications, therefore, they are non-cancelable, non-returnable.  
For Starsys pricing information, please contact your local Metro representative.

## Mobile WorkCenter Countertop Options (continued) Trespa® Phenolic Tops — Mobile WorkCenters

Description	Cat. No.
<b>Tops with Backsplash — No Overheads</b>	
Trespa Phenolic Mobile WorkCenter Countertop — Single Backsplash	SXRCT2B23T
Trespa Phenolic Mobile WorkCenter Countertop — Double Backsplash	SXRCT2B43T
Trespa Phenolic Mobile WorkCenter Countertop — Triple Backsplash	SXRCT2B63T
Trespa Phenolic Mobile WorkCenter Countertop — S-KW-S Backsplash	SXRCT2B73T
<b>Island Tops — No Backsplash</b>	
Trespa Phenolic Mobile WorkCenter Countertop — Single Island	SXRCT2N23T
Trespa Phenolic Mobile WorkCenter Countertop — Double Island	SXRCT2N43T
Trespa Phenolic Mobile WorkCenter Countertop — Triple Island	SXRCT2N63T
Trespa Phenolic Mobile WorkCenter Countertop — S-KW-S Island	SXRCT2N73T
<b>Tops with Backsplash and Overheads</b>	
Trespa Phenolic Mobile WorkCenter Countertop — Single Overhead	SXRCT2O23T
Trespa Phenolic Mobile WorkCenter Countertop — Double Overhead	SXRCT2O43T
Trespa Phenolic Mobile WorkCenter Countertop — Triple Overhead	SXRCT2O63T
Trespa Phenolic Mobile WorkCenter Countertop — S-KW-S Overhead	SXRCT2O73T
<b>Side Splash Options</b>	
Trespa Phenolic Mobile WorkCenter Countertop — Side Splash Backsplash	SXRCN2T
Trespa Phenolic Mobile WorkCenter Countertop — Side Splash Overhead	SXRCCS2T



Mobile WorkCenter with Trespa® Phenolic Top

## Corian® Tops — Mobile WorkCenters

Description	Size	Cat. No. Tarragon	Cat. No. Flint	Cat. No. Matterhorn	Cat. No. Stone Harbor	Cat. No. Silt
<b>Tops with Backsplash — No Overheads</b>						
Single	28.568x23.575	SXRCT3B23CTA	SXRCT3B23CFL	SXRCT3B23CMA	SXRCT3B23CSH	SXRCT3B23CSL
Double	28.568x43.375	SXRCT3B43CTA	SXRCT3B43CFL	SXRCT3B43CMA	SXRCT3B43CSH	SXRCT3B43CSL
Triple	28.568x63.175	SXRCT3B63CTA	SXRCT3B63CFL	SXRCT3B63CMA	SXRCT3B63CSH	SXRCT3B63CSL
Single-Kneewell-Single	28.568x73.075	SXRCT3B73CTA	SXRCT3B73CFL	SXRCT3B73CMA	SXRCT3B73CSH	SXRCT3B73CSL
<b>Island Tops — No Backsplash</b>						
Single	28.568x23.575	SXRCT3N23CTA	SXRCT3N23CFL	SXRCT3N23CMA	SXRCT3N23CSH	SXRCT3N23CSL
Double	28.568x43.375	SXRCT3N43CTA	SXRCT3N43CFL	SXRCT3N43CMA	SXRCT3N43CSH	SXRCT3N43CSL
Triple	28.568x63.175	SXRCT3N63CTA	SXRCT3N63CFL	SXRCT3N63CMA	SXRCT3N63CSH	SXRCT3N63CSL
Single-Kneewell-Single	28.568x73.075	SXRCT3N73CTA	SXRCT3N73CFL	SXRCT3N73CMA	SXRCT3N73CSH	SXRCT3N73CSL
<b>Tops with Backsplash and Overheads</b>						
Single	28.568x23.575	SXRCT3U23CTA	SXRCT3U23CFL	SXRCT3U23CMA	SXRCT3U23CSH	SXRCT3U23CSL
Double	28.568x43.375	SXRCT3U43CTA	SXRCT3U43CFL	SXRCT3U43CMA	SXRCT3U43CSH	SXRCT3U43CSL
Triple	28.568x63.175	SXRCT3U63CTA	SXRCT3U63CFL	SXRCT3U63CMA	SXRCT3U63CSH	SXRCT3U63CSL
Single-Kneewell-Single	28.568x73.075	SXRCT3U73CTA	SXRCT3U73CFL	SXRCT3U73CMA	SXRCT3U73CSH	SXRCT3U73CSL
<b>Side Splash Options</b>						
With Overhead Storage	3x25.063	SXRS3CTA	SXRS3CFL	SXRS3CMA	SXRS3CSH	SXRS3CSL
Without Overhead Storage	3x20.688	SXRN3CTA	SXRN3CFL	SXRN3CMA	SXRN3CSH	SXRN3CSL

\*Base unit working height is equal to Base interior height +9" [229mm] (based on 5" [127mm] casters) Overhead exterior height is equal to Overhead interior height +2.5" [64mm]

## Kneewell Options

Description	Cat. No.
<b>30" (762mm) Kneewell</b>	
30" (762mm) Brkt Assembly Keyboard Tray	SXR30BRKTKB-MW
30" (762mm) Brkt Assembly Blank	SXR30BRKT-MW
30" (762mm) Brkt Assembly Pencil Drawer	SXR30BRKTPN-MW
<b>42" (1067mm) Kneewell</b>	
42" (1067mm) Brkt Assembly Keyboard Tray, Mobile WorkCenter	SXR42BRKTKB-MW
42" (1067mm) Brkt Assembly Blank, Mobile WorkCenter	SXR42BRKT-MW
42" (1067mm) Brkt Assembly Pencil Drawer, Mobile WorkCenter	SXR42BRKTPN-MW

### Solid Surface Colors



To configure a Starsys unit to your exact specifications, please visit [www.metroconfigurator.com](http://www.metroconfigurator.com)



**Mobile WorkCenter Overhead Cabinet Support**  
Select overhead cabinets on pages 226 and 227.

Description	Cat. No.
<b>Lateral Supports for Overhead Cabinets — Select one per WorkCenter</b>	
Overhead Structure Single Wide Mobile WorkCenter	SXRSMWOHB
Overhead Structure Double Wide Mobile WorkCenter	SXRDMWOHB
Overhead Structure Triple Wide Mobile WorkCenter	SXRTMWOHB
Overhead Structure Single-Kneewell Mobile WorkCenter	SXRKMWOHB

<b>Vertical Supports for Overhead Cabinets — Select one pair per WorkCenter</b>	
24" (610mm) Base Interior with 24" (610mm) Overhead Interior (1 Pair)	SXRMWUP24-24
24" (610mm) Base Interior with 27" (686mm) Overhead Interior (1 Pair)	SXRMWUP24-27
24" (610mm) Base Interior with 30" (762mm) Overhead Interior (1 Pair)	SXRMWUP24-30
24" (610mm) Base Interior with 33" (838mm) Overhead Interior (1 Pair)	SXRMWUP24-33
27" (686mm) Base Interior with 24" (610mm) Overhead Interior (1 Pair)	SXRMWUP27-24
27" (686mm) Base Interior with 27" (686mm) Overhead Interior (1 Pair)	SXRMWUP27-27
27" (686mm) Base Interior with 30" (762mm) Overhead Interior (1 Pair)	SXRMWUP27-30
30" (762mm) Base Interior with 24" (610mm) Overhead Interior (1 Pair)	SXRMWUP30-24
30" (762mm) Base Interior with 27" (686mm) Overhead Interior (1 Pair)	SXRMWUP30-27
33" (838mm) Base Interior with 24" (610mm) Overhead Interior (1 Pair)	SXRMWUP33-24

<b>Overhead Cabinet and Shelving Combination — Vertical Supports</b>	
24" (610mm) Base 24" (610mm) Overhead Interior and Slotted Inserts	SXRMWUP24Q-24
24" (610mm) Base 27" (686mm) Overhead Interior and Slotted Inserts	SXRMWUP24Q-27
24" (610mm) Base 30" (762mm) Overhead Interior and Slotted Inserts	SXRMWUP24Q-30
24" (610mm) Base 33" (838mm) Overhead Interior and Slotted Inserts	SXRMWUP24Q-33
27" (686mm) Base 24" (610mm) Overhead Interior and Slotted Inserts	SXRMWUP27Q-24
27" (686mm) Base 27" (686mm) Overhead Interior and Slotted Inserts	SXRMWUP27Q-27
27" (686mm) Base 30" (762mm) Overhead Interior and Slotted Inserts	SXRMWUP27Q-30
30" (762mm) Base 24" (610mm) Overhead Interior and Slotted Inserts	SXRMWUP30Q-24
30" (762mm) Base 27" (686mm) Overhead Interior and Slotted Inserts	SXRMWUP30Q-27
33" (838mm) Base 24" (610mm) Overhead Interior and Slotted Inserts	SXRMWUP33Q-24



**Mobile WorkCenter Reagent Shelving and Supports**

Description	Cat. No.
<b>Reagent Shelving Options</b>	
Shelf Assembly — Single width	SXRSMWSHF
Shelf Assembly — Double width	SXRDMWSHF
Shelf Assembly — Triple width	SXRTMWSHF
Shelf Assembly — Single-Kneewell — Single	SXRKMWSHF

<b>Lateral Support for Reagent Shelving — Select one per WorkCenter</b>	
Cross Member — Single width	SXRSMWSB
Cross Member — Double width	SXRDMWSB
Cross Member — Triple width	SXRTMWSB
Cross Member — Single-Kneewell — Single	SXRKMWSB

<b>Vertical Supports with Slotted Inserts for Reagent Shelving — Select one pair per WorkCenter</b>	
24" (610mm) Base Interior with Slotted Inserts (1 Pair)	SXRMWUP24Q
27" (686mm) Base Interior with Slotted Inserts (1 Pair)	SXRMWUP27Q
30" (762mm) Base Interior with Slotted Inserts (1 Pair)	SXRMWUP30Q
33" (838mm) Base Interior with Slotted Inserts (1 Pair)	SXRMWUP33Q

\*Base unit working height is equal to Base interior height +9" [229mm] (based on 5" [127mm] casters) Overhead exterior height is equal to Overhead interior height +2.5" [64mm]

Starsys Carts are built to exact customer specifications, therefore, they are non-cancelable, non-returnable.  
For Starsys pricing information, please contact your local Metro representative.

## Solutions That Move You. Mobile, Modular, Metro.



### Starsys Stationary WorkCenters

Starsys WorkCenters are designed to be a fully integrated, fully adaptable, modular system. WorkCenters can be stand alone products or can be a configured section within a larger product configuration. WorkCenters combine valuable lower storage areas with finished modular countertops to offer a complete storage and work area solution. Starsys WorkCenters are made up of two key components: base units and countertops. Understanding how these two elements work together is the key to understanding the Starsys WorkCenters line. While sections of Starsys WorkCenters can be configured into many physical combinations, these sections are typically divided into two categories: “straight run” or “corner” configurations.

**Working Heights:** Starsys WorkCenters are available in the following working heights: 30" (762mm), 33" (838mm), 36" (914mm), 39" (990mm) and 42" (1067mm). Within each working height there is up to 2.5" (64mm) of additional height adjustment via the four adjustable leveling feet in each base unit.

### Starsys Base Units

Base units are the products that provide valuable lower storage areas, as well as providing the necessary support for countertops. Base units are the most critical part of a configuration with countertops. Their total combined length and placement will determine the length of the associated countertops in the design. Their placement will determine the placement and size of necessary kneewells and provide support for valuable corner work areas. All Starsys base units are available in light taupe but have the flexibility to be accented with various door & drawer handle colors. Countertop color selection and cove base color selections may be used to accent the base unit color.

- Microban® antimicrobial product protection inhibits the growth of mold, mildew, and bacteria keeping the surface area “cleaner between cleanings.”

**System Widths:** Base Units are available in Single and Double widths.

**System Heights:** Base Units are designed to work with the following nominal countertop heights: 30" (762mm), 33" (838mm), 36" (914mm), 39" (990mm) & 42" (1067mm)

To configure a Starsys unit to your exact specifications, please visit [www.metroconfigurator.com](http://www.metroconfigurator.com)

For specification details, consult page 221

Preconfigured WorkCenter Base Units



Cat. No. **SXRS30BU1**



Cat. No. **SXRS30BU2**



Cat. No. **SXRS30BU3**



Cat. No. **SXRS30BU4**



Cat. No. **SXRS30BUHD1**



Cat. No. **SXRD30BU1**



Cat. No. **SXRD30BU2**



Cat. No. **SXRD30BUHD1**



Cat. No. **SXRD30BUHD2**



Cat. No. **SXRS36BU1**



Cat. No. **SXRS36BU2**



Cat. No. **SXRS36BU3**



Cat. No. **SXRS36BU4**



Cat. No. **SXRS36BU6**



Cat. No. **SXRS36BUHD1**



Cat. No. **SXRS36BUHD2**



Cat. No. **SXRD36BU1**



Cat. No. **SXRD36BU2**

Starsys Carts are built to exact customer specifications, therefore, they are non-cancelable, non-returnable.  
For Starsys pricing information, please contact your local Metro representative.

Preconfigured WorkCenter Base Units



Cat. No. SXR36BU3



Cat. No. SXR36BU4



Cat. No. SXR36BU6



Cat. No. SXR36BUHD2



Cat. No. SXR39BU1



Cat. No. SXR39BU3



Cat. No. SXR39BU4



Cat. No. SXR39BU6



Cat. No. SXR39BUHD1



Cat. No. SXR39BUHD2

To configure a Starsys unit to your exact specifications, please visit [www.metroconfigurator.com](http://www.metroconfigurator.com)

For specification details, consult page 221



Valance Kit



30° Kneewell Bracket with Pencil Drawer Option

**Countertop Support Brackets:**

The counter-to-counter bracket allows a countertop adjacent to a WorkCenter section with base unit to be supported at the same working height without the need for an additional base unit. The offset counter bracket allows for similar configurations but accommodates change in the working heights by dropping the adjacent countertop by 3", 6", or 9" (76, 152, or 229mm) as required by the application.

**Base Unit Trim Kits**

Description	Cat. No.
<b>Back Wall Trim Kits — 25" Deep Countertops</b>	
Back Wall Trim Kit x 39 (all heights)	SXR39BKFLR
<b>Back-to-Back Cabinet Trim Kits — 25" Deep Countertops</b>	
Back to Back Filler for 30" H — 25" Countertop	SXR30BBFLR
Back to Back Filler for 33" H — 25" Countertop	SXR33BBFLR
Back to Back Filler for 36" H — 25" Countertop	SXR36BBFLR
Back to Back Filler for 39" H — 25" Countertop	SXR39BBFLR
Back to Back Filler for 42" H — 25" Countertop	SXR42BBFLR
<b>Back Wall Trim Kits — 30" Deep Countertops</b>	
Back Wall Trim for 30" H — 30" Countertop	SXR30BKFLR30
Back Wall Trim for 33" H — 30" Countertop	SXR33BKFLR30
Back Wall Trim for 36" H — 30" Countertop	SXR36BKFLR30
Back Wall Trim for 39" H — 30" Countertop	SXR39BKFLR30
Back Wall Trim for 42" H — 30" Countertop	SXR42BKFLR30
<b>Back-to-Back Cabinet Trim Kits — 30" Deep Countertops</b>	
Back to Back Filler for 30" H — 30" Countertop	SXR30BBFLR30
Back to Back Filler for 33" H — 30" Countertop	SXR33BBFLR30
Back to Back Filler for 36" H — 30" Countertop	SXR36BBFLR30
Back to Back Filler for 39" H — 30" Countertop	SXR39BBFLR30
Back to Back Filler for 42" H — 30" Countertop	SXR42BBFLR30
<b>Unit-to-Unit Filler Kits</b>	
Unit to Unit Filler Strip Kit (10 pieces/kit)	SXR72UUFLR
<b>Corner Filler Kits</b>	
45 Degree Corner Filler Strip Kit x 84	SXR84CR45FLR
90 Degree Corner Filler Strip Kit x 84	SXR84CR90FLR

**WorkCenter Base Unit Accessories**

Description	Cat. No.
<b>Kneewell Options and Accessories</b>	
Undercounter Keyboard Tray	SXRKYBDTRY
30 Brkt Assembly Blank	SXR30BRKT
30 Brkt Assembly Keyboard Tray	SXR30BRKTKB
30 Brkt Assembly Pencil Drawer	SXR30BRKTPN
42 Brkt Assembly Blank	SXR42BRKT
42 Brkt Assembly Keyboard Tray	SXR42BRKTKB
42 Brkt Assembly Pencil Drawer	SXR42BRKTPN
<b>Sink Valance</b>	
Sink Valance Kit	SXRSINKVLC
<b>Floor Mounting Kit</b>	
Floor Mounting Kit	SXR-FLR

**Countertop Accessories**

Description	Cat. No.
<b>Countertop Mounting Brackets</b>	
Counter to Counter Bracket	SXRCCBRKT
Counter to Wall Bracket	SXRCWBRKT
Offset Counter Bracket — 3	SXROST3BRKT
Offset Counter Bracket — 6	SXROST6BRKT
Offset Counter Bracket — 9	SXROST9BRKT
<b>Countertop Hole Grommet Kits</b>	
Hole Grommet Kit	SXRHOLEGRMT

Starsys Carts are built to exact customer specifications, therefore, they are non-cancelable, non-returnable.

For Starsys pricing information, please contact your local Metro representative.



Starsys™ WorkCenters — Sinks, Fixtures and Eye Washes — 8.01

Below is a sampling of the wide variety of single- and double-bay sinks, faucets, eye washes and other fixtures available with countertop units: black epoxy sinks, stainless steel sinks (lipped or undermount), standard and laboratory grade faucets (deck or floor mount). Pure water and pre-rinse faucets also available. Consult your Metro representative.



**Stainless Steel Sink and Faucet Kit**  
Includes 12" x 12" x 7½" (305 x 305 x 191mm) stainless steel sink bowl, chrome-plated faucet (6" [152mm] swivel gooseneck wrist blade handles), trap and drain.  
**Cat. No. SC0459**



**Laboratory Mixing Faucet**  
Deck mounted, 6" (152mm) swing vacuum breaker, 10 serration hose end gooseneck, four arm handles.  
**Cat No. SC0734A**



**Stainless Steel Sink and Faucet Kit**  
Includes 14" x 18" x 7½" (356 x 457 x 191mm) stainless steel sink bowl, chrome-plated faucet (6" [152mm] swivel gooseneck wrist blade handles) trap and drain.  
**Cat. No. SC0460**



**Laboratory Mixing Faucet**  
Deck mounted, 6" (152mm) swing vacuum breaker gooseneck, 10 serration hose end and four arm handles.  
**Cat No. SCP1830Q**



**Black Epoxy-Lipped Sink Bowl**  
Includes 16" x 12" x 8" (406 x 305 x 203mm) bowl, center outlet and strainer.  
**Cat. No. SCP1148F**



**Eye Wash (Rear Mount)**  
Polished chrome plated brass, right-hand deck mount AutoFlow™ GS-Plus™ spray heads 90° swing-down flip-top spray head dust covers.  
**Cat. No. SCP0734C**



**Black Epoxy Lipped Sink Bowl**  
Includes 25" x 15" x 10" (635 x 381 x 254mm) bowl, corner outlet and strainer.  
**Cat. No. SCP1320B**



**Eye Wash (Right-Side Mount)**  
12.5" (318mm) swing away arm with swivel valve, right side deck mount, acetal dual stream heads with integral hinged covers.  
**Cat No. SCP11771**

To configure a Starsys unit to your exact specifications, please visit [www.metroconfigurator.com](http://www.metroconfigurator.com)

## Solutions That Move You. Mobile, Modular, Metro.



Starsys Overhead Storage Solutions: The Starsys line offers two solutions when additional wall storage is required above a WorkCenter or when overhead storage is required above a Mobile WorkCenter.

Starsys Half-Depth Overhead Storage Units — are built on the same widths as Starsys base units utilizing very similar construction, insuring that wall cabinets align with the lower product configuration in your application. Starsys Overhead Cabinets are available as single or double width cabinets in the following interior heights:

Interior dimensions: 24", 27", 30", 33", 36" [610mm, 686mm, 762mm, 838mm, 914mm] (add 2.5" [64mm] for overall exterior height).

All Starsys overhead cabinets include corrugated polymer inner panels in their assembly as well as a clean-design back panel, molded with the cosmetic side facing the inside of cabinet, creating a much cleaner appearance — especially when used without doors or in conjunction with a clear door. The necessary wall mount rails/hardware are included with each wall cabinet. (wall anchoring hardware is not supplied by InterMetro).

Starsys Carts are built to exact customer specifications, therefore, they are non-cancelable, non-returnable.  
For Starsys pricing information, please contact your local Metro representative.



Cat. No. SXR5OH27P2C



Cat. No. SXR5OH27P2N



Cat. No. SXR5OH27P2S



Cat. No. SXRDOH27P2S



Cat. No. SXRDOH27W2C

### Starsys Wall Cabinet Accessories

Description	Cat. No.
<b>Wall Cabinet Shelving</b>	
Single-wide Overhead Polymer Shelf	SXR5OHPS
Single-wide Overhead Wire Shelf	SXR5OHWE
Double-wide Overhead Polymer Shelf	SXRDOHPS
Double-wide Overhead Wire Shelf	SXRDOHWE
<b>Wall Cabinet Shelf Divider Kits</b>	
Single-wide Overhead Shelf Divider Kit	SXR5OHDIV
Double-wide Overhead Shelf Divider Kit	SXRDOHDIV
<b>Under Cabinet Lighting</b>	
Single-wide Overhead Light (Valance and 1 Light)	SXR5OHL
Double-wide Overhead Light (Valance and 1 Light)	SXRDOHL
Triple-wide Overhead Light (Valance and 2 Lights)	SXRTOHL
Additional Overhead Light	SXROHLT
<b>Cassettes and Bins</b>	
1 Level Cassette Body	SXRCASB1
2 Level Cassette Body	SXRCASB2
3 Level Cassette Body	SXRCASB3
4 Level Cassette Body	SXRCASB4
5 Level Cassette Body	SXRCASB5
3" (76mm) wide Cassette Bin	SXRBINSB3
4 1/2" (114mm) wide Cassette Bin	SXRBINSB4
6" (152mm) wide Cassette Bin	SXRBINSB6
8" (203mm) wide Cassette Bin	SXRBINSB8
<b>Note:</b> Bins are shipped with one ID card.	
<b>Sloped Tops — Wall Cabinets</b>	
Single-wide Overhead Sloped Top	SXR5OHLTOP
Double-wide Overhead Sloped Top	SXRDOHSLTOP
<b>Filler Kits — Additional Wall Mount Rails and Covers</b>	
49" (1245mm) Overhead Back Filler Kit	SXROHFLR-49
63" (1600mm) Mounting Rail Cover Kit	SXROHFLR-63
Additional Single-wide Wall Mount Bracket Kit (1 Pair)	SXROHWB-22
Additional Double-wide Wall Mount Bracket Kit (1 Pair)	SXROHWB-42



Wall Cabinets

To configure a Starsys unit to your exact specifications, please visit [www.metroconfigurator.com](http://www.metroconfigurator.com)

### Standard Terms and Conditions of Sale

These Terms and Conditions, the attendant quotation or acknowledgment and all documents incorporated by specific reference therein, will be the complete and exclusive statement of the terms of the agreement governing the sale of goods ("Goods") by InterMetro Industries Corporation and its divisions ("Seller") to Customer ("Buyer"). Buyer's acceptance of the goods will manifest buyer's assent to these terms and conditions. If these terms and conditions differ in any way from the terms and conditions of buyer's order, or other documentation, this document will be construed as a counteroffer and will not be deemed an acceptance of buyer's terms and conditions which conflict herewith.

#### 1. Prices:

Unless otherwise specified in writing by Seller, Seller's price for the goods shall remain in effect for thirty (30) days after the date of Seller's quotation or acknowledgment of Buyer's order for the Goods, whichever occurs first, provided an unconditional, complete authorization for the immediate shipment of the Goods is received and accepted by Seller within such time period. If such authorization is not received by Seller within such thirty (30) day period, Seller shall have the right to change the price for the Goods to Seller's price for the Goods at the time of shipment.

#### 2. Taxes:

Any tax or governmental charge or increase in same hereafter becoming effective increasing the cost to Seller of producing, selling or delivering the Goods or of procuring material used therein, and any tax now in effect or increase in same payable by the Seller because of the manufacture, sale or delivery of the Goods, may at Seller's option, be added to the price.

#### 3. Terms and Payment:

Subject to the approval of Seller's Credit Department, terms are 1% ten (10) days net thirty (30) days from date of Seller's invoice in U.S. currency. Freight and handling charges are not subject to discount. If any payment owed to Seller is not paid when due, it shall bear interest at a rate to be determined by Seller, which shall not exceed the maximum rate permitted by law, from the date on which it is due until it is paid. Seller shall have the right among other remedies, either to terminate the Agreement or to suspend further performance under this and/or other agreements with Buyer in the event Buyer fails to make any payment when due. Buyer shall be liable for all expenses, including attorneys' fees, relating to the collection of past due amounts.

#### Minimum Order:

Orders under \$250.00 net, routed prepaid via small package carriers (UPS and FedEx), will be charged \$39.00 freight and handling. Orders under \$250.00 net, routed air freight, LTL, third party, or collect, will be charged a handling fee of \$29.00 plus actual freight costs when applicable. (All amounts in U.S. currency.)

#### Returns:

Written approval is required from the factory to return merchandise. All merchandise must be returned within 45 days from the invoice date and be returned in original, unopened, and resalable packaging.

1. Minimum return value — \$200.00 net.
2. Restocking charge — 15% (\$50.00 minimum).
3. Exceptions — Special orders of cut posts, made to order dollies, cart covers, Designer Color product, Starsys, and custom are not returnable. (All amounts in U.S. currency.)

#### 4. Shipment and Delivery:

Shipments are made FOB Seller's shipping point. We reserve the right to split orders based on the FOB Shipping Point. Order consolidation is available for an additional charge. Contact customer service for more information. Any claims for shortages or damages suffered in transit shall be submitted by the Buyer directly to the carrier. While Seller will use all reasonable commercial efforts to maintain the delivery date acknowledged or quoted by Seller, all shipping dates are approximate. Seller reserves the right to make partial shipments and to segregate "specials" and made-to-order Goods from normal stock Goods. Seller shall not be bound to tender delivery of any Goods for which Buyer has not provided shipping instructions.

#### 5. Limited Warranty:

Subject to the limitations of Section 1, Seller warrants that the Goods will be free from defects in material and workmanship under normal use, service and maintenance for a period of one year (unless otherwise specified by Seller in writing) from the date of shipment of the Goods by Seller. THIS IS THE SOLE AND EXCLUSIVE WARRANTY GIVEN BY SELLER WITH RESPECT TO THE GOODS AND IS IN LIEU OF AND EXCLUDES ALL OTHER WARRANTIES, EXPRESS OR IMPLIED, ARISING BY OPERATION OF LAW OR OTHERWISE, INCLUDING WITHOUT LIMITATION, MERCHANTABILITY OR FITNESS FOR A PARTICULAR PURPOSE WHETHER OR NOT THE PURPOSE OR USE HAS BEEN DISCLOSED TO SELLER IN SPECIFICATIONS, DRAWINGS OR OTHERWISE, AND WHETHER OR NOT SELLER'S PRODUCTS ARE SPECIFICALLY DESIGNED AND/OR MANUFACTURED BY SELLER FOR BUYER'S USE OR PURPOSE.

This warranty does not extend to any losses or damages due to misuse, accident, abuse, neglect, normal wear and tear, unauthorized modification or alteration, use beyond rated capacity, or improper installation, maintenance or application. To the extent that Buyer or its agents has supplied specifications, information, representation of operating conditions or other data to Seller in the selection or design of the Goods and the preparation of Seller's quotation, and in the event that actual operating conditions or other conditions differ from those represented by Buyer, any warranties or other provisions contained herein which are affected by such conditions shall be null and void. If within thirty (30) days after Buyer's discovery of any warranty defects within the warranty period, Buyer notifies Seller thereof in writing, Seller shall, at its option, repair or replace F.O.B. point of manufacture, or refund the purchase price for, that portion of the goods found by Seller to be defective. Failure by Buyer to give such written notice within the applicable time period shall be deemed an absolute and unconditional waiver of Buyer's claim for such defects. Goods

repaired or replaced during the warranty period shall be covered by the foregoing warranty for the remainder of the original warranty period or ninety (90) days, whichever is longer. Buyer assumes all other responsibility for any loss, damage, or injury to persons or property arising out of, connected with, or resulting from the use of Goods, either alone or in combination with other products/components.

- (a) Notification and Warranty Procedure. If, in Customer's estimation, the Product is defective, Customer shall promptly notify Seller in writing of the nature of the defect, or shall notify Seller of the nature of the defect through Seller's Customer Service offices via telephone at 800.992.1776 or as specified at [www.metro.com](http://www.metro.com). If Seller determines the Product is covered under the warranties provided in this Sections 5 and 6, Seller will promptly provide a return authorization number and communicate shipping instructions to Customer. Products will be returned to Seller at Customer's expense. Collect shipments will not be accepted. Upon receipt, the Product will be examined and repaired without charge, provided such examination discloses, in Seller's reasonable judgment, that it is in fact defective. Should examination reveal that the Product is not defective, Seller will notify Customer and request shipping instructions. In this event, Seller will be due all shipping expenses it has incurred, as well as a reasonable charge for the examination. In the event that the examination reveals that the Product is defective, but for any reason is not covered under the warranties provided in Sections 5 and 6, Seller will prepare a failure analysis report and a quotation of the cost to repair, and communicate this information to Customer. Customer may then either authorize repair of the Product or direct that the defective Product be returned to Customer. In the latter event, Seller will be due all shipping charges incurred, as well as a reasonable charge for the examination of the Product and the preparation of the failure analysis report. Seller may, at its option, elect to correct any warranty defects by sending its supervisory or technical representatives, at Seller's expense, to Customer's site within the continental United States or Canada to make on-site corrections. The repair of Products damaged in transit to Seller's designated service location will be billed on a T&M basis at Seller's then-current rates. For Product that proves to be defective and covered under the warranties provided in Sections 5 and 6, Seller will repair or replace and ship, via two-day express delivery service. Services provided hereunder on a T&M basis are warranted by Seller under the warranty terms of Sections 5 and 6 for a period of 30 days from the date such Services are provided. For Product that proves to be defective within 30 days from the time of delivery, Seller will ship to Customer at Seller's expense replacement Equipment (Advanced Exchange) upon Customer's request. Seller has the option to repair or replace the defective Equipment with Equipment of equal or similar features

and/or functionality. Upon Seller's receipt of the Equipment; the Equipment will be examined and repaired without additional charge. Any Equipment received by Seller from Customer will become the property of Seller and any Equipment shipped to Customer by Seller under this provision shall become the property of Customer. Should Seller's examination of returned Equipment disclose, in Seller's reasonable judgment, that it is in fact defective; no further action under the claim will be required of Seller or Customer. Should Seller's examination reveal, in Seller's reasonable judgment, that the Equipment is not defective, or in the event that the examination reveals that the Equipment is defective, but for any reason is not covered under the warranties provided in Sections 5 and 6, Seller will prepare a failure analysis report and a quotation for the cost to repair, or replacement and communicate this information to Customer.

SECTIONS 5 AND 6 APPLY TO ANY ENTITY OR PERSON WHO MAY BUY, ACQUIRE OR USE SELLER'S GOODS, INCLUDING ANY ENTITY OR PERSON WHO BUYS THE GOODS FROM SELLER'S DISTRIBUTOR AND SUCH ENTITY OR PERSON SHALL BE BOUND BY THE LIMITATIONS THEREIN.

- (b) For Product that has been installed by Seller or Seller authorized service providers as part of a system for which Seller has acknowledged interoperability responsibility in writing, Seller will provide telephone technical support services in accordance with Seller's standard procedures for 60 days beginning on the Warranty Start Date for such Products. Products sold as add-on equipment to a system are not covered by this technical support warranty.
- (c) Batteries and Accessories. All batteries and accessory items, sold by Seller to Customer hereunder receive the Product warranty under Sections 5 and 6 with a Warranty Period of one year from the Warranty Start Date. Battery adjustments will be prorated over a one year period.
- (b) Software: Seller has no obligation under the warranties provided in Sections 5 and 6 to correct any Licensed Software programming error(s) that do not significantly adversely affect the use of the Products; however, such programming error corrections shall be made available from time to time to those Customers electing applicable contract maintenance services from the Seller.

**6. Limitation of Remedy and Liability:**  
THE SOLE AND EXCLUSIVE REMEDY FOR BREACH OF ANY WARRANTY HEREUNDER (OTHER THAN THE WARRANTY PROVIDED UNDER SECTION 13) SHALL BE LIMITED TO REPAIR, REPLACEMENT OR REFUND OF THE PURCHASE PRICE UNDER SECTION 6. SELLER SHALL NOT BE LIABLE FOR DAMAGES CAUSED BY DELAY IN PERFORMANCE AND IN NO EVENT, REGARDLESS OF THE FORM OF THE CLAIM OR CAUSE OF ACTION (WHETHER BASED IN CONTRACT, INFRINGEMENT, NEGLIGENCE, STRICT LIABILITY, OTHER TORT OR OTHERWISE), SHALL SELLER'S LIABILITY TO BUYER AND/ OR ITS CUSTOMERS EXCEED

THE PRICE TO BUYER OF THE SPECIFIC GOODS PROVIDED BY SELLER GIVING RISE TO THE CLAIM OR CAUSE OF ACTION. BUYER AGREES THAT IN NO EVENT SHALL SELLER'S LIABILITY TO BUYER AND/OR ITS CUSTOMERS EXTEND TO INCLUDE INCIDENTAL, CONSEQUENTIAL OR PUNITIVE DAMAGES. THE TERM

"CONSEQUENTIAL DAMAGES" SHALL INCLUDE, BUT NOT BE LIMITED TO, LOSS OF ANTICIPATED PROFITS, LOSS OF USE, LOSS OF REVENUE, COST OF CAPITAL AND DAMAGE OR LOSS OF OTHER PROPERTY OR EQUIPMENT.

It is expressly understood that any technical advice furnished by Seller with respect to the use of the Goods is given without charge, and Seller assumes no obligation or liability for the advice given, or resumes obtained, all such advice being given and accepted at Buyer's risk.

**7. Excuse of Performance:**  
Seller shall not be liable for delays in performance or for non-performance due to acts of God, acts of Buyer, war, riot, fire, flood, power surges, other severe weather, sabotage, or epidemics; strikes or labor disturbances; governmental requests, restrictions, laws, regulations, orders or actions; unavailability of or delays in transportation; default of suppliers; or unforeseen circumstances or any events or causes beyond Seller's reasonable control. Deliveries may be suspended for an appropriate period of time as a result of the foregoing. If Seller determines that its ability to supply the total demand for the Goods is hindered, limited or made impracticable due to causes addressed in this Section 7, Seller may allocate its available supply of the Goods or such material (without obligation to acquire other supplies of any such Goods or such materials) among itself and its purchasers on such basis as Seller determines to be equitable without liability for any failure of performance which may result therefrom. Deliveries suspended or not made by reason of this section may be canceled by Seller upon notice to Buyer without liability, but the balance of the agreement shall otherwise remain unaffected.

**8. Cancellation:**  
The Buyer may cancel orders only upon written notice and upon payment to Seller of cancellation or restocking charges which include, among other things, all costs and expenses incurred and commitments made by the Seller and a reasonable profit thereon. Large requirements of build-to order products may require a non-cancelable purchase order.

**9. Changes:**  
Buyer may request changes or additions to the Goods consistent with Seller's specifications and criteria. In the event such changes or additions are accepted by Seller, Seller may revise the price and delivery schedule. Seller reserves the right to change designs and specifications for the Goods without prior notice to Buyer, except with respect to Goods being made-to-order for Buyer.

**10. Tooling:**  
Tool, die, and pattern charges, if any, are in addition to the price of the Goods and are due and payable upon completion of the tooling. All such tools, dies and patterns shall be and remain the property of Seller. Charges for tools,

dies, and patterns do not convey to Buyer, title, ownership interests in, or rights to possession or removal, nor prevent their use by Seller for other purchasers, except as otherwise expressly provided by Seller and Buyer in writing with reference to this provision.

**11. Assignment:**  
Buyer shall not assign its rights or delegate its duties hereunder or any interest therein or any rights hereunder without the prior written consent of the Seller, and any such assignment, without such consent, shall be void.

**12. Patents and Copyrights:**  
Subject to Section 7, Seller warrants that the Goods sold, except as are made specifically for Buyer according to Buyer's specifications, do not infringe any valid U.S. patent or copyright in existence as of the date of delivery. This warranty is given upon the condition that Buyer promptly notify Seller of any claim or suit involving Buyer in which such infringement is alleged, and, that Buyer cooperate fully with Seller and permit Seller to control completely the defense or compromise of any such allegation of infringement. Seller's warranty as to use only applies to infringements arising solely out of the inherent operation (1) of such Goods, or (2) of any combination of Goods in a system designed by Seller. In the event such Goods, singularly or in combination, are held to infringe a U.S. patent or copyright in such suit, and the use of such Goods is enjoined, or in the case of a compromise by Seller, Seller shall have the right at its option and expense, to procure for Buyer the right to continue using such Goods, or replace them with non-infringing Goods; or modify same to become non-infringing; or grant Buyer a credit for the depreciated value of such Goods and accept return of them.

**13. General Provisions:**  
These terms and conditions supersede all other communications, negotiations and prior oral or written statements regarding the subject matter of these terms and conditions. No change, modification, rescission, discharge, abandonment or waiver of these terms and conditions shall be binding upon the Seller unless made in writing and signed on its behalf by a duly authorized representative of Seller. No conditions, usage of trade, course of dealing or performance, understanding or agreement purporting to modify, vary, explain, or supplement these terms and conditions shall be binding unless hereafter made in writing and signed by the party to be bound, and no modification or additional terms shall be applicable to this agreement by Seller's receipt, acknowledgment, or acceptance of purchase orders, shipping instruction forms, or other documentation containing terms at variance with or in addition to those set forth herein. Any such modifications or additional terms are specifically rejected by Seller. No waiver by either party with respect to any breach or default or of any right or remedy, and no course of dealing, shall be deemed to constitute a continuing waiver of any other breach or default or of any other right or remedy, unless such waiver be expressed in writing and signed by the party to be bound. All typographical or clerical errors made by Seller in any quotation, acknowledgment or publication are subject to correction.



The validity, performance, and all other matters relating to the interpretation and effect of this agreement shall be governed by the law of the state of Pennsylvania. Buyer and Seller agree that the proper venue for all actions arising in connection herewith shall be only in Pennsylvania and the parties agree to submit to such jurisdiction. No action, regardless of form, arising out of transactions relating to this contract, may be brought by either party more than two (2) years after the cause of action has accrued. [The Convention for the International Sales of Goods shall not apply to this agreement.]

Buyer agrees that all applicable import, export control and sanctions laws, regulations, orders and requirements, as they may be amended from time to time, including without limitation those of the United States, the European Union and the jurisdictions in which Seller and Buyer are established or from which items may be supplied, and the requirements of any licenses, authorizations, general licenses or license exceptions relating thereto will apply to its receipt and use of hardware, software, services and technology. Buyer agrees furthermore that it shall not engage in any activity that would expose Seller or any of its affiliates to a risk of penalties under laws and regulations of any relevant jurisdiction prohibiting improper payments, including but not limited to bribes, to officials of any government or of any agency, instrumentality or political subdivision thereof, to political parties or political party officials or candidates for public office, or to any employee of any customer or supplier. Buyer agrees to comply with all appropriate legal, ethical and compliance requirements.

**Configured Products\***

**Terms & Conditions and Order Change/ Cancellation Policy**

All order change requests must be requested through customer service. Changes/cancellations requested within 7 workdays of the scheduled ship date that will impact order production, will incur, at minimum, a 20% Change/Cancellation Fee, up to the full order value, depending on the percentage of the order completed. Customer service will relay percentage of order completed along with the Change/ Cancellation Fee amount. Prior to Metro accepting the change, a revised purchase order (including associated Fee) is required. Orders for C5 cabinets with an "A" suffix are non-cancellable and non-returnable.

**Configured Products Return Policy.**

- Configured units, components, countertops, Lionville Fixtures, assembled Open Starsys, Flo and Lionville Point of Care carts and custom items are nonreturnable.
- Med Dispense units, Lionville Med Carts, and accessories are returnable at the discretion of Metro.
  - A Return Merchandise Authorization (RMA) must be obtained through InterMetro's customer service department prior to returning the product.
  - All returns will be coordinated by InterMetro and return freight costs will be charged back.
  - All returns must be in original packaging, unused and in saleable condition.

**Starsys Order Change/Cancellation Policy**

All order change requests must be requested through customer service. Changes/ cancellations requested within 7 workdays of the scheduled ship date that will impact order production, will incur, at minimum, a 20% Change/Cancellation Fee, up to the full order value, depending on the percentage of the order completed. Customer service will relay percentage of order completed along with the Change/Cancellation Fee amount. Prior to Metro accepting the change, a revised purchase order (including associated Fee) is required.

**Lead Time:**

Orders for Standard Starsys products ship within 4-6 weeks after receipt of Purchase Order and Signed Drawings. Custom Starsys product is acknowledged to order. Shipping: All Starsys Orders ship FOB: Wilkes-Barre, PA — InterMetro Industries utilizes air-ride carriers exclusively when shipping the Starsys product system domestically. In the case of customer arranged freight, the use of air-ride carriers is strongly recommended. InterMetro Industries is not responsible for freight damage incurred on customer arranged transportation.

**Starsys Return Policy**

- Starsys units, components, countertops, assembled Open Starsys and custom items are nonreturnable.
- Accessories are returnable at the discretion of Metro.
  - A Return Merchandise Authorization (RMA) must be obtained through InterMetro's customer service department prior to returning the product.
  - All returns will be coordinated by InterMetro and return freight costs will be charged back.
  - All returns must be in original packaging, unused and in saleable condition.
  - All returns must be made within 45 days of invoice date.
  - Minimum return value is \$100.00 net.
  - There will be a 20% Restocking Fee (\$25.00 minimum) based on items credited after an inspection is performed on the product at the Wilkes-Barre, PA distribution facility.

*\*Configured products apply to C5 Heated Cabinets, Lifeline, Flexline, Starsys, MetroBasix Pus, MetroBasix, MetroBasix Compact, Flo and Lionville Point of Care Carts, Lionville Fixtures and Lionville i-Med carts.*

*\*\*Those Terms and Conditions provided expressly for Starsys products supersede those stated for all other Metro product. Those situations not specifically addressed by Starsys Terms and Conditions are covered by Metro's standard Terms and Conditions of Sale as provided.*

*\*\*\*Most Metro Foodservice Products are listed by National Sanitation Foundation. For specific items, please check the latest NSF foodservice listing.*



Most Metro Foodservice Products are listed by National Sanitation Foundation. For specific items, please check the latest NSF foodservice listing.

PRODUCT	PAGE	PRODUCT	PAGE	PRODUCT	PAGE	PRODUCT	PAGE
<b>Bench, Gowning</b> .....	<b>163</b>	<b>Flexline</b> .....	<b>172-175</b>	End Load .....	133	Dust.....	50
<b>Carts</b>		<b>Frames</b>		Garment .....	162, 180	ESD Cart .....	146
Basket.....	46	Dolly .....	50	Gowning.....	162, 180	Dividers...22, 23, 35, 53, 66, 128	
Benchside .....	146	MetroMax iQ.....	27	Side Load .....	133	Enclosure Panels .....	24, 54
Chemical/Transport .....	161	Three-Sided .....	27, 55	Tray Drying .....	28	Foot Plates .....	14, 44, 69
Cleanroom Wire/Solid.....	160	<b>Furniture, Lab</b>		Turn-Out Gear.....	110	Floor Glides.....	44
Electronic Tray .....	152-154	Starsys System.....	198-227	Wire Bun Pan .....	133	Handles .....	17, 47
Feed .....	185	<b>Grounding Cables</b> .....	<b>149</b>	<b>Reel Storage, SMT</b> .....	<b>149</b>	Hooks .....	56, 128
Glassware .....	169	<b>Hangers</b>		<b>Security Trucks and Units</b> .....	<b>99-103</b>	Inlays, Shelf.....	56
Kitting .....	148	Extension Display.....	58	<b>Shelves</b>		Keyboard Tray .....	62
Lab .....	166-171	Garment Tube.....	56	Basket.....	27, 44, 130	Label Holders.....	25, 35, 59
Lab Animal Research .....	184	Rail .....	55	Cantilever .....	45, 130, 194	Ledges .....	22, 23, 53
Liquid Chromatography .....	168	Swing.....	58	Dunnage.....	14, 34, 45, 69	Leveling Feet.....	44
PCB.....	150	<b>HD qwikTRAK</b> .....	<b>88, 90-91</b>	Keyboard .....	62	Post Boot .....	44
Metal .....	176-177	<b>High-Density Storage</b> .....	<b>88-96</b>	Triangle.....	130	Power Strip .....	62
Sanitation .....	161	<b>Inventory Storage</b> .....	<b>137-140</b>	<b>Shelving</b>		Rods and Tabs .....	55
Slanted Shelf.....	47, 131	<b>Kits</b>		APPEAL .....	120-121	“S” Hooks .....	20, 21, 35, 38
Smart Tray .....	152-154	ESD.....	149	Autoclave.....	181-182	Shelf Markers .....	25, 35
Stem Caster .....	18, 39, 46	Solid Mat Overlay .....	15	Convenience Pak.....	45	Slides .....	26, 57, 66
Tray .....	155	<b>Merchandisers, Slanted Shelf</b> .....	<b>131</b>	Designer .....	43, 127	Split Sleeves.....	44
Utility		<b>Portable Power Module/Units</b> .....	<b>196-197</b>	Drop Mat .....	125	Tote Boxes .....	156
Accessories.....	48-62, 64-69	<b>Posts</b>		Erecta Shelf.....	67	Tow Bar Assembly .....	52
BC Series.....	82, 138, 166	Designer .....	43, 127	HD Super .....	68-69	Wedge Connector .....	14, 15
Deep Ledge .....	83, 138, 166	HD Super .....	68	Hi-Rise .....	96	Wire Management Clip .....	62
Heavy Duty .....	81, 138	MetroMax i .....	14	MetroMax iQ.....	22-28	<b>Smart Tray System</b> .....	<b>152-154</b>
MetroMax i .....	19, 81, 138	MetroMax Q.....	15	Platform .....	98, 131	<b>Starsys System</b> .....	<b>198-227</b>
MetroMax Q .....	19, 81	qwikSLOT.....	123	qwikSLOT.....	122-123	<b>Table Accessories</b> .....	<b>188, 191, 194</b>
Standard Duty .....	84	Super Erecta .....	36-37	Reel .....	149	<b>Tables</b> .....	<b>186-193</b>
Wine.....	132	SiteSelect.....	35, 37, 42, 147	Seismic Approved .....	104-105	<b>Top Track High-Density Storage System</b> .....	<b>89, 92-96</b>
<b>Caster Guide</b> .....	<b>49</b>	<b>Printed Circuit Board Handling</b>		Starter and Add-On Units		<b>Tote Boxes</b> .....	<b>156</b>
<b>Casters</b>		Accessories.....	151	MetroMax i .....	20	<b>Trucks</b>	
Antimicrobial .....	48	Hand-Held Carriers .....	151	MetroMax Q .....	21	Super Erecta Shelf Dolly .....	47
Cleanroom.....	161	PCB Carts.....	150-155	Super Adjustable		<b>Wall Shelving</b>	
Conductive .....	147	Smart Tray System .....	152-154	Super Erecta .....	38	Brackets.....	72-80
Decorative .....	49	<b>Racks</b>		Super Erecta .....	36-37	Erecta Shelf.....	78
Electronic .....	147	Bootie/Shoe.....	163	Super Erecta Pro .....	32-35	MetroMax i .....	78
High-Temperature .....	182	Can .....	26	Super Erecta Shelf – Solid...64-66		SmartWall G3 .....	72-77
Plate .....	51	Cleanroom Garment .....	162	Super Erecta Shelf – Wire ...36-62		Super Erecta Shelf.....	79-80
Polymer .....	16, 48	Drying .....	28	<b>Shelving Accessories</b>		<b>Wine Merchandisers</b> .....	<b>132</b>
Stainless Steel.....	16, 48, 161	Dunnage, HD Super .....	98	Baskets .....	27, 57, 58, 128	<b>WorkCenters, Mobile Computing</b> .....	<b>195</b>
Stem.....	16, 48, 147, 162, 182	Dunnage.....	97-98	Bins.....	60, 157	<b>Worktables</b> .....	<b>186-193</b>
<b>Clean Tables, Perf Top</b> .....	<b>159</b>	<b>Shelving</b>		Bumpers .....	49, 69		
<b>Computer Accessories</b> .....	<b>62</b>	Clamps		Clamps			
<b>Counter Units</b> .....	<b>65</b>	Joining.....	44, 66	Color Identification Tubes .....	58		
<b>Dollies</b>		Post.....	14, 44	<b>Covers</b>			
Made-To-Order .....	50	Autooclave.....	183	Autoclave.....	183		
Truck .....	50	Cart .....	61	Cart .....	61		

## WE PUT SPACE TO WORK. WORLDWIDE

### U.S. CUSTOMER SERVICE

Phone: 1.800.992.1776  
Fax (PA): 1.800.638.9263  
Fax: (CA): 1.800.638.3292

### CANADA CUSTOMER SERVICE

Phone: 1.905.676.9890  
Phone: 1.800.992.1776  
Fax: 1.905.676.9262

### PRODUCT INFORMATION/LITERATURE (U.S. and Canada Only):

U.S./Canadian Toll-Free  
Phone: 1.800.992.1776

### DISTRIBUTION CENTERS

California  
9393 Arrow Highway  
Cucamonga, CA 91730

Pennsylvania  
Thomas & Second Streets  
Wilkes-Barre, PA 18705

Tennessee  
3263 Elam Farms Parkway  
Murfreesboro, TN 37127

Canada  
Metropolitan Wire (Canada) LTD.  
3160 Orlando Drive  
Mississauga, Ontario  
Canada L4V 1R5

InterMetro European  
Distribution Center  
De Riemsdijk 1  
4004 LC Tiel  
The Netherlands

### INTERNATIONAL SALES/ CUSTOMER SERVICE OFFICES

Asia/Pacific  
Metro International Corporation  
27 International Business Park,  
Unit #05-02 iQuest @ IBP  
Singapore 609924  
Phone: 65.6567 8003  
Fax: 65.6567 9003

Middle East/Africa  
InterMetro Industries Corporation  
P.O. BOX: 17034  
Jebel Ali Free Zone  
Dubai-United Arab Emirates  
Phone: 009714 8118286  
fax: 009714 886 5465

Europe  
InterMetro Industries B.V.  
Heerbaan 242  
4817 NL Breda  
Breda  
The Netherlands  
Phone: 00.31.(0).76.587.7550  
Fax: 00.31.(0).76.581.1313

Latin America  
Metro International Corporation  
Bugambillas 316  
Cond. Rancho Contento  
45010 Zapopan Jalisco  
Mexico  
Phone: +52(33)362.778.30  
Fax: +52(33)368.200.41

### CORPORATE HEADQUARTERS

651 North Washington Street  
Wilkes-Barre, PA 18705  
Phone: 1.570.825.2741  
Fax: 1.570.825.2852

[www.metro.com/support](http://www.metro.com/support)  
LO4-031NP • Rev. 12/10

Information and specifications are subject to  
change without notice. Please confirm at time of order.

© 2011 InterMetro Industries Corporation, Wilkes-Barre, PA 18705  
The Emerson logo is a trademark and a service mark of Emerson Electric Company.



We put space to work.™

