

CAMBRO®



2018/19
PRODUCT CATALOG
www.cambro.com

CAMBRO® CATALOG TABLE OF CONTENTS

equipment



COMING
SOON

Ultimate Sheet Pan Rack™

The classic sheet pan rack has been reimagined and re-engineered to provide unparalleled performance and value. The Ultimate Sheet Pan Rack is made from durable composite and plastic materials that are easy to clean and can accept sheet pans straight from the oven. The unique off-set caster design minimizes tipping and provides superior stability. Backed by a lifetime warranty against rust and corrosion, the Ultimate Sheet Pan Rack will be available in three heights with 1.5" or 3" rail spacing options to hold a variety of full and half size sheet pans and trays.



INSULATED TRANSPORT

4

Insulated Food Servers (Electric)	5
Insulated Food Servers (Non-Electric)	18
Transporter Capacity Guide	25
Temperature Maintenance	26
Top-Loading Carriers	28
Cam GoBox® Insulated Lightweight Carrier	30
Insulated Beverage Servers	35
Beverage Service Cart	39
Camdollies® & Accessories	40



WAREWASHING

65

Camrack® 4-in-1 System	66
Camdollies® & Utility Trucks	80
Tray & Dish/Silver Cart	82
S-Series Adjustable Dish Caddy	83
Dish Caddies	84
Cambox® Bus Boxes	86
KD Service Cart & KD Utility Cart	87
Service Carts	88



CAMSHELVING® ELEMENTS SERIES

116

Weight Bearing Chart	117
Elements Series Configurations	118
Elements Series Accessories	123



MERCHANDISING

42

Versa Food Service System	43
Food Bar Accessories	46
Table Top Food Bars	47
Sample Food Bar Set-ups	48
CamKiosk® System	49
Hand Sink Cart	51
Camcruiser® Vending Carts	52
Camshelving Flex Station	54
Booster Seats	55
Versa Organizers	55
Portable CamBars®	56
Ice Caddies	64



CAMSHELVING® PREMIUM SERIES

89

Key Features	92
Quick Reference Guide	94
Product Code Reference Guide	96
Free Camshelving Design Service	97
Overall Length — Quick Reference Guide	98
Camshelving Premium Series	100
Weight Bearing Chart	101
Premium Series Configurations	102
Premium Series Accessories	107
High Density Storage System	112



CAMSHELVING® BASICS PLUS SERIES

128

Weight Bearing Chart	129
Basics Plus Series Configurations	130
Basics Plus Accessories	134
Wall Shelves and Shelf Extenders	136
Dunnage Racks	137
Camlink®	137

supplies



STORAGE

139

Quick Guide To Storage Solutions	140
Food Storage Containers	142
Food Storage Boxes & Lids	150
StoreSafe® Labels	154
Camwear® Food Pans & Lids	156
X-Pans®	160
H-Pans™	162
High Heat H-Pan™ with Handle(s)	166
Translucent Food Pans	167
ColdFest®	169
Pizza Dough Boxes	170
Ingredient Bins & Camcrisper®	171
Scoops & Measuring Cups	172
Allergen Management	173



DISPLAY

189

Deli Crocks & Platter	190
ShowFest® Display Bowls & Trays	191
Serving Bowls	192
Crocks & Ladles	195
Serving Spoons, Camtensils® & Turners	196
Tongs	197
Shakers/Dredges & Condiment Jars	198
Display Covers & Trays	199

healthcare



HEALTHCARE

223

Non-Skid Versa Camtrays®	224
Camwear® Non-Skid Trays & Camtrays® with Handles	225
Meal Delivery Ware System	226
Temperature Retention Systems	228
Disposable CamLids®	230
Camduction®	
Complete Heat System	231
Camtherm® Plate Heater, Reusable CamLids® & Camrack® Wash and Store Rack	232
Camshelving® Hygienic Drying Racks	233
Meal Delivery Carts	235



TABLE SERVICE

174

Camcovers®	175
Dinnerware	176
Pitchers	178
Aliso® Barware	179
Cambro Tumblers & Disposable CamLids®	180
Camliter®	185
Beverage Dispenser, Pail With Bail & Swirl Bowls®	186
Wine Buckets, Punch Bowls & Bud Vase	187
Personalization	188



TRAYS

200

Trays At A Glance	201
Personalization-Camtrays®	203
Camtrays	204
Camtrays with Handles	206
Non-Skid Versa Camtrays	209
Camwear® Trays	210
EpicTread™ Trays	211
Hotel Room Service Trays	211
Camtread® Trays	212
Treadlite™ & Polytread® Trays	213
Personalization-Camtread	214
Fast Food Trays	215
Market Trays, Pans & Camlite® Trays	216
Compartment Trays	217

GENERAL INFORMATION

Icon Directory	2
Alpha Numeric Listing	240
General Terms	254
Warranty	254
Roto Color Chart	257

PERSONALIZATION

CamKiosks®	50
Camcruisers®	53
Camracks®	78
Table Service/Storage	188
Camtrays®	203
Camtread® Trays	214
Fast Food Trays	215

www.cambro.com

Visit www.cambro.com for a wide variety of information about our products including new product updates, an interactive Camrack Glass to Rack Guide, consultant cut sheets and CAD drawings, care and maintenance product guides and more.

InStock

Cambro's top selling and most frequently used products are InStock. These products are available to ship to Certified Cambro Distributors with their next shipment. Broken cartons are excluded. InStock products are highlighted in gray throughout the Cambro Product Catalog.

The Trademarks of Cambro and product images are the property of Cambro and are subject to the control and ownership of Cambro. Any use thereof is only granted for the promotion and sales of Cambro products and subject to the control of Cambro Manufacturing Company.

the cambro® story

When William and Argyle Campbell first opened the doors at Cambro Manufacturing in 1951, their goal was to make a hospital meal tray of the highest quality possible. Named the Camtray®, it demonstrated that they were as committed to excellence in the food service industry as they were to the quality of their own products. As 2016 marked the company's 65th year of leadership in quality, innovation and customer service, today Cambro serves the world with the industry's most complete selection of products for widely diverse segments of the food service business.

Since 1951, the company has experienced many changes including a greatly expanded product line, new methods of manufacturing and distribution, and an increased emphasis on topics like environmental responsibility. From a single factory in California, Cambro has grown to become an international presence with production facilities and sales offices in the United States, Europe, the Middle East and Asia. But the original guiding vision of the Campbell brothers remains unchanged: to create and provide the most innovative, durable and highest quality products for the food service industry. Now led by William's son Argyle, Cambro is still dedicated to meeting our customers' needs, and equally committed to helping you serve, satisfy and delight your guests.

At the heart of our business philosophy is our willingness to listen, so in a very real way we owe all our success to you, our customer. Our longevity in a very competitive field for over 65 years certainly proves the value of that philosophy, and we are proud to have earned the loyalty of customers of all sizes and in all segments of the industry. From hotels to healthcare to caterers, from restaurant chains to educational facilities, we understand the food service business and we design and create our products with the end

user foremost in mind. Our goal is to provide our customers the best possible value on products that are durable, save labor and increase food safety, so you can offer your guests a superior experience while enhancing profitability.

Cambro is uniquely committed to investing in the people and processes that make our products a reality. We're proud that children and grandchildren of some of our first employees are with us today, and of the dedication to quality and service of our entire family worldwide. We continually work on developing new ideas for specific industry segments, and invest in new tooling and leading-edge machinery to bring these products to market. We persistently strive to improve our manufacturing methods to be more efficient in terms of process and materials, to keep costs under control while keeping our planet healthy. And we constantly seek to maintain quality and value despite rising costs of transport and raw materials, the need to reduce environmental impacts, and the demand of end users for total order accuracy and responsive service across a global market.

From once offering a single product, the Camtray, over sixty-five years ago, today Cambro offers a wide range of trays, table service and display items, storage, shelving, merchandising and insulated transport products, as well as innovative warewashing systems and healthcare meal delivery solutions.

The future is certain to bring great changes to our industry. Yet one thing that will remain a constant is Cambro's tradition of continually developing new products that help food service operators save time and money, increase sales, reduce labor and improve service. In the years ahead, guided by the commitment of its founders to innovation, quality, and value, Cambro Manufacturing will still be the leader in serving the food service industry and you, our valued customer.

ICON DIRECTORY

Throughout the Cambro catalog, please use the following easy-to-identify icons to help explain Cambro product features or services.



Food Safety Matters

For 65+ years, Cambro foodservice equipment and supplies have earned the trust and loyalty of customers and public health professionals alike because our products are designed with Food Safety in mind. At Cambro, every product design is based upon the core principle of food safety.

Look for the Cambro StoreSafe mark throughout the Cambro catalog to identify Cambro storage and transportation products that support safe food handling.

You can learn more about Cambro's Food Safety initiatives at www.cambro.com/storesafe



Many Cambro products may be recycled. For further information, please contact your Cambro representative.



Listed by NSF International, an independent, not-for-profit organization which certifies products that meet their criteria for sanitation and cleanability.



WARNING: This product can expose you to chemicals including Bisphenol A (BPA), which is known to the State of California to cause birth defects or other reproductive harm. For more information, go to www.P65Warnings.ca.gov.
Warning applies to State of California only.



New Product



Dishwasher Safe



Stackable



Foam Insulation



Pro-rated Warranty.



Not For Use In Heated Carts



Personalization Available
Non-Food Contact
Areas Only.



One carton of product is within the weight and cube requirements to be shipped by parcel carrier.

Note: Temperature ranges noted throughout this catalog are based on specific test criteria and provide a general guideline. Individual use may vary due to differences in loading temperatures or ambient temperature.

©Cambro Manufacturing Company. Printed in the U.S.A.



equipment

INSULATED TRANSPORT

MERCHANDISING

WAREWASHING

CAMSHELVING®

INSULATED TRANSPORT

Pro Cart Ultra™ Electric Hot, Cold and Passive

Camtherm® Electric Food Holding Cabinets

Ultra Pan Carrier® and Ultra Camcart® H-Series

Multiple GN Food Pans, Front-loading Carts

Camcarts® Sheet Pans & Trays or Food Boxes

Camcarriers®

Camcarts

Ultra Pan Carriers

Multiple GN Food Pan, Front-Loading Carriers

Transporter Capacity Guide

Temperature Maintenance Tools

Single GN Food Pan, Top-Loading Carriers

Cam GoBox® Insulated Lightweight Carrier

Insulated Beverage Servers

Insulated Beverage Server Accessories

Beverage Service Carts

Camdollies® for Insulated Beverage Servers and Carriers





PRO CART ULTRA™ (HOT, COLD AND/OR PASSIVE)

The first holding cabinet and transport cart to actively hold both hot and cold food at the same time—without a compressor.

- High capacity cart holds GN food pans, sheet pans, trays and pizza boxes in two separate, insulated cabinets.
- Customize the cart to suit your menu with a choice of active hot, active cold or passive holding in each cabinet.
- Energy efficient, active modules draw less than 5 amps each.
- Cold module uses environmentally-friendly, thermoelectric technology.
- Active modules also sold separately to quickly adapt to menu or operational changes.
- Even without electricity, this cart can maintain safe temperatures for 4+ hours.
- Comes standard with upgraded, 6" heavy duty casters.
- 110V and 220V available.

Color: Charcoal Gray (615).

Multiple International Certifications available.



PRO CART ULTRA™ (ELECTRIC HOT AND COLD)



ELECTRIC HOT

Keeps food safely between 150° to 165°F with convenient, pre-set, gentle, nonradiant heat.

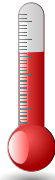

ENERGY-SAVING HEATER over 50% more

energy efficient compared to leading metal carts! Gentle, non-radiant heat circulates consistently from front to back of the cabinet.



Tall Cart

ELECTRIC COLD

Digital controller allows cold to be set from 32.5° to 40°F.

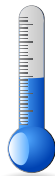

THERMOELECTRIC COOLING cools down to 32.5°F

without a compressor for the ultimate in cold mobility and food safety on the go.

Note: Operate in 90°F or less environments for best results.



Interior with Hot module

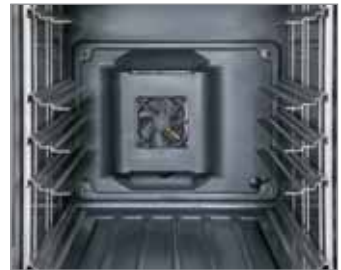

Interior with Cold module



Exterior back with Hot module



Exterior back with Cold module



Low Cart

Pre-heat time: 45 minutes.

Recovery time: 3 minutes after door open for 30 seconds.

Pre-chill time: 90 minutes to 40°F. (Tested at 73°F ambient.)

Recovery time: 10 minutes after door open for 30 seconds.

PRO CART ULTRA™ (ELECTRIC HOT AND COLD)



Holds Combinations of GN Food Pans, Sheet Pans, Trays and Pizza Boxes to suit your need.



Holding Capacity Reference



TYPE OF CONTAINER	TALL CART STANDARD CAPACITY	LOW CART STANDARD CAPACITY	TALL CART MAXIMUM CAPACITY	LOW CART MAXIMUM CAPACITY
18" x 26" FULL SIZE SHEET PANS	16	8	32*	16*
13" x 18" HALF SIZE SHEET PANS	32	16	64*	32*
GN 1/1 FOOD PANS 2½" DEEP	32	16	32	16
GN 1/1 FOOD PANS 4" DEEP	20*	10*	20	10
15¾" x 23¾" SHEET PANS**	16	8	32*	16*
PIZZA BOXES 16" x 16" x 2"	16	8	16	8

*Additional rails required. **Pans for European Market.



Easy to change modules add flexibility to any operation.

PRO CART ULTRA™ (ELECTRIC HOT AND COLD)



INSULATION
CFC-free, polyurethane insulation throughout the body and doors maximizes heat or cold retention for 4 hours or more with no electricity needed.

New!

MARINE RAIL
Creates a bonus staging area for food pans.

GASKET-FREE DOOR
For easy cleaning and fewer replacement parts. Door opens full 270°.

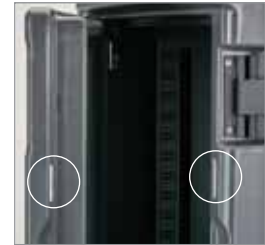

SOLAR DIGITAL THERMOMETER
Monitor internal cabinet temperature at a glance.

MAGNETIC QUICK CLOSE FEATURE
Helps the operator close the door with little effort — especially helpful when hands are full.

4" NYLON LATCHES AND ADJUSTABLE HINGES
For easy opening and closing and to secure contents during transport. (Door is lockable).

5" x 8" MENU POCKET
Allows for easy product ID with either an index card or by writing directly onto smooth surface with a grease pencil.



STANDARD 6" x 2" HEAVY DUTY CASTERS
Two non-marking, high-performance, all swivel casters with brakes in the front and two rigid casters in the back for smooth positioning and navigation.

PERIMETER BUMPER
Protects cart and walls.



STAINLESS STEEL HINGE
for long term durability.

POLYETHYLENE EXTERIOR
Keeps food moist naturally and remains cool to the touch during operation, unlike metal cabinets.

Color: Charcoal Gray (615).

Multiple International Certifications available.



Ergonomic Molded-In Handles

Will never break; great for maneuvering by operators of all heights.



Cord Keeper

Stores 9' power cord neatly and safely.



8 Sets of Stainless Steel Universal Rails



With 1.5" spacing; hold sheet pans, food pans, pizza boxes and trays (or a combination).



Rail Guides

Numbering corresponding to different holding containers helps speed set-up.

PRO CART ULTRA™ (ELECTRIC HOT AND COLD)

	CODE	DESCRIPTION	UNIT WEIGHT	LIST PRICE EA.
TALL PROFILE 	Both Compartments Hot			
	PCUHH	110V standard USA / CAN power cord 5-15P	267.5 lbs.	\$ 8,060.00
	PCUHH2	220V USA / CAN power cord 6-15P	268.4	8,060.00
	Both Compartments Cold			
	PCUCC	110V standard USA / CAN power cord 5-15P	278.4	12,585.00
	PCUCC2	220V USA / CAN power cord 6-15P	283.8	12,585.00
	Hot & Cold			
	PCUHC	Top compartment hot, bottom cold. 110V standard USA / CAN power cord 5-15P	271	11,440.00
	PCUCH	Top compartment cold, bottom hot. 110V standard USA / CAN power cord 5-15P	271	11,440.00
	PCUHC2	Top compartment hot, bottom cold. 220V standard USA / CAN power cord 6-15P	271.4	11,440.00
	PCUCH2	Top compartment cold, bottom hot. 220V standard USA / CAN power cord 6-15P	271.4	11,440.00
	Passive & Hot or Cold			
	PCUPH	Top compartment passive, bottom hot. 110V standard USA / CAN power cord 5-15P	255.3	7,260.00
	PCUPC	Top compartment passive, bottom cold. 110V standard USA / CAN power cord 5-15P	260.8	8,405.00
PCUPH2	Top compartment passive, bottom hot. 220V standard USA / CAN power cord 6-15P	255.8	7,260.00	
PCUPC2	Top compartment passive, bottom cold. 220V standard USA / CAN power cord 6-15P	263.5	8,405.00	
LOW PROFILE 	PCULH	Hot Cart, 110V standard USA / CAN power cord 5-15P	151	5,200.00
	PCULC	Cold Cart, 110V standard USA / CAN power cord 5-15P	156	7,200.00
	PCULH2	Hot Cart, 220V standard USA / CAN power cord 6-15P	151	5,200.00
	PCULC2	Cold Cart, 220V standard USA / CAN power cord 6-15P	156	7,200.00

Case Pack: 1 **Color:** Charcoal Gray (615).

Standard Railing Includes: 8 pairs of stainless steel Universal rails/compartment.

Includes Standard Casters: 6" x 2" heavy duty swivel with brake in front, rigid in back.

Options: Security Package (S) available by special request.

Unit Dimensions

UNIT	EXTERIOR DIM. W x D x H	COMPARTMENT DIM. W x D x H
Tall Profile		
COLD	28" x 36½" x 66"	21½" x 26¼" x 25½"
HOT / PASSIVE	28" x 35¾" x 66"	21½" x 27" x 25½"
Low Profile		
COLD	28" x 36½" x 40"	21½" x 26¼" x 25½"
HOT / PASSIVE	28" x 35¾" x 40"	21½" x 27" x 25½"

Electrical Specifications (Per Compartment)

	HOT 110V	HOT 220V	COLD
REQUIRED VOLTAGE	100-125 VAC	200-230 VAC	100-230 VAC
MAXIMUM AMP	4.6a	2.3a	3.26a, 1.42a
WATTS / HEATER OR COOLER	529w	506w	326.6w
HERTZ	50/60	50/60	50/60
PHASE	Single	Single	Single
ALTERNATE PLUG TYPES FOR INTERNATIONAL*	US, Canada, Mexico, Europe, UK, Ireland, Australia, South Africa, China, Japan		
POWER CORD LENGTH	9 ft.	9 ft.	9 ft.

*If country is not listed, please call Cambro Customer Service for details.

Optional Accessories

CODE	DESCRIPTION	LIST PRICE EACH
PCMH / PCMH2	Hot module unit 110V / 220V	\$ 1,622.00
PCMC / PCMC2	Cold module unit 110V / 220V	2,766.00
SSR1	1 Pair of Rails	82.00
SSR8	8 Pairs of Rails	595.00

Case Pack: 1 **Color:** (000).



PRO CART ULTRA™ (NON-ELECTRIC / PASSIVE)



8 SETS OF STAINLESS STEEL UNIVERSAL STYLE RAILS
With 1.5" spacing; hold sheet pans, food pans, pizza boxes and trays (or a combination).

GASKET-FREE DOOR
For easy cleaning and fewer replacement parts. Door opens full 270°.

SOLAR DIGITAL THERMOMETER
Monitor internal cabinet temperature at a glance.

5" x 8" MENU POCKET
Allows for easy product ID with either an index card or by writing directly onto smooth surface with a grease pencil.



STAINLESS STEEL HINGE
for long term durability.



POLYETHYLENE EXTERIOR
Keeps food moist naturally and remains cool to the touch during operation, unlike metal cabinets.

MARINE RAIL
Creates a bonus staging area for food pans.

Color: Charcoal Gray (615).

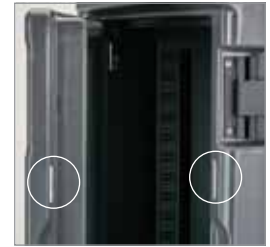

MAGNETIC QUICK CLOSE FEATURE
Helps the operator close the door with little effort — especially helpful when hands are full.

4" NYLON LATCHES AND ADJUSTABLE HINGES
For easy opening and closing and to secure contents during transport. (Door is lockable).

PERIMETER BUMPER
Protects cart and walls.

STANDARD 6" x 2" HEAVY DUTY CASTERS
Two non-marking, high-performance, all swivel casters with brakes in the front and two rigid casters in the back for smooth positioning and navigation.



INSULATION
CFC-free, polyurethane insulation throughout the body and doors maximizes heat or cold retention for 4 hours or more with no electricity needed.



Interior
Easy to clean interior.



Exterior Back
Non-electric cart holds hot or cold foods for 4 hours or more.



Ergonomic Molded-In Handles
Will never break; great for maneuvering by operators of all heights.



Rail Guides
Numbering corresponding to different holding containers helps speed set-up.



PRO CART ULTRA™ (NON-ELECTRIC / PASSIVE)

CODE	DESCRIPTION	DIMENSIONS W x D x H	UNIT WEIGHT	LIST PRICE EA.
Tall Profile				
PCUPP	Both compartments non-electric / passive	28" x 35¼" x 66"	235.2 lbs.	\$ 6,035.00
Low Profile				
PCULP	Non-electric / passive	28" x 35¼" x 40"	140	3,800.00

Case Pack: 1 **Color:** Charcoal Gray (615).
Standard Railing Includes: 8 pairs of stainless steel Universal rails/compartments.
Includes Standard Casters: 6" x 2" heavy duty swivel with brake in front, rigid in back.
Compartment Dimensions: 21½" x 27" x 25½"
Options: Security Package (S) available by special request.

Optional Accessories

CODE	SSR1	SSR8
DESCRIPTION	1 Pair of Rails	8 Pairs of Rails
LIST PRICE EACH	\$ 82.00	\$ 595.00

Case Pack: 1 **Color:** (000).

Hot — temperature loss averaging 3°F/hour.

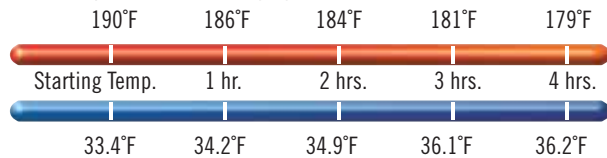

Cold — temperature gain averaging 0.7°F/hour.

Security Package (S)

Specially designed for operations where safety and security are a top priority.

- Tamper resistant fasteners secure side column panels to the cart.
- Cross locking rods behind column panels lock 5 rails in place.
- Each compartment holds ten 4" deep hotel pans.
- Passive and electrical modules and cord strap keepers are secured in place with tamper resistant fasteners.
- Non removable doors. Lockable HASP secures both doors at once. (Lock not included).
- Heavy duty casters mounted with tamper resistant fasteners.



INSULATED FOOD SERVERS (ELECTRIC) – CAMTHERM® ELECTRIC FOOD HOLDING CABINETS



Hot Only Models



Go From Hot to Cold in One Versatile Cart!

- Use for bulk food holding in the kitchen or to transport large amounts of food off-site.
- Go from hot to cold with the simple flip of a switch!
- Tough polyethylene exterior will not dent, rust or chip; stays cool to the touch during operation, unlike metal cabinets.
- Thick polyurethane foam insulation maintains safe food holding temperatures for 4 hours or more, even unplugged.
- Available in two sizes and hot only or hot/cold models.

Energy-efficient thermoelectric heating and cooling with:

No Compressor, heating coil or humidifier.

Low voltage, amps, wattage.



48%
More
Energy
Efficient

Than Leading Metal Cabinets



INSULATED FOOD SERVERS (ELECTRIC)

Camtherm® Electric Food Holding Cabinets

KNUCKLE DOOR HINGES

Withstand rigorous door openings, allows door to be lifted up and off for easy cleaning.

DOOR SWINGS OPEN 270°

for easy loading.

MARINE RAILING

Holds 2 full-sized food pans, 1 full-sized sheet pan or cutting board (CB1220).

SOLAR DIGITAL THERMOMETER

Monitor internal temperature at a glance.

SELF-VENTING CAP

Releases steam and equalizes pressure, maintaining food quality.

MENU CLIP

For easy product/event identification.

ADJUSTABLE CHROME-PLATED STEEL SLIDE RAILS

Hold full-size food pans or sheet pans.

POLYETHYLENE EXTERIOR

Stays cool to the touch during operation.

ERGONOMIC MOLDED-IN HANDLES

For easy maneuvering even when fully loaded.

ALUMINUM LOUVERS

Gently circulate hot or cold air evenly.

WIDE NYLON DOOR LATCHES/MAGNETIC DOOR GASKETS

Lock doors securely and create a tight seal to retain safe hot or cold food temperatures.

MOLDED-IN BUMPERS

Protect walls and furniture.

CONTROL PANEL (in back) On/Off switch
Temperature control dial for hot only models
[Hot pre-set between 150° to 165°F (65° to 74°C)].

Hot/Cold switch for Hot/Cold Models only
[Cold pre-set to 37°F (2,8°C)].

TRANSITION TIME

Cold to Hot: 1.5 to 2.5 hrs.
Hot to Cold: 3 hrs.

Camtherm® Electrical Specifications



ELECTRICAL SPECIFICATIONS	LOW PROFILE HOT ONLY	LOW PROFILE HOT/COLD	TALL PROFILE HOT ONLY	TALL PROFILE HOT/COLD
VOLTS	110V	110V	110V	110V
PLUG TYPE	Nema 5-15P	Nema 5-15P	Nema 5-15P	Nema 5-15P
MAXIMUM AMP DRAW	9.1 amps	10.7 amps	14 amps	14.3 amps
AMPS RUN ON	9 amps	10.1 amps	13.8 amps	13.6 amps
WATTS	1035	1162	1587	1570
HERTZ	50/60	50/60	50/60	50/60
POWER INPUT OF HEATING UNIT	110-120 VAC	110-120 VAC	110-120 VAC	110-120 VAC

Assembly is covered by U.S. Patent D 442,756 S & D 6,344,630.

INSULATED FOOD SERVERS (ELECTRIC)

Camtherm® Capacity Specifications

HOLDING CAPACITY	LOW PROFILE	HIGH PROFILE
Sheet Pans		
18" x 26" (45,7 x 66 cm)	11*	22**
Full-Size Food Pans		
2½" (6,5 cm) Deep	12	24
4" (10 cm) Deep	8	16
6" (15 cm) Deep	6	12
8" (20 cm) Deep	4	8

*Requires five additional rail sets **Requires five additional rail sets.

Security Package







Specially designed for operations where safety and security are a top priority.

- Tamper-resistant fasteners.
- One-piece, welded and secured rail and upright assembly.
- Lockable hasp on each door (padlocks not included).



Product Specifications

CAD drawings, cut sheets and user manual available at www.cambro.com.

	CODE	THERMOMETER	CASTERS	UNIT WEIGHT	LIST PRICE EA.	
  	LOW PROFILE					
	EXTERIOR dimensions: W 30½" x D 42" x H 42¾"					
	Hot Only					
		CMBH1826LF	Fahrenheit	2 front 6" swivel w/brake, 2 rear 10" rigid	164 lbs.	\$ 6,265.00
		CMBH1826LC	Celsius	2 front 6" swivel w/brake, 2 rear 10" rigid	164	6,265.00
	Hot/Cold					
		CMBHC1826LF	Fahrenheit	2 front 6" swivel w/brake, 2 rear 10" rigid	222	14,765.00
		CMBHC1826LC	Celsius	2 front 6" swivel w/brake, 2 rear 10" rigid	222	14,765.00
	LOW PROFILE WITH SECURITY PACKAGE (SP)					
	Hot Only					
		CMBH1826LSP	Fahrenheit	2 front 6" swivel w/brake, 2 rear 10" rigid	167.4	6,560.00
	Hot/Cold					
		CMBHC1826LSP	Fahrenheit	2 front 6" swivel w/brake, 2 rear 10" rigid	225.4	15,105.00
	  	TALL PROFILE				
EXTERIOR dimensions: W 30½" x D 39" x H 64¾"						
Hot Only						
		CMBH1826TSF	Fahrenheit	2 front 6" swivel w/brake, 2 rear 6" rigid	250 lbs.	\$ 9,785.00
		CMBH1826TBF	Fahrenheit	2 front 6" swivel w/brake, 2 rear 10" rigid	254	9,785.00
		CMBH1826TSC	Celsius	2 front 6" swivel w/brake, 2 rear 6" rigid	250	9,785.00
		CMBH1826TBC	Celsius	2 front 6" swivel w/brake, 2 rear 10" rigid	254	9,785.00
Hot/Cold						
		CMBHC1826TSF	Fahrenheit	2 front 6" swivel w/brake, 2 rear 6" rigid	325.5	20,740.00
		CMBHC1826TBF	Fahrenheit	2 front 6" swivel w/brake, 2 rear 10" rigid	330	20,740.00
		CMBHC1826TSC	Celsius	2 front 6" swivel w/brake, 2 rear 6" rigid	325.5	20,740.00
		CMBHC1826TBC	Celsius	2 front 6" swivel w/brake, 2 rear 10" rigid	330	20,740.00
TALL PROFILE WITH SECURITY PACKAGE (SP)						
Hot Only						
	CMBH1826TSP	Fahrenheit	2 front 6" swivel w/brake, 2 rear 10" rigid	260.77	10,325.00	
Hot/Cold						
	CMBHC1826TSP	Fahrenheit	2 front 6" swivel w/brake, 2 rear 10" rigid	337	21,315.00	
Cabinet Colors: Granite Gray (191), Granite Green (192), Granite Sand (194).						

ACCESSORIES	CODE	DESCRIPTION	DIMENSIONS L x W x H	CASE PACK	LIST PRICE EA.
	CMBR	Set of slide rails	20" x 4¼"	1 set of 2 Rails	\$ 55.00
	CB1220	Cutting board	21" x 13⅞" x ½"	1 each	42.00

Cutting Board Color: White (148). Venting plug is covered by US Patent D 553,717 S.

INSULATED FOOD SERVERS (ELECTRIC)

Ultra Pan Carrier® and Ultra Camcart® H-Series

- Designed for both electric hot holding and non-electric transport.
- Gentle, 150° to 165°F non-radiant heat will not cook food and maintains food moisture.
- Holds a wide variety of foods such as pasta, bone-in fried chicken, and double-cruste pies.

- One hour preheat time from room temperature and three minute recovery.
- Energy consumption is substantially less than comparable metal cabinets.
- Will not rust or dent like metal cabinets, is more economical, and is easy to maneuver.
- All UPCH models have been tested to maintain safe, hot food temperatures, for up to 4 hours when unplugged.
- Models with only the top heated door offer unique versatility with an electric hot holding cabinet on top and passive hot or cold food holding on the bottom.

- Heated door kits also sold separately to retrofit UPC400, UPC800 and UPC1600.

Colors: Granite Gray (191), Granite Green (192), Slate Blue (401), Dark Brown (131), Black (110).

Casters: 6" - 2 fixed, 2 swivel, 1 with brake.



Power On and Heat on Indicators

Communicate the Power and Heating status of the UPCH1600 unit. Know instantly when the compartment has reached target temperature.



Vents

Consistent heating throughout the compartment is generated by vents that constantly circulate heat from front to back.



Tough Exterior

All UPCH units are made of tough polyethylene with polyurethane foam insulation to keep heat in while keeping the exterior cool to the touch. Will not crack, dent, chip, rust or break.

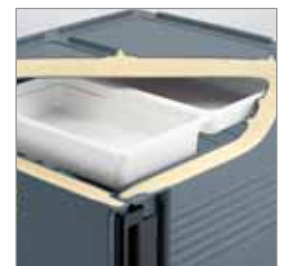

Insulation

CFC-free, foamed-in place polyurethane foam insulation will hold temperature above 148°F for up to 4 hours when used unplugged.

INSULATED FOOD SERVERS (ELECTRIC)

Marine rail is designed for use during service, not transport.

Ultra Pan Carrier® and Ultra Camcart® H-Series



UPCH400 / 4002

UPCH800 / 8002

UPCH1600 / 16002

MODEL	UPCH400/ UPCH800 (110 VAC MODELS)	UPCH4002/ UPCH8002* (220 VAC MODELS)	UPCH1600 (110 VAC MODELS)	UPCH16002* (220 VAC MODELS)
Electrical Specifications				
REQUIRED VOLTAGE	110 – 120 VAC	200 – 230 VAC	110 – 125 VAC	200 – 230 VAC
MAXIMUM AMP.	2.0a	1.2a	4.6a	1.2a
WATTS	230w	265w	529w	265w
HERTZ	50/60	50/60	50/60	50/60
PLUG TYPE	Nema 5-15P	Euro plug, CEE7	5-15P to C15RA	CEE7/7 to C15RA
POWER CORD LENGTH	9 feet	2,7 m	9 feet	2,7 m

*No U.S. 220V model available.

Hot — temperature loss averaging 3°F/hour.

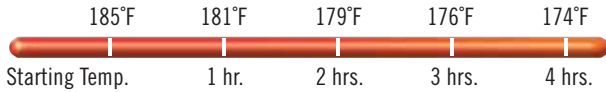

HOT HOLDING	150° — 165°F
WARM UP TIME (from ambient to temperature)	1 hour
RECOVERY TIME* (time to recover to temperature after door is held open for 30 seconds)	3 minutes
TRANSPORT TIME* (after reaching temperature, amount of time unit can be held passively/unplugged until contents reach 148°F.)	4 hours+

*Based on test with 4 full-sized, 4" deep H-Pans™ filled with 190°F hot water.

Capacity Guide

UPCH400
UPCH800 (x2)
UPCH1600 (x4)

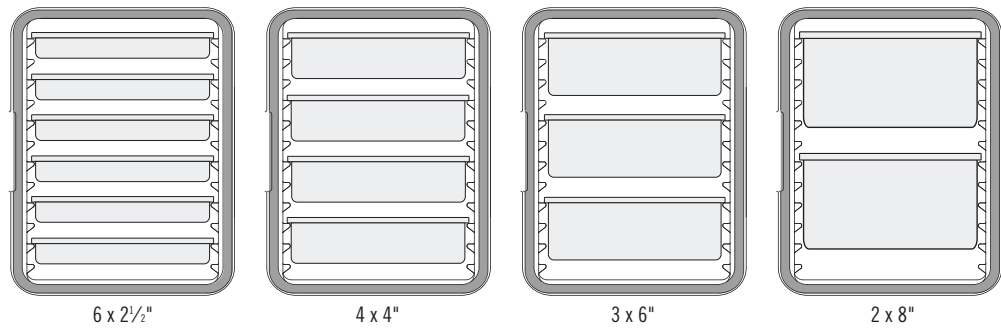

Food Pan Portion Guide

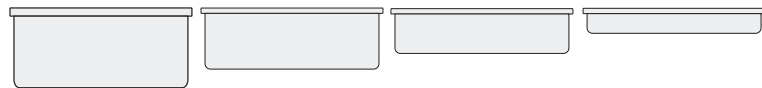

GN 1/1 FOOD PAN	8"	6"	4"	2 1/2"
DEPTH	8"	6"	4"	2 1/2"
SERVING PORTIONS PER PAN (1 CUP)	80	60	40	30

INSULATED FOOD SERVERS (ELECTRIC)

Ultra Pan Carrier® and Ultra Camcart® H-Series

Colors: Granite Gray (191),
Granite Green (192), Slate Blue (401),
Black (110), Dark Brown (131).



- Enables HACCP compliance by maintaining safe, hot food temperatures.
- UPCH400 models stack for storage or transporting on a Camdolly® with securing strap.

Security Package (SP)

Specially designed for operations where safety and security are a top priority.

- Tamper-resistant fasteners.
- Non-removable doors.
- Lockable hasp on each door. (padlocks not included)
- Heavy duty (HD) casters with chassis plates mounted with tamper resistant bolts.

CODE	CASTERS	LIST PRICE EA.
UPCH1600SP	6" x 2"	\$ 6,055.00
UPCH16002SP	6" x 2"	6,055.00



CODE	DESCRIPTION	EXTERIOR DIMENSIONS W x D x H	COMPARTMENT DIMENSIONS W x D x H	LIST PRICE EA.
1-Compartment Ultra Pan Carriers				
110V				
UPCH400	No casters	18 ³ / ₈ " x 26 ³ / ₈ " x 24 ⁷ / ₈ "	13 ³ / ₈ " x 21" x 19 ³ / ₈ "	\$ 1,475.00
UPCHW400	With casters	18 ³ / ₈ " x 26 ³ / ₈ " x 31 ¹ / ₄ "	13 ³ / ₈ " x 21" x 19 ³ / ₈ "	1,675.00
220V*				
UPCH4002	No casters	18 ³ / ₈ " x 26 ³ / ₈ " x 24 ⁷ / ₈ "	13 ³ / ₈ " x 21" x 19 ³ / ₈ "	1,475.00
UPCHW4002	With casters	18 ³ / ₈ " x 26 ³ / ₈ " x 31 ¹ / ₄ "	13 ³ / ₈ " x 21" x 19 ³ / ₈ "	1,675.00
2-Compartment Ultra Camcarts				
110V				
UPCH800	Both doors heated	20 ¹ / ₂ " x 27 ¹ / ₈ " x 54"	13" x 21 ¹ / ₂ " x 19 ³ / ₈ "	3,625.00
UPCHT800	Top door heated only	20 ¹ / ₂ " x 27 ¹ / ₈ " x 54"	13" x 21 ¹ / ₂ " x 19 ³ / ₈ "	2,760.00
UPCH1600	Both doors heated	28 ³ / ₄ " x 33 ³ / ₈ " x 54 ¹ / ₂ "	21" x 26 ³ / ₈ " x 21"	5,875.00
UPCH1600HD	Both doors heated, HD casters	28 ³ / ₄ " x 33 ³ / ₈ " x 54 ¹ / ₂ "	21" x 26 ³ / ₈ " x 21"	6,040.00
UPCHT1600	Top door heated only	28 ³ / ₄ " x 33 ³ / ₈ " x 54 ¹ / ₂ "	21" x 26 ³ / ₈ " x 21"	4,575.00
UPCHT1600HD	Top door heated only, HD casters	28 ³ / ₄ " x 33 ³ / ₈ " x 54 ¹ / ₂ "	21" x 26 ³ / ₈ " x 21"	4,740.00
220V*				
UPCH8002	Both doors heated	20 ¹ / ₂ " x 27 ¹ / ₈ " x 54"	13" x 21 ¹ / ₂ " x 19 ³ / ₈ "	3,625.00
UPCHT8002	Top door heated only	20 ¹ / ₂ " x 27 ¹ / ₈ " x 54"	13" x 21 ¹ / ₂ " x 19 ³ / ₈ "	2,760.00
UPCH16002	Both doors heated	28 ³ / ₄ " x 33 ³ / ₈ " x 54 ¹ / ₂ "	21" x 26 ³ / ₈ " x 21"	5,875.00
UPCH16002HD	Both doors heated, HD casters	28 ³ / ₄ " x 33 ³ / ₈ " x 54 ¹ / ₂ "	21" x 26 ³ / ₈ " x 21"	6,040.00
UPCHT16002	Top door heated only	28 ³ / ₄ " x 33 ³ / ₈ " x 54 ¹ / ₂ "	21" x 26 ³ / ₈ " x 21"	4,575.00
UPCHT16002HD	Top door heated only, HD casters	28 ³ / ₄ " x 33 ³ / ₈ " x 54 ¹ / ₂ "	21" x 26 ³ / ₈ " x 21"	4,740.00
Accessories for 1-Compartment (See Accessories Page 30)		W x D x H	W x D	
CD400	Camdollies®	21 ¹ / ₁₆ " x 28 ³ / ₈ " x 9"	18 ¹ / ₂ " x 25 ¹ / ₁₆ "	360.00
400STP	150" long strap	—	—	15.00

UPCH Case Pack: 1 *No U.S. 220V model available.

Also Available: Top and Bottom Replacement/Retrofit Doors for 110V and 220V (non-interchangeable).

InStock Colors: Black (110), Dark Brown (131).

Standard Casters: 6" x 1¹/₄" – 2 fixed, 2 swivel, 1 with brake.

Heavy Duty (HD) Casters: 6" x 2" – 2 fixed, 2 swivel with brake.

INSULATED FOOD SERVERS (NON-ELECTRIC)



Multiple GN Food Pan, Front-Loading Carts

- Double-compartment, high-capacity carts hold and transport hot or cold food.
- Tough, polyethylene shell and thick foam insulation throughout cabinet and between compartments maintain safe food temperatures for 4 hours or more.
- Easy to maintain and won't dent, crack, rust, or chip.
- Durable nylon door latches open easily and close securely.
- Full-swing doors open to the side of the cart for easy loading and unloading.
- Airtight removable gaskets
- Molded-in handles ensure easy maneuvering.
- Molded-in bumpers minimize damage to walls, furniture and other equipment.

Colors: Navy Blue (186), Slate Blue (401), Coffee Beige (157), Dark Brown (131), Brick Red (402), Green (519), Black (110), Hot Red (158), Granite Gray (191), Granite Green (192), Granite Sand (194).

Note: Place food pans on rails. Pans should not be placed on the floor of a Camcart cavity. Please use specified food pan sizes.

Note: Best results will be achieved by loading food pans between 180° to 190°F (82° to 88°C). Loading metal food pans over 250°F (121°C) may result in damage to the carrier or cart.

Venting plug is covered by US Patent D 553,717 S.



Marine rail is designed for use during service, not transport.



Polyurethane insulation keeps hot food hot and cold food cold.



Shown with optional HD casters.

TOTAL CART HOLDING CAPACITY	UPC600	UPC800	UPC1200	UPC1600
Full Size Food Pans				
2½" deep	8 pans	12 pans	16 pans	24 pans
4" deep	6 pans	8 pans	12 pans	16 pans
6" deep	4 pans	6 pans	8 pans	12 pans
8" deep	2 pans + 2 each 4" pans	4 pans	4 pans	8 pans
Camtray®*				
3253	12 trays	24 trays	24 trays	48 tray
2632	24 trays	48 tray	—	—
2025	—	—	12 trays	24 trays

See Food Pan and Camtray Section for pricing and ordering information.
*Based on 3" spacing between trays.

Hot — temperature loss averaging 3°F/hour.

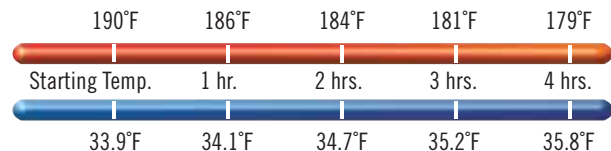

Cold — temperature gain averaging 1.5°F/hour.



INSULATED FOOD SERVERS (NON-ELECTRIC)



Ultra Camcarts®



CODE	UPC600	UPC800 (UPC800SP)	UPC1200
DESCRIPTION	Base model	Base model (Security package)	Base model
EXTERIOR DIM. W x D x H	20½" x 27⅞" x 45"	20½" x 27⅞" x 54"	28½" x 32¼" x 45½"
COMPARTMENT DIM. W x D x H	13⅝" x 21⅝" x 14"	13" x 21½" x 19⅞"	21⅞" x 26⅞" x 13½"
CASTERS	5" x 1¼" casters	6" x 1¼" (6" x 1½" HD casters)	6" x 1¼" casters
TEMPERATURE MAINTENANCE TOOLS	1210PW Camwarmer®, 300DIV ThermoBarrier®, CP1220 and CP1210 Camchiller®	1210PW Camwarmer, 400DIV ThermoBarrier, CP1220 and CP1210 Camchiller	1200DIV Thermo Barrier, CP1220 Camchiller
LIST PRICE EACH	\$ 1,280.00	\$ 1,515.00 (\$ 1,630.00)	\$ 1,970.00

Case Pack: 1 Casters: 5" or 6" x 1¼", 2 fixed, 2 swivel, 1 with brake. **Heavy Duty (HD) Casters:** 6" x 1½", 2 fixed, 2 swivel with brake casters.



Security Package (SP)

Specifically designed for operations where safety and security are a top priority.

- Tamper-resistant fasteners.
- Non-removable doors.
- Lockable hasp on each door (padlocks not included).
- Heavy duty (HD) casters with chassis plates mounted with tamper resistant bolts.



CODE	UPC1600	UPC1600HD	UPC1600SP	UPC6L1600SP
DESCRIPTION	Base model	Base model with HD casters	Security package	Security package, gasketless
EXTERIOR DIM. W x D x H	28¼" x 33⅞" x 54½"	28¼" x 33⅞" x 54½"	28¼" x 33⅞" x 54½"	28¼" x 33⅞" x 54½"
COMPARTMENT DIM. W x D x H	21" x 26⅞" x 21"	21" x 26⅞" x 21"	21" x 26⅞" x 21"	21" x 26⅞" x 21"
CASTERS	6" x 1¼" casters	6" x 2" HD casters	6" x 2" HD casters	6" x 2" HD casters
TEMPERATURE MAINTENANCE TOOLS	1600DIV Thermo Barrier, CP1220 Camchiller	1600DIV ThermoBarrier, CP1220 Camchiller	1600DIV ThermoBarrier, CP1220 Camchiller	1600DIV ThermoBarrier, CP1220 Camchiller
LIST PRICE EACH	\$ 2,835.00	\$ 2,985.00	\$ 3,095.00	\$ 2,860.00

Case Pack: 1 Casters: 5" or 6" x 1¼", 2 fixed, 2 swivel, 1 with brake. **Heavy Duty (HD) Casters:** 6" x 2", 2 fixed, 2 swivel with brake casters.

INSULATED FOOD SERVERS (NON-ELECTRIC)



Camcarts®

- Use to hold hot or cold bulk food stored on trays, sheet pans or in food boxes.
- Durable polyethylene and thick foam insulation retain safe food temperatures.
- Sturdy plastic, rust-proof latches are secured into molded-in mounting plates.
- Molded-in handle on the back for easy maneuvering.



Colors: Slate Blue (401), Coffee Beige (157), Dark Brown (131), Charcoal Gray (615).

6" Casters: 2 fixed, 2 swivel, 1 with brake.

Note: Cool metal sheet pans to 250°F before placing onto tray supports.

Venting plug is covered by US Patent D 553,717 S.

Only 1826DBC and 1826DBCSP are NSF Listed.



1826DTC Double Cavity Cart for Trays and Sheet Pans

Capacity: 24 tray support rails on 1⁵/₁₆" centers (12 per cavity). Holds up to 24 each 18" x 26" (46 x 66 cm) trays or sheet pans.

1826DBC Double Cavity Cart for Food Storage Boxes

Capacity: 26 support rails on 1³/₄" centers (13 per cavity). Holds 18" x 26" (46 x 66 cm) Food Storage Boxes.

Camcart with Security Package (SP)

Specially designed for high security applications, with tamper-resistant hardware: metal hinges with non-removeable pins, metal latches with welded bails, lockable hasp and chassis plate.



CASTER IMPACT PLATES

Impact plates add metal reinforcement to hold casters in place even when dropped.

CODE	DESCRIPTION	EXTERIOR DIMENSIONS W x D* x H	INTERIOR DIMENSIONS W x D x H	LIST PRICE EA.
1826DTC	For trays & sheet pans	33 ³ / ₄ " x 21 ¹ / ₂ " x 63 ³ / ₄ "	26 ¹ / ₂ " x 18 ¹ / ₄ " x 25 ⁷ / ₁₆ "	\$ 2,535.00
1826DBC	For food storage boxes	33 ³ / ₄ " x 21 ¹ / ₂ " x 63 ³ / ₄ "	26 ¹ / ₂ " x 18 ¹ / ₃₂ " x 25 ⁷ / ₁₆ "	2,535.00
Camcarts with Security Package				
1826DTCSP	For trays & sheet pans	33 ³ / ₄ " x 21 ¹ / ₂ " x 63 ³ / ₄ "	26 ¹ / ₂ " x 18 ¹ / ₄ " x 25 ⁷ / ₁₆ "	3,225.00
1826DBCSP	For food storage boxes	33 ³ / ₄ " x 21 ¹ / ₂ " x 63 ³ / ₄ "	26 ¹ / ₂ " x 18 ¹ / ₃₂ " x 25 ⁷ / ₁₆ "	3,205.00

Case Pack: 1 *Exterior Depth measurement includes handle.

INSULATED FOOD SERVERS (NON-ELECTRIC)

Camcarriers®

- Holds sheet pans, trays and GN food pans.
- One piece seamless construction with molded-in handles.

Colors: Black (110), Slate Blue (401), Coffee Beige (157), Dark Brown (131), Navy Blue (186), Charcoal Gray (615). 1318CC also available in Hot Red (158).

Refer to page 40 for Camdollies listing.

Note: Cool metal sheet pans to 250°F before placing onto tray supports.

Venting plug is covered by U.S. Patent D 553,717S.



Combo Carrier

1318CC

Holds half-size sheet pans, trays and a variety of food pan sizes. Safely keeps cold food below 41°F, hot food above 140°F for 4+ hours. Interstacks with UPC300, 300MPC, 1318MTC.

EXTERNAL DIM. W x D x H*: 17" x 25¼" x 22⅝"

INTERIOR DIM. W x D x H: 13¼" x 21" x 14"

FITS CAMDOLLY: CD300, CD300H, CD300HB

LIST PRICE EACH: \$ 530.00

Case Pack: 1 *With Handle.



Camcarrier

1826MTC

Holds up to 6 each 18" x 26" sheet pans. Six tray supports on 2½" centers.

EXTERNAL DIM. W x D x H*: 21½" x 29¼" x 22⅝"

INTERIOR DIM. W x D x H: 18⅝" x 26⅞" x 14⅞"

FITS CAMDOLLY: CD1826MTC, CD1826MTCHB

LIST PRICE EACH: \$ 795.00

Case Pack: 1 *With Handle.



1826HAR

Lifting harness.

DIMENSION: 142" long

LIST PRICE EACH: \$ 90.00

Color: Beige (000).

Camcarts®

- Holds sheet pans, trays and food boxes.
- Includes removable cutting board on top.
- Security Package (SP)** features tamper-resistant hardware to protect both cart and contents. Includes chassis plates with 6" x 1½" HD Casters.

Colors: Slate Blue (401), Coffee Beige (157), Dark Brown (131), Navy Blue (186), Charcoal Gray (615).

Standard Casters: 6" x 1¼", 2 fixed, 2 swivel, 1 with brake.

Heavy Duty (HD) Casters: 6" x 1½", 2 fixed, 2 swivel, no brake.

Note: Cool metal sheet pans to 250°F before placing onto tray supports.

Venting plug is covered by U.S. Patent D 553,717S.



Camcart for Food Storage Boxes

1826LBC / 1826LBCSP**

Holds 18" x 26" Food Storage Boxes. 13 supports on 1¾" centers.

EXTERNAL DIM. W x D x H: 21½" x 32" x 37½"

INTERIOR DIM. W x D x H: 18⅝" x 26⅞" x 25⅞"

LIST PRICE EACH: \$ 1,520.00 / \$ 1,890.00

Case Pack: 1



Camcart for Trays and Sheet Pans

1826LTC / 1826LTCSP**

Holds up to 13 each 18" x 26" trays or sheet pans. 13 tray supports on 1¾" centers.

EXTERNAL DIM. W x D x H: 21½" x 32" x 37½"

INTERIOR DIM. W x D x H: 18⅝" x 26⅞" x 25⅞"

LIST PRICE EACH: \$ 1,535.00 / \$ 1,920.00

Case Pack: 1



Camcart for Trays and Sheet Pans

1826LTC3

Holds up to 7 each 18" x 26" trays or sheet pans. Seven tray supports on 3¾" centers with 3" clearance between trays.

EXTERNAL DIM. W x D x H: 21½" x 32" x 37½"

INTERIOR DIM. W x D x H: 18⅝" x 26⅞" x 25⅞"

LIST PRICE EACH: \$ 1,535.00

Case Pack: 1



INSULATED FOOD SERVERS (NON-ELECTRIC)



Ultra Pan Carrier® UPC400

- Fit four 4" deep full-size food pans.
- Hold hot or cold food safely for 4 hours or more.

Colors: Navy Blue (186), Slate Blue (401), Coffee Beige (157), Dark Brown (131), Black (110), Granite Gray (191), Granite Green (192), Granite Sand (194).

UPC400 is covered by US Patent D 392,158. Venting plug is covered by US Patent D 553,717 S.

Note: Place food pans on rails. Pans should not be placed on the floor of a Camcarrier® cavity. Please use specified food pan sizes.

Note: Best results will be achieved by loading food pans between 180° to 190°F (82° to 88°C). Loading metal food pans over 250°F (121°C) may result in damage to the carrier or cart.



ERGONOMIC DESIGN

Unbreakable, ergonomic, molded-in handles for comfortable two-person carrying.



PRESSURE AND HUMIDITY CONTROL
Pop-up vent.



TEMPERATURE RETENTION
Polyurethane insulation keeps hot food hot and cold food cold.



QUICK ACCESS
Single, 9" nylon latch for quick and secure opening and closing.

REMOVABLE GASKET

Provides an airtight seal.

Hot — temperature loss averaging 3°F/hour.

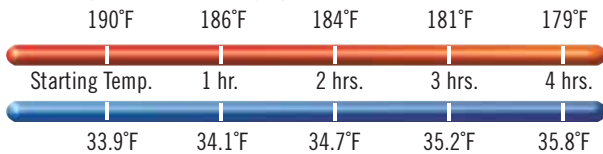

Cold — temperature gain averaging 1.5°F/hour.

CODE

	UPC400 / UPC400SP**
EXTERIOR DIM. W x D x H	18" x 25" x 24 1/4"
INTERIOR DIM. W* x D x H	13 1/2" x 21" x 19 1/8"
UNIT WEIGHT	32 lbs. / 36 lbs.
FITS CAMDOLLY®	CD400
LIST PRICE EACH	\$ 595.00 / \$ 660.00

Case Pack: 1 **InStock Colors:** Coffee Beige (157), Black (110). *Rail to Rail
****Security Package (SP) Model:** Tamper-resistant fasteners.
 Non-removable doors. Lockable hasp on each door (padlocks not included).

UPC400 Holding Capacity

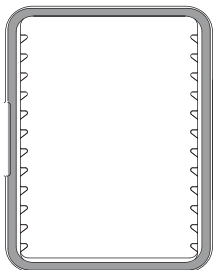

UPC400 rail configuration

HOLDING CAPACITY:

Pan Depth	Number of GN 1/1 pans
2 1/2"	6
4"	4
6"	3
8"	2

Also holds GN 1/2 and 1/3 size pans.

Optional Accessories



CODE	CD400	400STP
DESCRIPTION	Camdolly®	Strap
EXTERIOR DIM.	21 1/16" x 28 1/8" x 9"	150" long
INTERIOR DIM.	18 1/2" x 25 3/16"	—
COLOR	▲	Beige (000)
LIST PRICE EACH	\$ 360.00	\$15.00

Case Pack: 1 ▲ **CD400 Colors:** Coffee Beige (157), Dark Brown (131), Black (110), Slate Blue (401).

INSULATED FOOD SERVERS (NON-ELECTRIC)

Ultra Pan Carrier® S-Series UPCS400

- Fit four 4" deep full-size food pans.
- Hold hot or cold food safely for 4 hours or more.

Colors: Slate Blue (401), Speckled Grey (480), Dark Brown (131).

Note: Place food pans on rails. Pans should not be placed on the floor of a Camcarrier® cavity. Please use specified food pan sizes.

Note: Best results will be achieved by loading food pans between 180° to 190°F (82° to 88°C). Loading metal food pans over 250°F (121°C) may result in damage to the carrier or cart.



CONVENIENT
Integrated pan-staging area eases service (not for use during transport).

EASY TO CLEAN
Door removes for easy cleaning.



TEMPERATURE RETENTION
Polyurethane insulation keeps hot food hot and cold food cold.



MENU CLIP
Reduces need to open door.

ERGONOMIC DESIGN
Unbreakable, ergonomic, molded-in handles for comfortable two-person carrying.

QUICK ACCESS
Single, 9" nylon latch for quick and secure opening and closing.



BUILT-IN SEAL
Eliminates need for removable gasket.

PRESSURE CONTROL
Built-in vent.

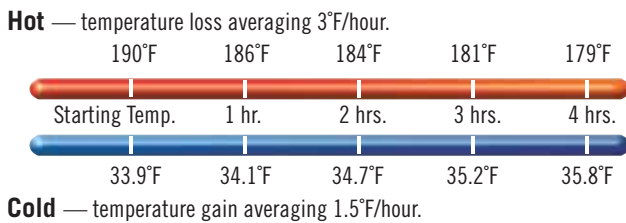

CODE	UPCS400
EXTERIOR DIM. W x D x H	18" x 26¼" x 25"
INTERIOR DIM. W x D x H	13⅞" x 21" x 19⅞"
UNIT WEIGHT	44.3 lbs.
FITS CAMDOLLY	CD400
LIST PRICE EACH	\$ 535.00

Case Pack: 1 InStock Colors: Speckled Gray (480), Dark Brown (131).

UPCS400 Holding Capacity

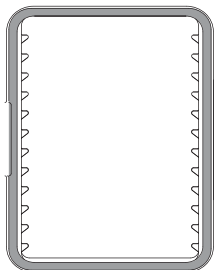

UPCS400 rail configuration

HOLDING CAPACITY:

Pan Depth	Number of GN 1/1 pans
2½"	6
4"	4
6"	3
8"	2

Also holds GN 1/2 and 1/3 size pans.

Optional Accessories



CODE	UPCS400CK	CD400	400STP
DESCRIPTION	Caster Kit*	Camdolly®	Strap
EXTERIOR DIM.	5"	21⅛" x 28⅜" x 9"	150" long
INTERIOR DIM.	—	18½" x 25⅞"	—
COLOR	—	▲	Beige (000)
LIST PRICE EACH	\$ 139.05	\$ 360.00	\$15.00

Case Pack: 1 *Optional Caster Kit for UPCS400: 2 fixed, 2 swivel, 1 w/ brake.
▲ CD400 Colors: Coffee Beige (157), Dark Brown (131), Black (110), Slate Blue (401).

INSULATED FOOD SERVERS (NON-ELECTRIC)



Multiple GN Food Pans, Front-loading Carriers

- Holds full-size GN 1/1, GN 1/2 and GN 1/3 pans.
- One-piece seamless construction for great durability.
- Thick polyurethane insulation safely keeps cold food below 41°F, hot food above 140°F for 4+ hours.
- Fully removable, gasketless door.
- Labeling area on door for adhering ID or routing labels.

Colors: Black (110), Dark Brown (131), Hot Red(158), Navy Blue (186), Slate Blue (401), Charcoal Gray (615).

UPC300 is covered by US Patent D786,607 S.



Recommended labeling with: 23SLINB250 2" x 3" StoresSafe® Labels.



New!

CODE	UPC300
EXTERIOR DIM. W x D x H	17" x 25¼" x 22¾"
INTERIOR DIM. W* x D x H	13¼" x 21" x 14"
UNIT WEIGHT	23.3 lbs.
FITS CAMDOLLY®	CD300, CD300H, CD300HB
LIST PRICE EACH	\$ 505.00

Case Pack: 1 InStock Colors: Dark Brown (131), Black (110). *Rail to Rail Temperature Maintenance Tools: 1210PW Camwarmer®, UPC300DIV ThermoBarrier® and CP1220 Camchiller®.

Hot — temperature loss averaging 3°F/hour.

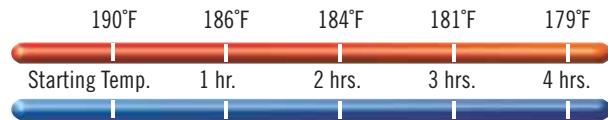

Cold — temperature gain averaging 1.5°F/hour.



UPC300 Holding Capacity

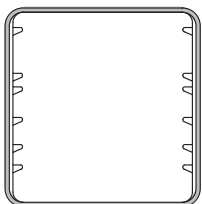

UPC300 rail configuration

DEPTH	GN 1/1	GN 1/2	GN 1/3
2½"	4	8	12
4"	3	6	9
6"	2	4	6
8"	1	2 + two 4"	3 + three 4"

Optional Accessories



CODE	CD300	CD300H
DESCRIPTION	Camdolly	Camdolly with Handles
EXTERIOR DIM.	25½" x 19¼" x 10½"	19" x 30½" x 36½"
INTERIOR DIM.	16⅞" x 23⅛"	17" x 23½"
LIST PRICE EACH	\$ 325.00	\$ 510.00

Case Pack: 1

Colors: Coffee Beige (157), Dark Brown (131), Black (110), Slate Blue (401).

TRANSPORTER CAPACITY GUIDE

Loading Examples for Cambro® Insulated Transporters

TOP LOADERS

UPC140-UPC180
UPCS140-UPCS180
UPCSS160

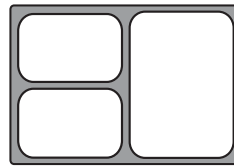

For a 3-course meal:
2 x GN 1/4
1 x GN 1/2
1 DIV12 divider bar
(approx. 14 meals)

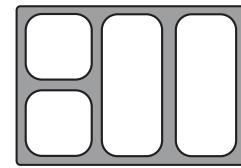

For a 4-course meal:
2 x GN 1/6
2 x GN 1/3
2 DIV12 divider bars
(approx. 14 meals)

TOP LOADERS

100 series
100MPC
UPC100

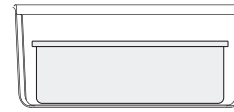
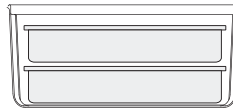
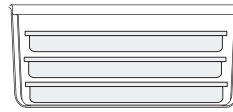

FRONT LOADERS

UPC300
1318CC
UPC600 (x2)
UPC1200 (x4)

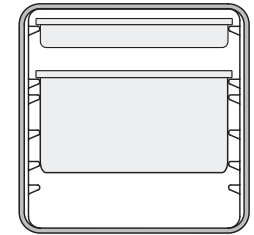
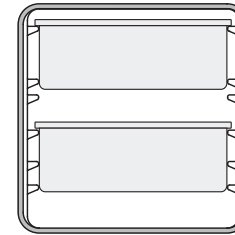
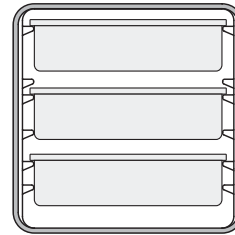
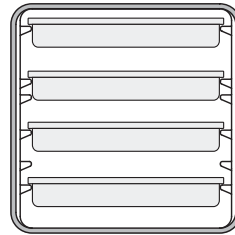

FRONT LOADERS

UPC400
UPCS400
UPCH400(2)
UPC800 (x2)
UPCH800(2) (x2)
UPC1600 (x4)
UPCH1600(2) (x4)

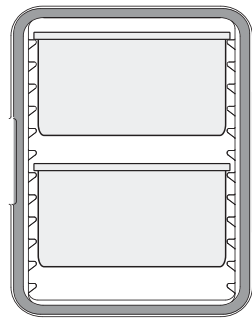
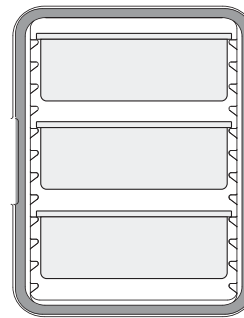
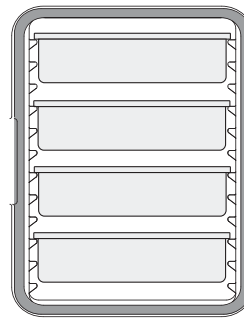
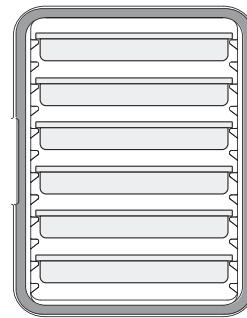

CAMCARRIERS® AND CAMCARTS® FOR SHEET PANS

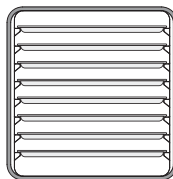

1318CC
1/2 size (x8)
sheet pans

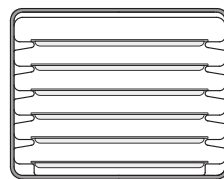

1826MTC
full-size (x6)
sheet pans
1826DTC (x4)

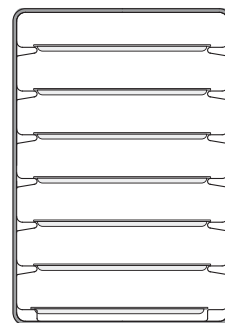

1826LTC3
full-size (x7)
sheet pans

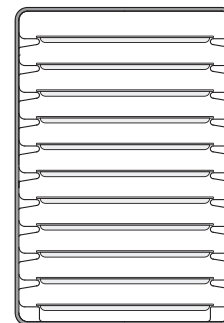

Camtherm Low
full-size (x11)
sheet pans
Camtherm Tall (x2)

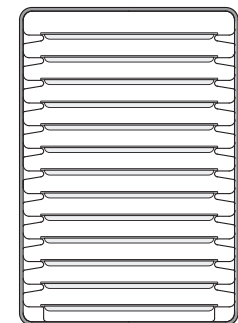

1826LTC
full-size (x13)
sheet pans

SUMMARY OF GN CONTAINER SIZES

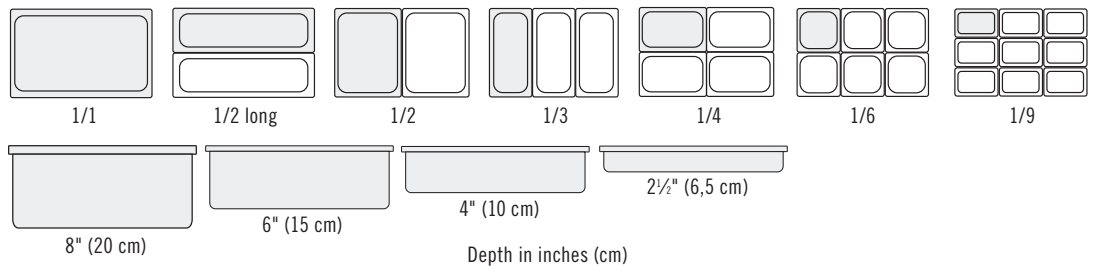

TEMPERATURE MAINTENANCE TOOLS



Camchiller®

- An easy-to-use, cold food holding temperature tool.
- Extend cold holding time or enhance safe holding below 41°F when frequent access is required.
- Freeze first then use to pre-chill cabinet before loading.



Cold — temperature gain averaging 1.5°F/hour.

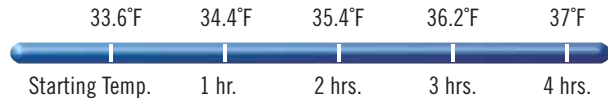

CODE	CP1220 (GN FULL SIZE)	CP1210 (GN HALF SIZE)	CP814 (8 x 14 CAMCHILLER)
FITS INTO	Insulated Transporters: UPC300, 300MPC, 1318CC, 1318MTC, UPC400, UPCS400, UPC100, UPC600, UPC800, UPC1200, UPC1600, UPCSS160 Camcruisers®: CVC72*, CVC724* Combo Carts™: All Models CamKiosk®*: All Models	Insulated Transporters: UPC300, 300MPC, 1318CC, 1318MTC, UPC140, UPC160, UPC180, UPC400, UPCS400, UPC600, UPC800, UPCS140, UPCS160, UPCS180 Camcruisers®: CVC72*, CVC724* CamKiosk®*: All Models	Food Boxes: 12189CW, 12189P, 12186CW, 12186P Camcruisers®: CVC55, CVC72*, CVC724* CamKiosk®*: All Models
DIMENSIONS L x W x H	20 ⁷ / ₈ " x 12 ⁷ / ₈ " x 1 ¹ / ₂ "	10 ³ / ₈ " x 12 ³ / ₄ " x 1 ¹ / ₂ "	14" x 8" x 1 ¹ / ₂ "
LIST PRICE EACH	\$ 140.00	\$ 73.00	\$ 73.00

Case Pack: 1 Color/InStock Color: Cold Blue (159). *Top wells only.

ThermoBarrier®

- A highly valuable yet economical temperature maintenance tool for caterers.

- Use to minimize empty space and food temperature loss within a partially loaded compartment.



CODE	^{New!} UPC300DIV	300DIV	400DIV	1200DIV	1600DIV
FITS INTO	UPC300, 1318CC	300MPC, 1318MTC, UPC600	UPC400, UPC800, UPC400SP, UPCS400, UPC800SP	UPC1200, CVC72, CVC724	UPC1600, CamKiosk
DIMENSIONS L x W x H	20 ⁷ / ₈ " x 12 ¹⁵ / ₁₆ " x 1"	20 ¹³ / ₁₆ " x 12 ¹⁵ / ₁₆ " x 1"	21 ¹ / ₄ " x 13" x 1 ¹ / ₂ "	20 ⁷ / ₈ " x 12 ⁷ / ₈ " x 1 ³ / ₈ "	20 ⁷ / ₈ " x 13 ³ / ₈ " x 1 ¹ / ₂ "
COLOR	Charcoal Gray (615)	Coffee Beige (157)	Gray (180)	Dark Brown (131)	Slate Blue (401)
CASE PACK	1	1	1	2	2
LIST PRICE EACH	\$ 78.00	\$ 78.00	\$ 78.00	\$ 89.00	\$ 89.00

InStock Models: UPC300DIV and 400DIV.

Camwarmer®

- Added insurance to keep hot foods hot during holding and transporting.
- Keep in cabinet with hot foods to extend holding time or enhance safe holding above 140°F (65°C) when frequent access is required.



CODE	1210PW
FITS INTO	UPC300, 300MPC, 1318CC, 1318MTC, UPC400, UPCS400, UPC600, UPC800
DIMENSIONS L x W x H	13 ³ / ₄ " x 10 ⁷ / ₈ " x 1 ¹ / ₆ "
LIST PRICE EACH	\$ 200.15

Case Pack: 1 InStock Color: Granite Gray (191).



UPC400 with Camwarmer.
Two Camwarmers recommended per cavity. Place on bottom rail and store hot food above.



TEMPERATURE MAINTENANCE – OPTIMIZE FOOD HOLDING PERFORMANCE

Camchiller® – GN Full Size and Half Size

- Use to:
 - Pre-chill cabinet cavity.
 - Hold packaged food in food pan wells (Half Size Only).
 - Maximize cold food holding.
 - Minimize open cavity space.
- Easy to use:
 1. Freeze flat for 8 hours.
 2. Slide one or two on top rails and pre-chill cavity 15-20 minutes.
 3. Load in pans of pre-chilled food below Camchiller. (A)
 4. Move pans and Camchiller down as food is removed. (B)

COLD HOLDING

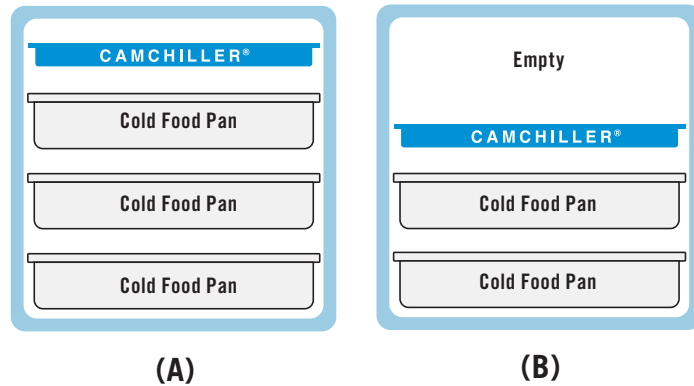

ThermoBarrier® – Full Size

- Use to:
 - Hold hot and cold food in same cabinet cavity.
 - Minimize open cavity space.
- Easy to use:
 1. Slide between hot food on top and cold food on bottom. (A)
 2. Slide under hot food loaded in upper cavity space. (B)
 3. Slide above cold food loaded into lower cavity space. (C)

HOT AND COLD HOLDING

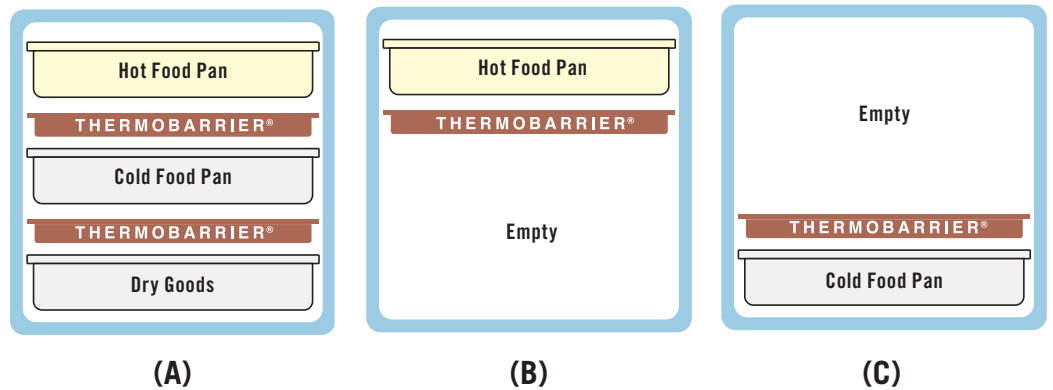

Camwarmer® – Half Size

- Use to:
 - Pre-heat cabinet cavity.
 - Maximize hot food holding.
 - Minimize open cavity space.
- Easy to use:
 1. Heat in 350°F (180°C) oven for 45 minutes.
 2. Slide two Camwarmers on bottomrails and pre-heat cavity 15-20 minutes. (or place on high heat food pan lid or sheet pan)
 3. Load in pans of pre-heated food above Camwarmers. (A)
 4. Move pans and Camwarmers up as food is removed. (B)

HOT HOLDING

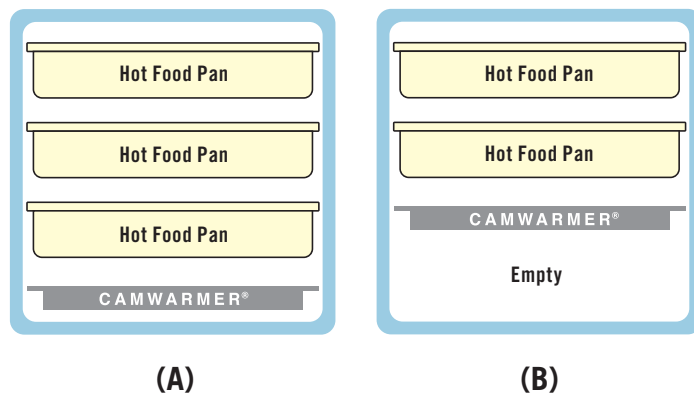

INSULATED FOOD SERVERS (NON-ELECTRIC)



Single GN Food Pan, Top-Loading Carriers

- Top-loading food pan carriers hold, transport and serve a single full-size pan of hot or cold food.
- Sturdy and durable, seamless polyethylene or polypropylene with thick foam insulation.
- Molded-in handles on all four sides for easy carrying and handling.
- 100 Series interstacks within the series and 240MPC stacks only with 240MPCs.
- Use with divider bars to hold multiple fractional pans.
- Pans are easy to remove using finger notches.
- Carriers interlock and stack for transporting and storing.

UPCS Colors: Dark Brown (131), Coffee Beige (157), Speckled Gray (480), Black (110).

MPC and MPCHL Colors: Navy Blue (186), Slate Blue (401), Coffee Beige (157), Dark Brown (131), Brick Red (402), Kentucky Green (519), Black (110), Hot Red (158).

UPC Colors: Slate Blue (401), Dark Brown (131), Black (110), Granite Gray (191), Granite Green (192).

See Food Pan Section and Camdolly Section for pricing and ordering information.

Note: Place food pans on rails. Pans should not be placed on the floor of a Camcarrier® cavity.

Note: Best results will be achieved by loading food pans between 180° to 190°F (82° to 88°C). Loading metal food pans over 250°F (121°C) may result in damage to the carrier.



Hot — temperature loss averaging 3°F/hour.

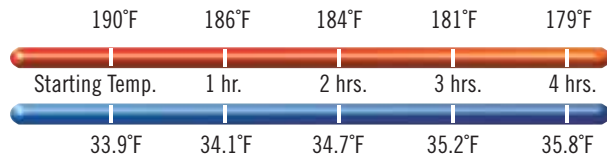

Cold — temperature gain averaging 1.5°F/hour.

UPC140



UPC160
Shown with dividers and fractional sized food pans.

UPC100
No divider bars available for UPC100.



Camcarrier®

One-piece, seamless polyethylene construction, airtight removable gasket and sturdy plastic latches.

CODE	240MPC	100MPCHL
COMPARTMENT CAPACITY	1 half size 2½" deep pan or 1 half size 4" deep pan	1 full size 8" deep pan
EXTERIOR DIM. W x D x H	16½" x 13⅞" x 7½"	26¾" x 18" x 15½"
INTERIOR DIM. W x D x H	13⅞" x 11⅙" x 4"	21¾" x 13¾" x 8"
BULK CAPACITY*	6.3 qts.	40 qts.
FITS CAMDOLLY®	CD1420	CD100, CD100H, CD100HB
LIST PRICE EACH	\$ 300.00	\$ 540.00

Case Pack: 1 *Without using food pans. 240MPC and 100MPCHL No Divider Bar.

INSULATED FOOD SERVERS (NON-ELECTRIC)

S-Series

Durable polypropylene construction, built in seal and wide, nylon latches.
Contemporary appearance and superior holding performance at an economical price.



CODE	UPCS140	UPCS160*	UPCS180
COMPARTMENT CAPACITY	1 full size 4" deep pan	1 full size 6" deep pan	1 full size 8" deep pan
EXTERIOR DIM. W x D x H	25 $\frac{1}{8}$ " x 17 $\frac{1}{8}$ " x 8 $\frac{1}{2}$ "	25 $\frac{1}{8}$ " x 17 $\frac{1}{8}$ " x 10 $\frac{1}{4}$ "	25 $\frac{1}{8}$ " x 17 $\frac{1}{8}$ " x 12"
FITS CAMDOLLY®	CD160	CD160	CD160
LIST PRICE EACH	\$ 270.00	\$ 280.00	\$ 300.00

Case Pack: 1 *UPCS160 Cannot be used with Camchiller.

Ultra Pan

One-piece, seamless polyethylene construction, airtight removable gasket and wide, nylon latches.



CODE	UPC140	UPC160	UPC180
COMPARTMENT CAPACITY	1 full size 4" deep pan	1 full size 6" deep pan	1 full size 8" deep pan
EXTERIOR DIM. W x D x H	24 $\frac{1}{4}$ " x 17 $\frac{1}{8}$ " x 8 $\frac{1}{4}$ "	24 $\frac{1}{4}$ " x 17 $\frac{1}{8}$ " x 10 $\frac{1}{4}$ "	24 $\frac{1}{4}$ " x 17 $\frac{1}{8}$ " x 12"
FITS CAMDOLLY	CD100H, CD1826HB, CD160	CD100H, CD1826HB, CD160	CD100H, CD1826HB, CD160
LIST PRICE EACH	\$ 405.00	\$ 410.00	\$ 420.00

Case Pack: 1

Multiple Stackable GN Food Pans, Top-Loading Carriers

100 Series

Store and stack food pans or place packaged food directly in compartment.



CODE	100MPC	UPC100
COMPARTMENT CAPACITY	3 full size 2 $\frac{1}{2}$ " deep pans or 2 full size 4" deep pans or 1 full size 6" or 8" deep pan	3 full size 2 $\frac{1}{2}$ " deep pans or 2 full size 4" deep pans or 1 full size 6" or 8" deep pan
EXTERIOR DIM. W x D x H	26 $\frac{3}{4}$ " x 18" x 15"	26 $\frac{5}{8}$ " x 18" x 15 $\frac{3}{4}$ "
INTERIOR DIM. W x D x H	21 $\frac{3}{4}$ " x 13 $\frac{3}{4}$ " x 8"	22 $\frac{1}{4}$ " x 13" x 8"
BULK CAPACITY*	40 qts.	40 qts.
FITS CAMDOLLY	CD100H, CD1826MTC, CD100HB, CD1826MTCHB, CD100, CD2028	CD100H, CD1826MTC, CD100HB, CD1826MTCHB, CD100, CD2028
LIST PRICE EACH	\$ 430.00	\$ 455.00

Case Pack: 1 *Without using food pans. 100MPC and UPC100 No Divider Bar.

Accessories

CODE	OVERALL EXTERIOR	LIST PRICE EA.
Divider Bars for Food Pans		
DIV12	12 $\frac{3}{4}$ " length	\$ 4.20
Case Pack: 3	Colors: White (148), Clear (135).	





New!

CAM GOBOX® INSULATED LIGHTWEIGHT CARRIERS

Cambro's latest line of insulated transporters are ideal for caterers and foodservice operators looking for an ultra-lightweight transporter that offers superior temperature retention to protect food safety and excellent durability to withstand heavy commercial use, all at a budget-friendly price. Just take them and GO!

Thermal Insulation – Holds hot or cold food for many hours.

- **Lightweight** – Made of EPP (Expanded Polypropylene) – an eco-friendly, high-performance foam material.
- **Great Structural Strength** – capable of handling significant loads while maintaining its shape and form.

- **Excellent Energy Absorption** – can withstand substantial impact without damage.
- **Chemically Inert** – unaffected by oil, grease, and most chemicals.
- **Dishwasher safe.**
- **CFC-Free.**
- **100% Recyclable.**
- **Line your Cam GoBox with a Cambro GN Food Pan and Seal Cover for the ultimate food safety solution.** Cambro GN pans protect food and carrier to support HACCP compliance.

Note: Best results will be achieved by loading food pans between 180° to 190°F. Loading metal food pans over 250°F will result in damage to the carrier.



CAM GOBOX® INSULATED LIGHTWEIGHT CARRIERS



Hot Holding

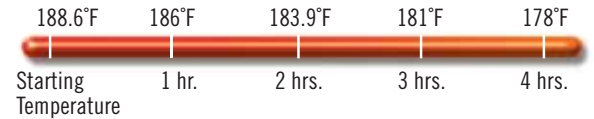

Cold Holding

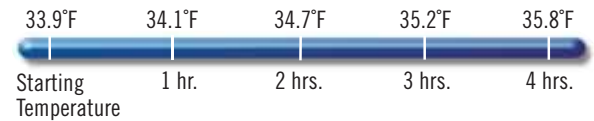

Using Cam GoBox carriers together with Cambro's Camwear®, polypropylene or high heat GN food pans creates the ideal food-safe, HACCP-compliant holding and transport system.



Ergonomic Handles

Comfortable handles allow easy and safe lifting of the Cam GoBox.



Stackability

Cam GoBoxes inter-stack and also stack with major competitive brands.



Easy Identification

A built-in label area keeps plastic menu tags (included for EPP300 and EPP400) in place for easy content identification or routing. StoreSafe Labels can also be used with Cam GoBoxes.



Easy Loading and Unloading

Interior wall recesses make loading and unloading easy for both GN 1/1 as well as 1/2 pans.



4-Sided Handling

Thoughtfully designed built-in handles along the top of the front loader units allow them to be easily carried from all four sides.

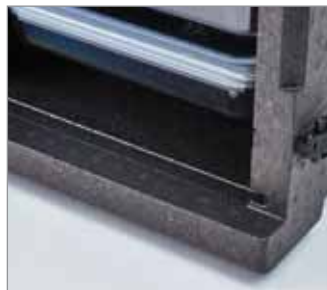

Drip-Resistant

Built-in condensation barrier helps front loaders to remain drip-resistant.



Gentle Open and Close

Beveled door edges ensure door can be easily closed and latched.



Full 270° Access

Durable hinges and latches allow the door to open 270° and remain open securely to the side of the front loader for easy access to products. Latches keep door securely closed during transport.

CAM GOBOX® INSULATED LIGHTWEIGHT CARRIERS



EPP260
 Top loader for 6" GN 1/2 pan
EXTERIOR DIM. L x W x H:
 15.4" x 13" x 10"
INTERIOR DIM. L x W x H:
 13" x 10.6" x 7.6"
UNIT WEIGHT: 1.37 lbs.
VOLUME: 17.9 qt.
LIST PRICE EACH: \$ 65.00
Case Pack: 1 **Color:** Black (110).



EPP280
 Top loader for 8" GN 1/2 pan
EXTERIOR DIM. L x W x H:
 15.4" x 13" x 12.4"
INTERIOR DIM. L x W x H:
 13" x 10.6" x 10"
UNIT WEIGHT: 1.54 lbs.
VOLUME: 23.6 qt.
LIST PRICE EACH: \$ 72.00
Case Pack: 1 **Color:** Black (110).



EPP160
 Top loader for 6" GN 1/1 pan
EXTERIOR DIM. L x W x H:
 23.5" x 15.7" x 10"
INTERIOR DIM. L x W x H:
 21.2" x 13.3" x 7.7"
UNIT WEIGHT: 2.4 lbs.
VOLUME: 37.5 qt.
LIST PRICE EACH: \$ 90.00
Case Pack: 1 **Color:** Black (110).

Exclusive inter-stacking design
 saves **30%** storage space!



EPP180
 Top loader for 8" GN 1/1 pan
EXTERIOR DIM. L x W x H:
 23.6" x 15.7" x 12.4"
INTERIOR DIM. L x W x H:
 21.2" x 13.3" x 10"
UNIT WEIGHT: 2.6 lbs.
VOLUME: 48.6 qt.
LIST PRICE EACH: \$ 108.00
Case Pack: 1 **Color:** Black (110).



EPP180S
 Inter-stacking top loader for
 8" GN 1/1 pan
EXTERIOR DIM. L x W x H:
 23.5" x 15.7" x 7.2" (top)
 23.1" x 13.2" x 13.9" (bottom)
INTERIOR DIM. L x W x H:
 21.2" x 13.3" x 6.6" (top)
 19.8" x 11.9" x 3.7" (bottom)
UNIT WEIGHT: 2.5 lbs.
VOLUME: 45.4 qt.
LIST PRICE EACH: \$ 108.00
Case Pack: 1 **Color:** Black (110).



EPP300
 Front loader for GN 1/1 Pan
EXTERIOR DIM. L x W x H:
 25.2" x 17.3" x 18.7"
INTERIOR DIM. L x W x H:
 21" x 13" x 14.6"
UNIT WEIGHT: 7 lbs.
VOLUME: 63.4 qt.
LIST PRICE EACH: \$ 375.00
Case Pack: 1 **Color:** Black (110).



EPP400
 Front loader for GN 1/1 Pan
EXTERIOR DIM. L x W x H:
 25.2" x 17.3" x 24.6"
INTERIOR DIM. L x W x H:
 21" x 13" x 20.7"
UNIT WEIGHT: 8.6 lbs.
VOLUME: 90.9 qt.
LIST PRICE EACH: \$ 432.00
Case Pack: 1 **Color:** Black (110).

Optional Accessories



CP2632
 Camchiller® fits GN 1/2 Cam GoBoxes
DIMENSIONS L x W x H:
 12.8" x 10.4" x 1.2"
UNIT WEIGHT: 3.9 lbs.
LIST PRICE EACH: \$ 72.00
Case Pack: 1 **Color:** Glacier Blue (443).



CP3253*
 Camchiller® fits GN 1/1 Cam GoBoxes
DIMENSIONS L x W x H:
 20.9" x 12.8" x 1.2"
UNIT WEIGHT: 8.6 lbs.
LIST PRICE EACH: \$ 105.00
Case Pack: 1 **Color:** Glacier Blue (443).



HP3253*
 Camwarmer® fits GN 1/1 Cam GoBoxes
DIMENSIONS L x W x H:
 20.9" x 12.8" x 1.2"
UNIT WEIGHT: 7.2 lbs.
LIST PRICE EACH: \$ 142.00
Case Pack: 1 **Color:** Fire Red (444).



EPP3253DIV
 ThermoBarrier® fits EPP300 & EPP400
DIMENSIONS L x W x H:
 20.9" x 12.9" x 1.6"
UNIT WEIGHT: 0.8 lbs.
LIST PRICE EACH: \$ 35.00
Case Pack: 1 **Color:** Black (110).



CD3253EPP
 Camdolly® fits GN 1/1
 Cam GoBoxes, 4 swivel casters, two
 with breaks
UNIT WEIGHT: 9.9 Lbs.
LOAD CAPACITY: 551 Lbs.
LIST PRICE EACH: \$ 140.00
Case Pack: 1 **Color:** Hot Red (158).



EPPID5
 Plastic ID labels
LIST PRICE EACH: \$ 6.80
Case Pack: 1 **Color:** (000).

*Suitable for all front loader of
 UPC Series.

CAM GOBOX® CAPACITY GUIDE

All Cam GoBox carriers are designed with enough room to hold GN 1/2 and 1/1 pans along with Camwarmers® or Camchillers®, if desired.

Top Loaders

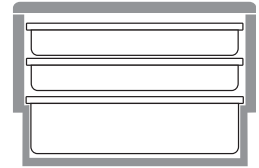
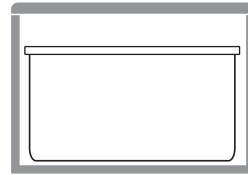
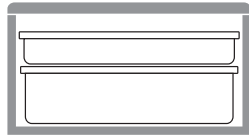

FOOD PAN DEPTH	EPP160 GN 1/1	TOTAL CAPACITY	EPP180 GN 1/1	TOTAL CAPACITY	EPP180S GN 1/1	TOTAL CAPACITY
2½"	3	26.9 qt.*	4	35.9 qt.*	2 + two 4"	31.7 qt.*
4"	1 + one 2½"	22.7	2	27.5	2	27.5
6"	1	20.6	1 + one 2½"	29.6	1 + one 2½"	26.6
8"	—	—	1 + one 2½"	36.6*	1	26.9

*Indicates use without temperature maintenance tools.

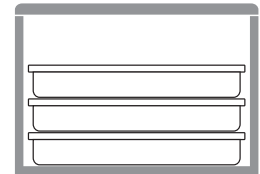
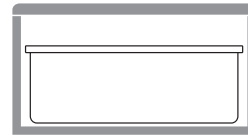

FOOD PAN DEPTH	EPP260 GN 1/2	TOTAL CAPACITY	EPP280 GN 1/2	TOTAL CAPACITY
2½"	3	13.5 qt.*	4	18 qt.*
4"	2	13.7*	2 + one 2½"	18.2*
6"	1	10.3	1 + one 2½"	14.8
8"	—	—	1	13.5

*Indicates use without temperature maintenance tools.

Front Loaders

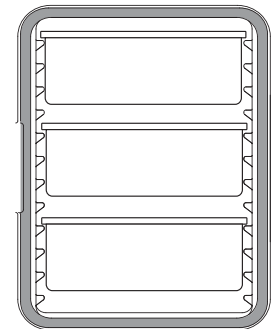
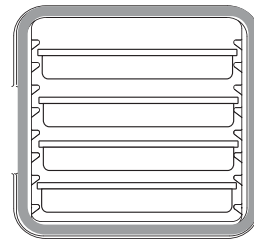

FOOD PAN DEPTH	EPP300 GN 1/1	TOTAL CAPACITY	EPP400 GN 1/1	TOTAL CAPACITY
2½"	4	35.9 qt.	6	35.9 qt.*
4"	3	41.2*	4	54.9*
6"	1 + two 2½"	38.6	3	61.8*
8"	1 + one 2½"	35.9	2	35.9



Food Pan Capacity Guide

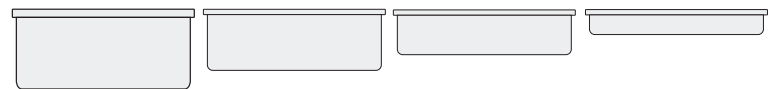

GN 1/1 FOOD PAN DEPTH	8"	6"	4"	2½"
SERVING CAPACITY PER PAN	26.9 qt.	20.6 qt.	13.7 qt.	9 qt.





Insulated Beverage Servers

- Use to hold, transport and serve hot or cold beverages for up to 4 hours.
- Pre-heat or pre-chill before use to guarantee maximum operational efficiency.
- Sturdy latches secure lids tightly and will never rust.
- Drip-proof recessed spigot for easy self-serve access.
- Molded-in metal backing plates Prevents latches from breaking away from the container.

INSULATED BEVERAGE SERVERS



Insulated Beverage Servers

UC1000 covered by U.S. Patent D 403,916.



- Stack units on riser to fill large cups or coffee pots.
- Stack interlocking ensures stable stacking during transport and storage.

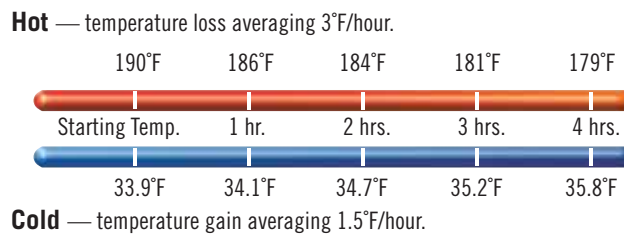

Stacking options:

- 100LCD with 100LCD
- All 250, 350 and 500 units
- UC1000 and 1000LCD



Camtainer Cover

Durable and attractive covers dress up and extend the life of your Camtainers.

Personalization available: \$15.00 NET per cover, less than 12 covers. 12 or more, FREE! Contact your Cambro representative for more details.

(Models for covers on next page.)



Vent Cap

Equalizes pressure. Makes opening the container much easier.



Recessed Faucet

Accommodates larger cups. Allows even dispensing and eliminates drips. Two positions: One for continuous pouring and one for individual dispensing.



Molded-in Metal Backing Plates

Prevents latches from breaking away from the container.



Ultra Camtainers®

Feature wide nylon latches which are easy to open and close with one hand.



Camtainers®

Feature sturdy plastic latches that secure lids tightly and will never rust.

INSULATED BEVERAGE SERVERS



Camtainers®

The standard for many caterers. Four sturdy plastic latches on each unit open and close easily and will never rust.



CODE	100LCD	250LCD	500LCD	1000LCD	350LCD (SOUP)
CAPACITY	1½ gal.	2½ gal.	4¾ gal.	11¼ gal.	3⅝ gal.
7 OZ. CUPS	27	45	86	214	61
SPIGOT	YES	YES	YES	YES	—
EXTERIOR DIM. W x D x H	10⅝" x 11½" x 17¼"	9" x 16½" x 18⅝"	9" x 16½" x 24¼"	16¼" x 20¾" x 24¼"	9" x 16½" x 18⅝"
FITS CAMDOLLY®	CD1420	CD100H, CD1826H, CD300H, CD2020H, CD100HB, CD300HB, CD1826HB, CD2020HB, CD100, CD2020	CD100H, CD1826H, CD300H, CD2020H, CD100HB, CD300HB, CD1826HB, CD2020HB, CD100, CD2020	CD300H, CD1826H, CD2020H, CD100HB, CD300HB, CD1826MTCHB, CD300, CD2020	CD100H, CD1826H, CD300H, CD2020H, CD100HB, CD300HB, CD1826HB, CD2020HB, CD100, CD2020
LIST PRICE EACH	\$ 235.00	\$ 245.00	\$ 280.00	\$ 430.00	\$ 240.00
CAMTAINER COVER	—	250LDCVCR: \$ 130.00	500LDCVCR: \$ 130.00	1000LDCVCR: \$ 130.00	—

Case Pack: 1 **Colors:** Navy Blue (186), Slate Blue (401), Coffee Beige (157), Dark Brown (131), Brick Red (402), Kentucky Green (519), Black (110), Hot Red (158). **InStock Colors:** Dark Brown (131), Black (110). **Cover Color:** Black (110). Venting plug is covered by US Patent D 553,717 S.

Ultra Camtainers®

A contemporary line, featuring two wide nylon latches per unit that are easy to open and close.



CODE	UC250	UC500	UC1000
CAPACITY	2¾ gal.	5¼ gal.	10½ gal.
7 OZ. CUPS	50	96	192
EXTERIOR DIM. W x D x H	11¾" x 16¾" x 19¾"	11¾" x 16¾" x 26⅝"	16¼" x 20½" x 25¾"
FITS CAMDOLLY	CD100H, CD1826H, CD300H, CD100HB, CD300HB, CD100	CD100H, CD1826H, CD300H, CD100HB, CD300HB, CD100	CD300H, CD1826H, CD2020H, CD100HB, CD300HB, CD1826MTCHB, CD300, CD2020
LIST PRICE EACH	\$ 290.00	\$ 325.00	\$ 440.00
CAMTAINER COVER	UC250CVR: \$ 130.00	UC500CVR: \$ 130.00	UC1000CVR: \$130.00

Case Pack: 1 **Colors:** Navy Blue (186), Slate Blue (401), Coffee Beige (157), Dark Brown (131), Brick Red (402), Kentucky Green (519), Black (110), Granite Gray (191), Granite Green (192), Granite Sand (194). **InStock Colors:** Dark Brown (131), Black (110), Granite Gray (191). Venting plug is covered by US Patent D 553,717 S. **Cover Color:** Black (110).

Camserver®

- A front-of-house beverage server for hot or cold beverages that does not require canned heating.
- Double-wall polyethylene shell with thick foam insulation retains temperatures for hours.

Colors: Black (110), Dark Taupe (417), Granite Gray (191).



Convenient top-fill opening for fast replenishment without removing lid.

CSR3
Shown in
Dark Taupe.



CSR5
Shown in Black.

Height is approximately 7"
from counter to spigot.

CODE	OVERALL DIMENSIONS W x D x H	CAPACITY	7 OZ. CUPS	LIST PRICE EA.
CSR3	13¼" x 18¼" x 23½"	3 gal.	54	\$ 505.00
CSR5	13¼" x 18¼" x 28"	5	91	525.00

Case Pack: 1

INSULATED BEVERAGE SERVERS ACCESSORIES

Handwash Accessories

- Convenient and economical way to meet health department hand washing requirements on or off premise.
- Attaches to 2.5-gallon (9.5 L) or 5-gallon (19 L) Camtainers® or Ultra Camtainers®.
- Includes four "Handwash Only" labels and an Easy Serve Dispenser lever.

Handwash Accessory Stocking Colors:
Dark Brown (131), Black (110).

Easy Serve Dispenser Color:
Black (110).

Riser Colors: See optional accessories with Camtainers.

Pail with Bail Color: White (148).

Handwash Accessory is covered by the following U.S. Patents: D 506,634 S, D 506,899 S & D 548, 980 S.



Shown with 500LCD Camtainer.



CODE	HWAPR	HWATD
DESCRIPTION	With paper towel roll holder	With multi-fold paper towel dispenser
FITS	250LCD, 500LCD, UC250, UC500	250LCD, 500LCD, UC250, UC500
LIST PRICE EACH	\$ 275.00	\$ 360.00

Optional Handwash Accessories

CODE	DESCRIPTION	LIST PRICE EA.
R500LCD	Riser	\$ 99.00
PWB22	Pail with Bail	27.55
LCDES	Easy serve dispenser	17.05

R500LCD, PWB22, LCDES are NSF listed.

Optional Accessories



CODE	R500LCD	R1000LCD	LCDCH	LCDCH10	LCDES
DESCRIPTION	Riser	Riser	Condiment holder	Condiment holder	Easy serve dispenser
EXTERIOR DIM. W x D x H	9 ³ / ₈ " x 16 ¹ / ₄ " x 4 ³ / ₁₆ "	15 ³ / ₈ " x 19 ¹ / ₂ " x 4 ¹ / ₂ "	8 ³ / ₄ " x 16 ¹ / ₂ " x 5"	16" x 20" x 4 ¹³ / ₁₆ "	—
FITS	250LCD, 500LCD, UC250, UC500	1000LCD, UC1000	250LCD, 500LCD, UC250, UC500	1000LCD, UC1000	LCD spigots, UC spigots
LIST PRICE EACH	\$ 99.00	\$ 110.00	\$ 89.00	\$ 130.00	\$ 17.05

Case Pack: 1 Colors: Coffee Beige (157), Dark Brown (131), Black (110). Easy Serve Dispenser Color: Black (110).

BEVERAGE SERVICE CARTS

- Ideal for breakfast, coffee or snack service.
- Use top counter to hold Cambro Beverage Servers, Versa Organizer Bins or Display Trays with Covers for food.
- Store drinkware, additional food items or other supplies in open compartment.
- Insulated cabinets hold hot or cold food in full, 1/2 or 1/3 size food pans or on Cambro Metric Camtrays® (3253).

Colors: Slate Blue (401), Granite Gray (191), Granite Green (192).

See Organizer section for more information on Organizer Bins.

See Beverage Server section for more information.

Wire Rack Color: Silver (000).

6" Casters: 2 fixed, 2 swivel, 1 with brake.



Beverage Service Cart is designed to hold Beverage Containers at point of service only. A dolly or hand truck with safety strap is recommended for moving Beverage Containers over longer distances or uneven surfaces.



MDC24F
Shown in Granite Gray (191).

CODE	EXTERIOR DIM. L x W x H	CASE PACK	LIST PRICE EA.
MDC24F	44½" x 30" x 44"	1	\$ 2,575.00
MDC24	44½" x 30" x 44"	1	2,575.00
OPTIONAL ACCESSORIES			
Organizer Bin			
5412CBP	12" x 5" x 4¼"	12	9.95
Camtainer®			
100LCD	10¾" x 11¾" x 17¼"	1	235.00
Wire Rack			
MDC24R	23" x 17" x 14"	1	145.00
Camchiller®			
CP1220	20 ¹³ / ₁₆ " x 12 ⁷ / ₈ " x 1½"	1	140.00

The use of racks in the MDC24 and MDC24F carts will allow the following configuration of pans or trays, per compartment:

DESCRIPTION	FULL (1/1)	HALF (1/2)	THIRD (1/3)
2½" Pans	(4) 12CW	(8) 22CW	(12) 32CW
4" Pans	(3) 14CW	(6) 24CW	(9) 34CW
6" Pans	(2) 16CW	(4) 26CW	(6) 36CW
8" Pans	(1) 18CW*	(2) 28CW*	(3) 38CW*
Metric Camtrays®	(10) 3253	—	—

*With room for 2½" or 4" pan above 8" pan.

Compartment Dimensions:

Shelf Compartment:	W 37 ¹⁵ / ₁₆ "	D 25 ⁵ / ₈ "	H 10"
Holding Compartments:	W 17 ⁷ / ₁₆ "	D 23 ³ / ₈ "	H 14 ¹ / ₈ "

Venting plug is covered by U.S. Patent D 553,717S.



MDC24, shown in Granite Green (192), has recessed top that holds 3 each 1 gallon Camtainers and stacked Condiment Bins & Wire Rack with 3253 trays.



MDC24R Wire Rack

Wire Rack (sold separately) to organize pans and trays in the cart. Rack holds Full, 1/2 and 1/3 size Food Pans and 3253 trays. When placed in cart's holding compartment, the rack allows room on either side for CP1220 Camchillers®.

CAMDOLLIES® FOR INSULATED BEVERAGE SERVERS AND CARRIERS

With Handles



CD100H

EXTERNAL DIM. W x D x H:
19½" x 33½" x 36¼"

INTERIOR DIM. W x D:
17⅝" x 26⅜"

CAPACITY: 350 lbs.

CASTER TYPE: A

FITS: 250LCD, 350LCD, 500LCD, UC250, UC500, 100MPCHL, UPC140, UPC160, UPC180, 100MPC, 300MPC, UPC100, UPC300, UPCS140, UPCS160, UPCS180, UPCS160

LIST PRICE EACH: \$ 520.00



CD300H

EXTERNAL DIM. W x D x H:
19" x 30½" x 36½"

INTERIOR DIM. W x D:
17" x 23½"

CAPACITY: 350 lbs.

CASTER TYPE: A

FITS: 1000LCD, UC1000, UPC300, 300MPC, 1318CC, 1318MTC, 250LCD, 350LCD, 500LCD, UC250, UC500, UPCS140, UPCS160, UPCS180, UPCS160

LIST PRICE EACH: \$ 510.00



CD1826H

EXTERNAL DIM. W x D x H:
20" x 31½" x 38¼"

INTERIOR DIM. W x D:
18" x 26"

CAPACITY: 300 lbs.

CASTER TYPE: A

FITS: 250LCD, 350LCD, 500LCD, 1000LCD, UC250, UC500, UC1000, 100MPC, 300MPC, UPC300, UPCS140, UPCS160, UPCS180, UPCS160

LIST PRICE EACH: \$ 550.00



CD1826MTC

EXTERNAL DIM. W x D x H:
23⅝" x 35⅝" x 36⅜"

INTERIOR DIM. W x D:
21⅝" x 28⅜"

CAPACITY: 350 lbs.

CASTER TYPE: A

FITS: 100MPC, UPC100, UPC400, 1826MTC

LIST PRICE EACH: \$ 600.00



CD2020H

EXTERNAL DIM. W x D x H:
22⅝" x 25⅝" x 36⅜"

INTERIOR DIM. W x D:
20⅝" x 20⅝"

CAPACITY: 350 lbs.

CASTER TYPE: B

FITS: 250LCD, 350LCD, 500LCD, 1000LCD, UC1000

LIST PRICE EACH: \$ 470.00



Big Rear Wheels



CD100HB

EXTERNAL DIM. W x D x H:
23⅝" x 32⅝" x 36⅝"

INTERIOR DIM. W x D:
18" x 27"

CAPACITY: 350 lbs.

CASTER TYPE: C

FITS: 250LCD, 350LCD, 500LCD, 1000LCD, UC250, UC500, UC1000, 100MPCHL, 100MPC, UPC100, UPC300, 300MPC

LIST PRICE EACH: \$ 630.00



CD300HB

EXTERNAL DIM. W x D x H:
23½" x 29⅝" x 36½"

INTERIOR DIM. W x D:
17" x 23⅝"

CAPACITY: 350 lbs.

CASTER TYPE: C

FITS: 250LCD, 350LCD, 500LCD, 1000LCD, UC250, UC500, UC1000, 300MPC, 1318MTC, UPC300, 1318CC, UPCS140, UPCS160, UPCS180, UPCS160

LIST PRICE EACH: \$ 605.00



CD1826HB

EXTERNAL DIM. W x D x H:
23½" x 32½" x 36½"

INTERIOR DIM. W x D:
18½" x 26¼"

CAPACITY: 300 lbs.

CASTER TYPE: C

FITS: 250LCD, 350LCD, 500LCD, UPC140, UPC160, UPC180, 300MPC, 1318MTC, UPC300, 1318CC, UPCS140, UPCS160, UPCS180, UPCS160

LIST PRICE EACH: \$ 680.00



CD1826MTCHB

EXTERNAL DIM. W x D x H:
27⅝" x 35" x 36¾"

INTERIOR DIM. W x D:
21⅝" x 28⅝"

CAPACITY: 350 lbs.

CASTER TYPE: C

FITS: 1000LCD, UC1000, 100MPC, UPC100, UPC400, 1826MTC

LIST PRICE EACH: \$ 755.00



CD2020HB

EXTERNAL DIM. W x D x H:
26¼" x 26½" x 36⅝"

INTERIOR DIM. W x D:
20½" x 20⅝"

CAPACITY: 350 lbs.

CASTER TYPE: C

FITS: 250LCD, 350LCD, 500LCD

LIST PRICE EACH: \$ 605.00



CAMDOLLIES® FOR INSULATED BEVERAGE SERVERS AND CARRIERS

Without Handles



CD100
EXTERNAL DIM. W x D x H:
 19⁵/₈" x 28⁵/₈" x 10¹/₂"
INTERIOR DIM. W x D:
 17³/₁₆" x 26³/₈"
CAPACITY: 300 lbs.
CASTER TYPE: A
FITS: 250LCD, 350LCD, 500LCD,
 UC250, UC500, 100MPCHL, 100MPC,
 300MPC, UPC300, UPC100, UPCS140,
 UPCS160, UPCS180, UPCSS160
LIST PRICE EACH: \$ 325.00



CD160
EXTERNAL DIM. W x D x H:
 16⁷/₁₆" x 24¹/₂" x 10³/₈"
INTERIOR DIM. W x D:
 14¹/₄" x 22¹/₄"
CAPACITY: 300 lbs.
CASTER TYPE: A
FITS: UPCS140, UPCS160, UPCS180,
 UPCSS160, UPC140, UPC160,
 UPC180
LIST PRICE EACH: \$ 325.00



CD300
EXTERNAL DIM. W x D x H:
 25¹/₂" x 19¹/₄" x 10¹/₂"
INTERIOR DIM. W x D:
 16⁷/₈" x 23¹/₁₆"
CAPACITY: 350 lbs.
CASTER TYPE: A
FITS: 1000LCD, UC1000, 300MPC,
 1318MTC, UPC300, 1318CC,
 UPCS140, UPCS160, UPCS180,
 UPCSS160
LIST PRICE EACH: \$ 325.00



CD400
EXTERNAL DIM. W x D x H:
 21¹/₁₆" x 28⁵/₈" x 9"
INTERIOR DIM. W x D:
 18¹/₂" x 25⁵/₁₆"
CAPACITY: 300 lbs.
CASTER TYPE: A
FITS: UPCS400, UPC400
LIST PRICE EACH: \$ 360.00



CD1420
EXTERNAL DIM. W x D x H:
 16¹/₄" x 21³/₄" x 8⁵/₁₆"
INTERIOR DIM. W x D:
 13³/₈" x 19¹/₁₆"
CAPACITY: 350 lbs.
CASTER TYPE: B
FITS: 100LCD
LIST PRICE EACH: \$ 295.00



CD2020
EXTERNAL DIM. W x D x H:
 22¹/₂" x 22¹/₂" x 8¹/₄"
INTERIOR DIM. W x D:
 20³/₈" x 20³/₈"
CAPACITY: 300 lbs.
CASTER TYPE: B
FITS: 250LCD, 350LCD, 500LCD,
 1000LCD, UC1000
LIST PRICE EACH: \$ 300.00



CD2028
EXTERNAL DIM. W x D x H:
 21⁷/₈" x 30¹/₄" x 8¹/₄"
INTERIOR DIM. W x D:
 19¹/₂" x 27⁷/₈"
CAPACITY: 350 lbs.
CASTER TYPE: B
FITS: 100MPC, UPC100, 300MPC,
 UPC300, UPC400
LIST PRICE EACH: \$ 310.00



Camdolly® Colors:
 Coffee Beige (157), Dark Brown (131),
 Black (110), Slate Blue (401).

CD400 InStock Colors:
 Black (110), Dark Brown (131).

Caster Type:
(A) 5" Casters, 2 fixed, 2 swivel,
 1 with brake.
(B) 3" Casters, 4 swivel, no brakes.
(C) 10" Rear Big Wheels, 2 front 5" swivel
 casters, 1 with brake.

Optional Accessories



400STP (STRAP)
DIMENSION: 150" Long
LIST PRICE EACH: \$ 15.00

UTHSTP (STRAP)
DIMENSION: 200" long
LIST PRICE EACH: \$ 17.00



1826HAR (LIFTING HARNESS)
DIMENSION: 142" long
LIST PRICE EACH: \$ 90.00

MERCHANDISING EQUIPMENT

Versa Food Service System

Versa Food Bar® and Versa Work Table Ultra Series

Food Bar Accessories

Table Top Food Bars, Buffet Bars & Sneeze Guards

Sample Food Bar Set-ups

CamKiosk® System

Hand Sink Cart

Camcruiser® Vending Carts

Camshelving® Flex Station

Booster Seats & Versa Organizers

Portable CamBars®

SlidingLid™ Ice Caddies



VERSA FOOD SERVICE SYSTEM

The Versa Food Service System provides custom design without the custom price. This non electric, versatile, portable system keeps food cold for hours with either ColdFest® pans or Buffet Camchillers®. The system is made of durable all-weather material and is easy to clean. The Versa Food Service System offers countless configurations to fit any foodservice need.

- Ergonomic, molded-in handles on both sides ensure easy maneuvering.
- Versa Food Bar and Work Table both include a drain faucet that can be connected to a hose for drainage and easy cleaning.
- Add an end table to a Food Bar or Work Table to hold trays, condiments, or paper goods.

Versa Cart

- Join a Versa Cart with a Food Bar or Work Table for fast check-out and improved traffic flow.
- The Versa Cart includes an adjustable shelf, standard lockable drawer and convenient electrical access through the top of the cart and front design panel.
- Optional tray rails easily adjust to a lower height.
- Optional pull-out keyboard tray fits inside the drawer.



NSF
All components are fully compliant with NSF requirements.

Versa Food Service System is covered under U.S. Patent 9,084,498 B2



Versa Straight Connector and Versa Corner Connector

Easily and safely attach multiple components together to create a contiguous system and maximize space and merchandising options.



Versa Food Bar® Lighting Kit

Enhance your foodservice presentation with the LED lighting accessory. The light uses a 12 volt long-lasting battery that charges with an universal charger.

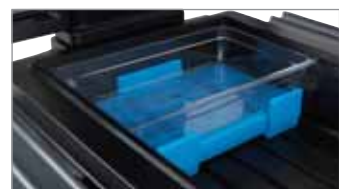

Buffet Camchillers®

Extend safe, cold holding time without ice. Dual-sided Buffet Camchillers hold 2½" (6,5 cm) and 4" (10 cm) pans. Fits in the Versa Food Bar, Versa Work Table and Table Top Food Bars.

VERSA FOOD SERVICE SYSTEM

Whether you're looking to maximize space, improve traffic flow, add merchandising space or create an upscale salad bar, the Versa Food Service System has you covered.



Versa Food Bar®

NSF
All components are fully compliant with NSF requirements.



44½" (114 cm) Wide



34" (86.4 cm) High
27" (68.6 cm) Low

32½" (83 cm) Wide



62¾" (160 cm) High

Standard height model.

Versa Work Table

- Perfect for a prep table, display, self-serve station or back bar.
- Attach a Work Table to a Food Bar to merchandise snacks and beverages.
- Matching well covers are included with each Versa Work Table.

VERSA BAR AND VERSA WORK TABLE ULTRA SERIES

- Now available with two secure storage cabinets that can hold up to 50 lbs. (22.7 kg) per compartment of non-perishable items.
- Preferred Salad Bar of Salad Bars to Schools Campaign.



NSF
All components are fully compliant with NSF requirements.

Storage Dimensions:
L 21½" x W 17½" x D 18" per cabinet.
Each cabinet is 3.92 cu. ft. (0,11 M³).

VERSA FOOD SERVICE SYSTEM

CODE	DESCRIPTION	OVERALL EXTERIOR DIMENSIONS L x W x H	FULL PAN SIZE CAPACITY	WELL INTERIOR DIMENSIONS L x W x H	LIST PRICE EA.
Versa Food Bars® - Standard Height					
VBR5	5' with standard casters	69" x 42½" x 62¾"	4	52⅝" x 21" x 7⅝"	\$ 3,275.00
VBRU5	5' with standard casters and storage	69" x 42½" x 62¾"	4	52⅝" x 21" x 7⅝"	4,175.00
VBRHD5	5' with heavy duty casters	69" x 42½" x 62¾"	4	52⅝" x 21" x 7⅝"	3,510.00
VBRUHD5	5' with heavy duty casters and storage	69" x 42½" x 62¾"	4	52⅝" x 21" x 7⅝"	4,410.00
VBR6	6' with standard casters	82" x 42½" x 62¾"	5	65⅝" x 21" x 7⅝"	3,410.00
VBRU6	6' with standard casters and storage	82" x 42½" x 62¾"	5	65⅝" x 21" x 7⅝"	4,460.00
VBRHD6	6' with heavy duty casters	82" x 42½" x 62¾"	5	65⅝" x 21" x 7⅝"	3,650.00
VBRUHD6	6' with heavy duty casters and storage	82" x 42½" x 62¾"	5	65⅝" x 21" x 7⅝"	4,700.00
Versa Food Bars - Low Height					
VBRL5	5' with standard casters	69" x 42½" x 55¾"	4	52⅝" x 21" x 7⅝"	3,275.00
VBRLHD5	5' with heavy duty casters	69" x 42½" x 55¾"	4	52⅝" x 21" x 7⅝"	3,510.00
VBRL6	6' with standard casters	82" x 42½" x 55¾"	5	65⅝" x 21" x 7⅝"	3,410.00
VBRLHD6	6' with heavy duty casters	82" x 42½" x 55¾"	5	65⅝" x 21" x 7⅝"	3,650.00
Versa Work Tables - Standard Height					
VBRT5	5' with standard casters	69" x 27" x 36¼"	4	52⅝" x 21" x 7⅝"	2,415.00
VBRUT5	5' with standard casters and storage	69" x 27" x 36¼"	4	52⅝" x 21" x 7⅝"	2,825.00
VBRTHD5	5' with heavy duty casters	69" x 27" x 36¼"	4	52⅝" x 21" x 7⅝"	2,655.00
VBRUTHD5	5' with heavy duty casters and storage	69" x 27" x 36¼"	4	52⅝" x 21" x 7⅝"	3,065.00
VBRT6	6' with standard casters	82" x 27" x 36¼"	5	65⅝" x 21" x 7⅝"	2,555.00
VBRUT6	6' with standard casters and storage	82" x 27" x 36¼"	5	65⅝" x 21" x 7⅝"	2,950.00
VBRTHD6	6' with heavy duty casters	82" x 27" x 36¼"	5	65⅝" x 21" x 7⅝"	2,795.00
VBRUTHD6	6' with heavy duty casters and storage	82" x 27" x 36¼"	5	65⅝" x 21" x 7⅝"	3,190.00
Versa Work Tables - Low Height					
VBRTL5	5' with standard casters	69" x 27" x 29¼"	4	52⅝" x 21" x 7⅝"	2,310.00
VBRTLHD5	5' with heavy duty casters	69" x 27" x 29¼"	4	52⅝" x 21" x 7⅝"	2,550.00
VBRTL6	6' with standard casters	82" x 27" x 29¼"	5	65⅝" x 21" x 7⅝"	2,450.00
VBRTLHD6	6' with heavy duty casters	82" x 27" x 29¼"	5	65⅝" x 21" x 7⅝"	2,690.00

Case Pack: 1

CODE	DESCRIPTION	OVERALL EXTERIOR DIMENSIONS W x D x H	LIST PRICE EA.
Versa Cart			
VCSWR	With dual tray rails and standard casters	52¼" x 32" x 43" (with tray rails up)	\$ 2,535.00
VCSWRHD	With dual tray rails and heavy duty casters	52¼" x 32" x 43¾" (with tray rails up)	3,195.00
VCS	With standard casters and no tray rails	32¼" x 32" x 43"	2,465.00
VCSHD	With heavy duty casters and no tray rails	32¼" x 32" x 43¾"	2,715.00
Connectors		L x W x H	
VBRC	Straight connector - food bar to food bar	27" x 19" x 4¼"	180.00
VBRC90	Corner connector - food bar to food bar	36" x 36" x 4¼"	310.00
VCS32CNT	Straight connector - cart to standard height food bar / work table	27" x 20⅝" x 3⅜"	320.00
VCSCNL	Straight connector - cart to low height food bar / work table	27" x 20⅝" x 8½"	390.00

Case Pack: 1

Versa Food Bar, Versa Work Table, Versa Cart, Connectors, Well Cover Color:

InStock Color



Black

Made to Order Colors for Versa Food Bar, Versa Work Table, Versa Cart, Connectors, Well Cover, Tray Rail and End Table:



Hot Red



Navy Blue



Kentucky Green

Made To Order Items Not Carried In Stock, Non-Returnable.

Tray Rail and End Table Colors Only:

InStock Colors



Granite Gray



**Black

**Made to order color for 1 Tray Rail and 1 End Table. These must be ordered in increments of 2 each. (Minimum of 2 each).

FOOD BAR ACCESSORIES

Every Accessory You Need

- Crock and salad bowl holders highlight and organize salads, condiments and dressings.
- Tray rails offer convenience for your patrons.

See Camwear® Food Pans and Crocks section for more information.

Versa Cart with Dual Tray Rails

(VCSWR & VCSWRHD): All orders receive the tray rails in Granite Gray (191). To choose a different color tray rail you must order the Versa Cart Without Rails (VCS or VCSHD) and the tray rails (VCS32R) separately.

Connector Colors: Black (110), Hot Red (158), Navy Blue (186), Kentucky Green (519).

Vinyl Cover Color: Opaque (000).

Sign Holder Color: Clear (152).

Buffet Camchiller® Color:

Cold Blue (159).

Divider Bar Colors: White (148), Clear (152).

Well Cover Colors: Black (110), Hot Red (158), Navy Blue (186), Kentucky Green (519).

Keyboard Tray Color: Black (110).

Crock, Salad Bowl Holders Colors: White (148), Granite Gray (191).

Versa Food Bar is covered under U.S. Patent D 615,323 S and D 620,730. Versa Food Bar Ultra Series is covered under U.S. Patent D702,066 S. Versa Cart is covered under U.S. Patent D 653,830 S. Buffet Camchiller is covered under U.S. Patent D 618,4765 S. All other parts patent pending.

*Items are not NSF Listed.

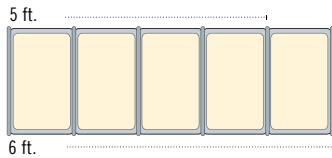

- 6 ft. models hold 5 full size pans with divider bars.
- 5 ft. models hold 4 full size pans with divider bars.

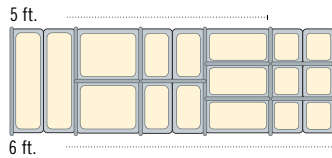

- Fractional size pans can be used in many variations with divider bars. Mix and match sizes to fit your needs.

Two salad bowl holder models available, SBH18 and SBH15. Crock holder, CPH3, holds 1.5 and 2.7 qt. crocks.

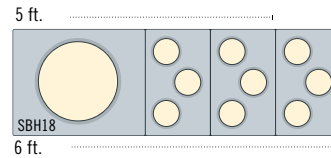

- 6 ft. models hold a salad bowl holder and 3 ea. crock holders.
- 5 ft. models hold a salad bowl holder and 2 ea. crock holders.

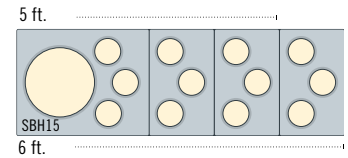

CODE	DESCRIPTION	OVERALL EXTERIOR DIMENSIONS	CASE PACK	LIST PRICE EA.
VBRR5	Tray rail for 5' - Versa Food Bar / Work Table	L 53" x W 11½" x H 4⅞"	1	\$ 435.00
VBRR6	Tray rail for 6' - Versa Food Bar / Work Table	L 66" x W 11½" x H 4⅞"	1	465.00
VCS32R	Tray rail for - Versa Cart	L 28" x W 11⅞" x H 5"	1	360.00
VBRTBL	End table for Versa Food Bar and Work Table	L 27" x W 22" x H 4½"	1	470.00
LED54LIGHTPKG*	Led light strip 54" long with brackets, battery and wall charger	L 54"	1	480.00
VBRCVR5*	Vinyl cover for 5' Versa Food Bar	L 73" x W 43½" x H 46"	1	310.00
VBRCVR6*	Vinyl cover for 6' Versa Food Bar	L 83" x W 43½" x H 46"	1	340.00
VBRTCVR5*	Vinyl cover for 5' Versa Work Table	L 70" x W 33½" x H 21"	1	165.00
VBRTCVR6*	Vinyl cover for 6' Versa Work Table	L 83" x W 33½" x H 21"	1	180.00
VCSCVR*	Vinyl cover for Versa Cart	L 42" x W 33" x H 36"	1	165.00
VBRSHTS*	Versa Food Bar sign holder	L 36" x W 6" x H 9¼"	1	265.00
DIV12	12" divider bars	L 12¾"	3	4.20
DIV20	20" divider bars	L 20⅞"	3	10.05
CPH3	Crock holder holds 1.5 & 2.7 qt.	L 12⅞" x W 20⅞"	1	73.00
SBH15	Salad bowl holder holds a 15" bowl and 3 crocks	L 25¾" x W 20⅞"	1	73.00
SBH18	Salad bowl holder holds an 18" bowl	L 25¾" x W 20⅞"	1	73.00
CPB1220	Buffet Camchiller for Versa Food Bars, Work Tables and table top food bars	L 18½" x W 12⅝" x H 4"	1	190.00
VBRWC	Versa well cover for Versa Food Bar / Work Table	L 20⅞" x W 13" x H 2"	1	135.00
VCS32KEYT	Versa Cart keyboard tray	L 20⅞" x W 10⅞" x H 2"	1	104.00

Versa Food Bar Well Cover InStock Color: Black (110).

TABLE TOP FOOD BARS, BUFFET BARS & SNEEZE GUARDS

Table Top Food Bars

- Turn a 4'-6' (122-183 cm) table into a double-sided self service buffet or beverage station.

- Thick, foam-insulated well keeps food cold for hours with Buffet Camchillers® or ice.
- Drain plug allows for quick and easy clean-up.

Buffet Bars

- Ideal for holding snacks and cold beverages.
- The Buffet Bar with Sneeze Guard is perfect for single-sided, self-serve buffets.

BUF48 and BUF72 are NSF listed.

BUF48 and FSG480 can be shipped by parcel carrier.

*NSF listed for non-direct food contact only.



4FBRTT Table Top Food Bar
Buffet Camchiller® available.



FSG480 Sneeze Guard
The Free Standing Sneeze Guard is the perfect showcase for salad or dessert items.



BUF48 Buffet Bar Base
Merchandises soft drinks on ice to increase beverage sales.



BBR480 Buffet Bar with Sneeze Guard

CODE	OVERALL EXTERIOR DIMENSIONS	FULL SIZE PAN CAPACITY	WELL INTERIOR DIMENSIONS	LIST PRICE EA.
Table Top Food Bars				
	L x W x H		L x W x D	
6FBRTT	71½" x 33¼" x 27"	5	62⅞" x 20⅞" x 6½"	\$ 1,785.00
5FBRTT	63½" x 33¼" x 27"	4	50⅞" x 20⅞" x 6½"	1,655.00
4FBRTT	51" x 33¼" x 27"	3	37¼" x 20⅞" x 6½"	1,500.00
Buffet Bars				
	L x W x H		L x W x D	
BUF72	67½" x 24" x 7"	5	62⅞" x 20⅞" x 5"	510.00
BUF48	41⅓" x 24" x 7"	3	37¼" x 20⅞" x 5"	440.00
Free Standing Sneeze Guards				
	L x W x H		L x W	
FSG720*	73⅞" x 16½" x 24½"	—	67½" x 15¼"	505.00
FSG480*	48" x 16½" x 24½"	—	42" x 15¼"	395.00
Buffet Bars w/Sneeze Guard				
	L x W x H		L x W x D	
BBR720	73⅞" x 24⅞" x 24½"	5	62⅞" x 20⅞" x 5"	990.00
BBR480	48" x 24⅞" x 24½"	3	37⅞" x 20⅞" x 5"	835.00

Case Pack: 1 Made to Order Colors: Black (110), Navy Blue (186), Kentucky Green (519), Hot Red (158).

SAMPLE FOOD BAR SET-UPS

Visit www.cambro.com/schools for food bar resources, best practices and free posters.



5 ft. (152 cm) model



6 ft. (183 cm) model

Fresh Food Bars Pre-packaged Breakfast



Rainbow Theme

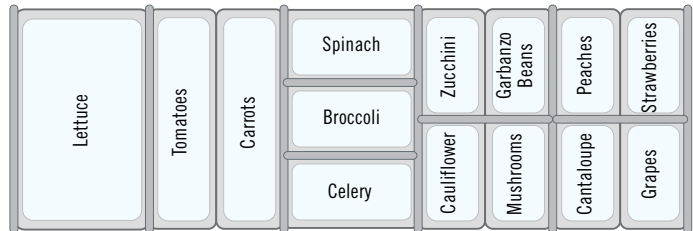

Fresh Food Bars Pre-packaged Lunch



Taco Theme

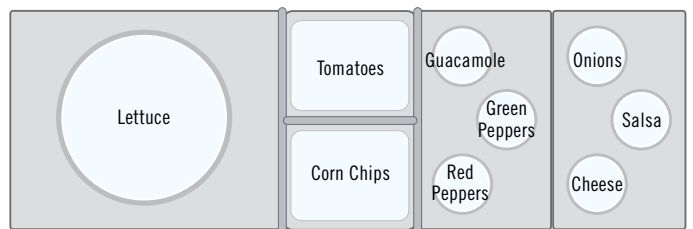

Chili Theme



Burger Theme

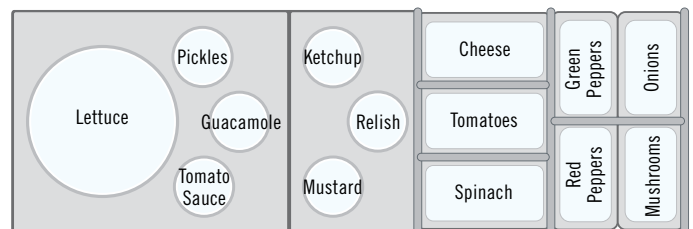

CAMKIOSK® SYSTEM – EVERY EVENT OR LOCATION IS AN OPPORTUNITY FOR PROFITS



- Build sales off premise and in non-traditional locations.
- Two insulated food storage cabinets maintain safe hot or cold food and/or beverage temperatures for hours.
- Use optional well covers to cover food pan wells and increase countertop space.
- Durable, all-weather polyethylene exterior with foam insulation will not crack, dent, bubble, chip, rust or break.
- Heavy duty 6" (15,2 cm) casters roll smoothly from kitchen to location then lock in place.

CAMKIOSK® CARTS



Conveniently located, lockable cash box (included) can also be kept in dry storage compartment.



Camchillers® keep packaged foods cold during transport and service. Place directly on top of food pan wells or at the top of the CamKiosk insulated holding cabinet.



4 well top with work space.



6 well top.



Telescoping poles enable canopy to lower 12" for quick and easy storage.



KVC854C Cart with 4 pan wells & canopy.

Cart Colors Canopy Color

186	Navy Blue	157	Beige
158	Hot Red		

Cart Colors Canopy Color

191	Granite Gray	519	Kentucky Green
192	Granite Green		
519	Kentucky Green		
426	Black Base with Granite Gray Top & Doors		

Personalize your CamKiosk Cart to promote your brand.

Canopy Trim and Top Panel
Call 714-230-4125 for a quote.

Front Display Panel
(Cruising Café® panel standard)
Set Up Charge per Panel \$ 135.00
Charge NET per Color 10.00

CODE	FULL SIZE PAN WELLS	OVERALL DIMENSIONS L x W x H	LIST PRICE EA.
CamKiosk Carts			
KVC854	4	85½" x 33½" x 70½"	\$ 7,660.00
KVC854C	4	85½" x 33½" x 94"	10,450.00
KVC856	6	85½" x 33½" x 70½"	7,660.00
KVC856C	6	85½" x 33½" x 94"	10,450.00

C: Canopy

Holding Capacity Per Compartment

Two holding cabinets store hot or cold food in Gastronorm Food Pans with Covers.

12 GN 1/1 full size 2½" deep pans or
8 GN 1/1 full size 4" deep pans or
6 GN 1/1 full size 6" deep pans or
4 GN 1/1 full size 8" deep pans or
4 each 2025 Camtrays or
8 each 3253 Camtrays

Well Cover Colors: Black (110), Hot Red (158), Navy Blue (186), Kentucky Green (519), Granite Gray (191), Granite Green (192).

6" Casters: 2 swivel, 2 swivel with brake.

Cutting Board Color: White (148).

Camchiller Color: Cold Blue (159).

ThermoBarrier Color: Slate Blue (401).



CODE	DESCRIPTION	DIMENSIONS L x W x H	CASE PACK	LIST PRICE EA.
Optional Accessories				
CB1220	Cutting board	21" x 13½" x ½"	1	\$ 42.00
CP814	8" x 14" Camchiller®	1½" x 8" x 14"	1	73.00
CP1210	Camchiller GN 1/2	10½" x 12¼" x 1½"	1	73.00
CP1220	Camchiller GN 1/1	20¾" x 12½" x 1½"	1	140.00
WCR1220	Well cover	21" x 13" x 2"	1	105.00
1600DIV	ThermoBarrier® insulated shelf	20½" x 13½" x 1½"	2	89.00

CAMKIOSK® HAND SINK CART, WORK STATION & EQUIPMENT STAND

Hand Sink Cart

- Self-contained, electric hand washing system can be used alone or with CamKiosk Cart.
- Run hot and cold water for up to 70 hand washings.
- Includes: double sink, two 5-gallon (19 L) fresh water tanks, two 7½-gallon (28,5 L) waste-water bins, hand soap dispenser and paper towel roll holder.
- Durable polyethylene will not crack, dent, bubble, chip or break.
- Hand Sink Cart is designed for hand washing. It contains no filter for purifying water for drinking.
- Faucet is compliant with lead-free regulations.

Colors: Granite Gray (191), Granite Green (192), Navy Blue (186), Hot Red (158), Kentucky Green (519), Black Base with Granite Gray Top & Doors (426).

6" Casters: 2 fixed, 2 swivel with brake.

Hand Sink Cart is covered by U.S. Patent 6,173,458 B1.



Water pump only.
Hand Sink Water Pump, UL & CE approved.



Water heater and water pump draw a maximum of 11.25 amps and 0.7 amps, respectively. Hand Sink Cart electrical system runs on an average 10 amps.

ADA faucet available. Contact Cambro Customer Service for information.



CODE	VOLTAGE	DIMENSIONS L x W x H	LIST PRICE EA.
KSC402	110	40 ³ / ₁₆ " x 33" x 45 ¹ / ₂ "	\$ 5,565.00

Case Pack: 1

Work Station

- Use to merchandise menu items, additional work space or to complete sales transactions.
- Large storage cabinet below is perfect for holding supplies.
- Extremely durable all-weather polyethylene will not crack, dent, bubble, chip, rust or break.

Colors: Granite Gray (191), Granite Green (192), Navy Blue (186), Hot Red (158), Kentucky Green (519), Black Base with Granite Gray Top & Doors (426).

6" Casters: 2 fixed, 2 swivel with brake.

Top work area dimensions: 22¹/₂" x 26"



Shown with optional cutting board and paper towel roll dispenser.



CODE	DESCRIPTION	DIMENSIONS L x W x H	LIST PRICE EA.
KWS40	Work station	40 ³ / ₁₆ " x 33" x 45 ¹ / ₂ "	\$ 2,670.00
CB1220	Cutting board	21" x 13 ³ / ₈ " x 1 ¹ / ₂ "	42.00

Case Pack: 1

Equipment Stand

- Perfect for self-serve stations, prep areas or cash register service.
- Counter and side openings for electrical cords and cables.
- Tray rails fold down for convenient transportation and storage.
- Durable, lightweight polyethylene will not crack, dent, bubble, chip, rust or break.
- No assembly required.

Color: Black (110).

5" Casters: 2 fixed, 2 swivel with brake.

*Special order item not carried in stock, non-returnable.







Cutaway chair area gives ample space for comfortable seating.

CODE	DESCRIPTION	OVERALL DIMENSIONS W (W/TRAY RAILS) x D x H	LIST PRICE EA.
ES28	Stand only	28" x 28" x 39"	\$ 1,355.00
ES28RL*	Stand w/rails on right and left sides of drawer	44" x 28" x 39"	1,805.00

Height includes casters.

CAMCRUISER® VENDING CARTS

- Add revenue opportunities away from the kitchen or cafeteria and reduce wait times.
- Durable polyethylene will not crack, dent, bubble, chip, rust or break.
- Display panel can be personalized with a custom logo or message.
- Larger models CVC724 & CVC72 have insulated food storage compartments and full-size food pan wells.
- Compact model CVC55 has two open storage compartments, a single food pan well, cutting board and umbrella.

Cart Colors	Umbrella Colors
Black (110)	
Hot Red (158)	
Kentucky Green (519)	
Granite Gray (191)	
Granite Green (192)	



CVC724

OPEN COMPARTMENT DIMENSIONS:
W 13½" x D 24¼" x H 13½"
W 33,5 x D 61,5 x H 34 cm

CVC724 & CVC72



CVC724 has four full size food pan wells. Fill with cutting boards or well covers to create additional work space.



CVC72 Has one full size food pan well and two larger merchandising wells.



CVC72



Open holding compartment conveniently stores cash box and tray.



Place one or two half size Camchillers® directly on top of food pan well to hold cold packaged foods cold.

CODE	CVC724	CVC72	CVC55
OVERALL DIMENSION*	L 74½" x W 31¾" x H 94"	L 74½" x W 31¾" x H 94"	L 55⅞" x W 31¼" x H 93½"
WORK COUNTER HEIGHT	36½" (93 cm)	36½" (93 cm)	39¾" (101 cm)
COUNTER WELLS HOLD	4 full size pans, 6" deep	Center well, 1 full size pan, 6" deep 2 outer wells, L 22⅞" x W 15⅞" x D 6"	1 full size pan, 8" deep
CLOSED COMPARTMENT CAPACITY (EACH)	2 full size 8" + 2 full size 2½" deep pans or 4 full size 6" deep pans or 6 full size 4" deep pans or 8 full size 2½" deep pans or 4 each 2025 Camtrays or 8 each 3253 Camtrays	2 full size 8" + 2 full size 2½" deep pans or 4 full size 6" deep pans or 6 full size 4" deep pans or 8 full size 2½" deep pans or 4 each 2025 Camtrays or 8 each 3253 Camtrays	—
OPEN COMPARTMENT CAPACITY	1 cash drawer and 1 full size 6" deep pan or 2 full size 4" deep pans or 3 full size 2½" deep pans	1 cash drawer and 1 full size 6" deep pan or 2 full size 4" deep pans or 3 full size 2½" deep pans	—
UMBRELLA DIAMETER	72" (183 cm)	72" (183 cm)	60" (152 cm)
CASTERS	8" – 4 swivel with brake	8" – 4 swivel with brake	6" – 2 fixed, 2 swivel with brake
CASH DRAWER	Yes	Yes	—
MENU BOARD	Yes	Yes	—
DISPLAY PANEL	Yes	Yes	Yes
MOLDED IN HANDLES	2	2	1
LIST PRICE EACH	\$ 6,280.00	\$ 6,280.00	\$ 3,760.00

*Includes Umbrella. Serving counter height is 51".

CAMCRUISER® VENDING CARTS



CVC55



LEFT COMPARTMENT DIMENSIONS:
W 24½" x D 28½" x H 27½"

RIGHT COMPARTMENT DIMENSIONS:
W 21½" x D 28½" x H 27½"

- Compartments are open for storage and easy access to equipment and supplies for your vending operations. Optional retainer strap is sold separately.
- Display panel can be personalized.



Personalize your Camcruiser Cart to promote your brand.

Front Display Panel
"Campus Cuisine" display panel standard on CVC724 & CVC72. Striped panel standard on CVC55.

Set Up Charge per Panel \$ 135.00 (Net)
Charge per Color 10.00 (Net)



Sandwich Camcruiser

Pizza Camcruiser



Hot Dog Camcruiser

Soft Drink Camcruiser

Cutting Board Color: White (148).
Camchiller® Color: Cold Blue (159).
Divider Bar Colors: White (148), Clear (135).
Retainer Strap Color: Black (110).
ThermoBarrier® Color: Dark Brown (131).

ThermoBarrier, Camchillers and Divider Bar are NSF Listed.

Well Cover Color matches cart.

CVC55 is covered by U.S. Patent D 362,102.



CVC55



Set up with full or fractional size food pans and divider bars to increase product offerings.



Electrical or soda line conveniently drops through 4" x 6¼" opening in counter. Cover is standard with cart.

CODE	DESCRIPTION	FITS	OVERALL DIM. L x W x H	LIST PRICE EA.
Optional Accessories				
CB1220	Cutting board	CVC724, CVC72, CVC55	21" x 13⅝" x ½"	\$ 42.00
1200DIV	ThermoBarrier	CVC724, CVC72	20⅞" x 13⅝" x 1⅝"	89.00
CP1220	1/1 GN Camchiller	CVC724, CVC72	20⅜" x 12⅞" x 1½"	140.00
CP1210	1/2 GN Camchiller	CVC724, CVC72	10⅜" x 12¾" x 1½"	73.00
CP814	Camchiller	CVC72, CVC724	14" x 8" x 1½"	73.00
DIV12	Divider bar	CVC724, CVC72, CVC55	Well only	4.20
WCR1220	Well cover	CVC724, CVC72, CVC55	21" x 13" x 2"	105.00
730STP	Retainer strap	CVC55	—	26.00

DIV12 Case Pack: 3 1200DIV Case Pack: 2 730STP Retainer Strap Case Pack: 2 All Others Case Pack: 1

CAMSHELVING® PREMIUM SERIES AND ELEMENTS SERIES FLEX STATION

- Reduce serving time by setting up portable Grab-N-Go stations in convenient locations.
- Ideal for breakfast to go, fresh fruit and vegetable programs, boosting a la carte sales and supper or summer feeding programs.
- Order food pans, boxes and lids separately to hold and display items for quick access.
- Freeze Compact Camchiller® overnight. Place inside full size food pans or food boxes to keep fruits, vegetables and beverages cool and delicious for hours.



Camshelving Elements



Camshelving Premium



Angled Divider Bars

Securely hold food pans and boxes in place allowing easy access.



Camwear Food Storage Box

Shatterproof and durable, clear box allows for content visibility. Ideal for serving bulk fruits and vegetables during the day and keeping them fresh in a cooler or freezer overnight.



Camwear Food Pans

Store, transport, and serve all in one pan. Durable black food pans provide a sleek, modern look and are easy to clean and store when not in use.

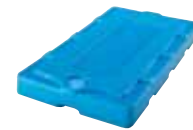

Compact Camchiller

Keep temperature sensitive items cool for hours with Camchillers. Reduce the risk of cross contamination by eliminating the use of ice.

Flex Station

CODE	DESCRIPTION	DIMENSIONS D x L x H	LIST PRICE EA.
CPMU244867FXPKG	Premium Series Flex Station	24" x 48" x 67"	\$1068.90
EMU244870FXPKG	Elements Series Flex Station	24" x 48" x 70"	932.20

Units Include: 2 unassembled mobile post kits, 8 traverses, 36 angled divider bars (4 extra) 4 total locking casters and 24 identification tags. Assembly required. Ships in 17 cartons. Height includes casters.

Accessories – Combine and Create Custom Flex Station

CODE	DESCRIPTION	DIMENSIONS D x L x H	CASE PACK	LIST PRICE EA.
16CW	Full Size Camwear® Food Pan	12¾" x 20⅞" x 6"	6	\$32.95
24LPCW	Half Size Long Camwear Food Pan	6⅜" x 20⅞" x 4"	6	20.20
12189CW	Half Size Camwear Food Box	12" x 18" x 9"	6	41.00
1218SCCW	Camwear SlidingLid™ for Food Box	12" x 18"	6	31.80
CP814	Compact Camchiller	8" x 14" x 1½"	1	70.00

16CW and 24LPCW Food Pans Colors: Black (110), Clear (135).
12189CW Food Box and 1218SCCW Sliding Lid Color: Clear (135).
CP814 Color: Cold Blue (159).

BOOSTER SEATS & VERSA ORGANIZERS

Booster Seats

- Contoured seat, high sides, wide square base and non-skid surface for toddler comfort and safety.
- Choose from dual or single seat models, with or without strap.
- Durable polyethylene will not crack, dent, bubble, chip, rust or break.

Colors: Black (110), Dark Brown (131), Coffee Beige (157), Navy Blue (186), Kentucky Green (519), Hot Red (158).

No broken cartons on 4 pack.



Booster seats are available with or without straps.

DIMENSIONS	W x D x H
Overall	11 ⁵ / ₈ " x 11 ¹ / ₄ " x 8 ⁵ / ₈ "
Seat Base	8 ³ / ₄ " x 9 ³ / ₄ "
Inside Seat	9 ¹ / ₂ " x 9 ³ / ₄ " x 4 ³ / ₈ "

DIMENSIONS	W x D x H
Overall	12 ⁷ / ₁₆ " x 12 ¹ / ₄ " x 9 ⁵ / ₈ "
Seat Base A	12 ⁷ / ₁₆ " x 12 ¹ / ₄ "
Seat Base B	12 ⁵ / ₈ " x 12 ⁵ / ₈ "
Inside Seat A	8 ¹ / ₄ " x 9 ⁵ / ₈ " x 3 ¹ / ₄ "
Inside Seat B	10 ³ / ₄ " x 10 ³ / ₄ " x 4 ³ / ₄ "

CODE	100BC	100BC1	100BCS
Single Seat			
DESCRIPTION	no strap	no strap	with strap
CASE PACK	4	1	4
LIST PRICE EACH	\$ 44 .00	\$ 49.00	\$ 65.00

CODE	200BC	200BC1	200BCS
Dual Seat			
DESCRIPTION	no strap	no strap	with strap
CASE PACK	4	1	4
LIST PRICE EACH	\$ 60.00	\$ 65.00	\$ 75 .00

Versa Organizers

- Use to store non-perishable condiments, disposable ware and napkins.
- Hold bins in 2 x 3, 2 x 4, 3 x 3, or 3 x 4 arrangements.
- Made of seamless, one-piece polyethylene.
- Set on flat surface or wall mount each bin holds up to 10 lbs. (4,5 kg).
- Easy to assemble and easy to clean.

Bins Only

Colors: Dark Brown (131), Black (110), Slate Blue (401), Speckled Gray (480).

Versa Line Combined Pack Bins & Racks

Colors: Black (110), Speckled Gray (480).



12RS12 Versa Organizer shown mounted on wall.



Bins sold separately (5412CBP) or as combined packs.



8RS8



6RS6

CODE	DESCRIPTION	PRODUCT DIMENSIONS	CASE PACK	LIST PRICE EA.
Bins				
W x D x H				
5412CBP		5" x 12" x 4 ¹ / ₄ "	12	\$ 9.95
Versa Line Combined Pack				
L x D x H (complete unit)				
12RS12	Rack w/12 bins	25 ⁵ / ₈ " x 21 ³ / ₈ " x 14 ¹ / ₄ "	1	203.00
9RS9	Rack w/9 bins	20 ⁵ / ₈ " x 21 ³ / ₈ " x 14 ¹ / ₄ "	1	179.00
8RS8	Rack w/8 bins	25 ⁵ / ₈ " x 17 ³ / ₄ " x 9 ³ / ₄ "	1	164.00
6RS6	Rack w/6 bins	20 ⁵ / ₈ " x 17 ³ / ₄ " x 9 ³ / ₄ "	1	147.00



PORTABLE CAMBARS®

- Stylish, portable beverage bars for hosting in any environment.
- Select from three systems: economy for bottle and can service, partial or complete soda gun set up systems for pre-mix (canisters) or post-mix (bag-in-box).
- Available in three sizes:
 - Large BAR730 is perfect for banquets and cocktail events.
 - Mid-size BAR650 fits into standard elevators and is ideal for small to mid-size functions.
 - Small BAR540 is ultra portable for off-premise use and events with limited space.
- All models include speed rail and 80-pound capacity ice sink with cover. BAR540 sink comes uncovered.
- Impact-resistant, waterproof polyethylene will not crack, dent, bubble, chip, rust or break.
- Lightweight and portable.
- Easy to take apart and clean, easy to set up.





BAR650 Shown in Standard Decor Granite Sand (194).



BAR650DS Shown in Designer Decor Sedona (668).

Three Sizes

Three Systems

	Economy System	Basic System	Complete System
<p>Large BAR730 Models</p> 	<ul style="list-style-type: none"> • For Bottle, Can, or Mixer Service • Includes Ice Bin & Speed Rail • Standard or Designer Decor 	<ul style="list-style-type: none"> • Partially Equipped for Post or Pre-Mix Soda Service • Operator Completes Installation • Standard or Designer Decor 	<ul style="list-style-type: none"> • Completely Factory Equipped for Post or Pre-Mix Soda Service • Standard or Designer Decor
<p>Standard Decor BAR730</p> <p>Designer Decor BAR730DS</p>	<p>Standard Decor BAR730CP</p> <p>Designer Decor BAR730DSCP</p>	<p>Standard Decor BAR730PM, BAR730PMT, BAR730PMT220, BAR730DX</p> <p>Designer Decor BAR730DSPM, BAR730DSPMT, BAR730DSPMT2, BAR730DSDX</p>	
<p>Mid-Size BAR650 Models</p> 	<p>Standard Decor BAR650</p> <p>Designer Decor BAR650DS</p>	<p>Standard Decor BAR650CP</p> <p>Designer Decor BAR650DSCP</p>	<p>Standard Decor BAR650PM, BAR650PMT, BAR650PMT220, BAR650DX</p> <p>Designer Decor BAR650DSPM, BAR650DSPMT, BAR650DSPMT2, BAR650DSDX</p>
<p>Small BAR540 Models</p> 	<p>Standard Decor BAR540</p> <p>Designer Decor BAR540DS</p>	N/A	N/A

PORTABLE CAMBAR® PACKAGES & ACCESSORIES

STANDARD EQUIPMENT, SODA GUNS, STANDARD AND DESIGNER DECOR PACKAGES

STANDARD DECOR EQUIPMENT DESIGNER DECOR EQUIPMENT	ECONOMY			BASIC SYSTEM		COMPLETE SYSTEM POST-MIX (Bag in Box)				COMPLETE SYSTEM PRE-MIX (Canisters)	
	BAR540 BAR540DS	BAR650 BAR650DS	BAR730 BAR730DS	BAR650CP BAR650DSCP	BAR730CP BAR730DSCP	BAR650PM BAR650DSPM	BAR650PMT BAR650DSPMT	BAR730PM BAR730DSPM	BAR730PMT BAR730DSPMT	BAR650DX BAR650SDX	BAR730DX BAR730SDX
Bag In Box Syrup Pumps						3	3	6	6		
Bag In Box Rack (Holds 3 Boxes)						1	1	2	2		
Carbonator						YES	YES	YES	YES		
CO ₂ Regulator						YES	YES	YES	YES	YES	YES
CO ₂ Clamp & Chain				YES	YES	YES	YES	YES	YES	YES	YES
8 Circuit Cold Plate in Ice Sink				YES	YES	YES	YES	YES	YES	YES	YES
Ice Sink and Cover	Sink Only	YES	YES	YES	YES	YES	YES	YES	YES	YES	YES
Retainer Strap		1	2	1	2	1	1	2	2	1	2
Soda Gun (5, 6 or 8 buttons)						5	5	8	8	5	6
Speed Rail (5 or 7 bottle)	5	7	7	7	7	7	7	7	7	7	7
Water Pump						YES	YES	YES	YES		
Water Tank							YES		YES		
Water Line Hook Up (city source)						YES	YES	YES	YES		
Waste Water Bin		YES	YES	YES	YES	YES	YES	YES	YES	YES	YES
Vinyl Cover	YES	YES	YES	YES	YES	YES	YES	YES	YES	YES	YES

Casters: All BAR540 Models - Four 5" (12,7 cm) swivel, two with brake. All BAR650 and BAR730 Models - Four 6" (15,24 cm) swivel, two with brake.

Soda Guns by Wunder-Bar®

- Fast, low foaming delivery.
- Two year warranty from Wunder-Bar®.
- Includes holster with overflow drain.
- Available with complete systems only.



Post-Mix 8 Button
(BAR730 Complete System)



Post-Mix 5 Button
(BAR650 Complete System)



Pre-Mix 6 Button
(BAR730 Complete System)



Pre-Mix 5 Button
(BAR650 Complete System)

Standard Decor Colors BAR540, BAR650, BAR730



110
Black



191
Granite Gray



194
Granite Sand

BAR650, BAR730 Only

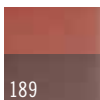

189
Two-Tone Brown
Mahogany



420
Granite Gray w/
Black Base

BAR540 Only



131
Dark Brown

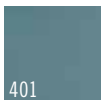

401
Slate Blue

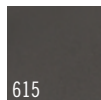

615
Charcoal Gray

Designer Decor BAR650, BAR730 Only



667
Manhattan

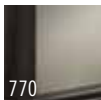

770
Chicago



668
Sedona



669
Carmel

BAR540 Designer Decor color options are listed with BAR540 details.

Exclusive Cold Plate

- Patented "roof top" design allows for melted ice water to drain into the bottom of the ice sink and into the waste-water bin.
- Circuit exposure through cold plate chills liquids dispensed from the soda gun.



Cold Plate is covered under
U.S. Patent 5,743,602.

Optional Accessories for CamBars

CODE	DESCRIPTION	LIST PRICE EA.
650WS	Wire shelf for BAR650	\$ 66.00
730WS	Wire shelf for BAR730	46.00
730SR	7 bottle speed rail	105.00
BAR54SR	5 bottle speed rail	72.00

Case Pack: 1

730SR Speed Rail Colors: Black (110), Dark Brown (131), Granite Gray (191).

BAR54SR Speed Rail Colors: Black (110), Dark Brown (131), Gray (180), Granite Gray (191), Granite Sand (194), Slate Blue (401).

CAMBAR® POST-MIX SYSTEM FEATURES

Redesigned for Peak Functionality

- Soda gun and GFI-protected 110V outlet are ergonomically positioned for convenient operator access and maximized workspace.
- NSF listed beverage line with Flushable Glas-Flex™ liner for easy flushing and changing of even the strongest flavors.
- Hygienic and easy-to-clean.

Front

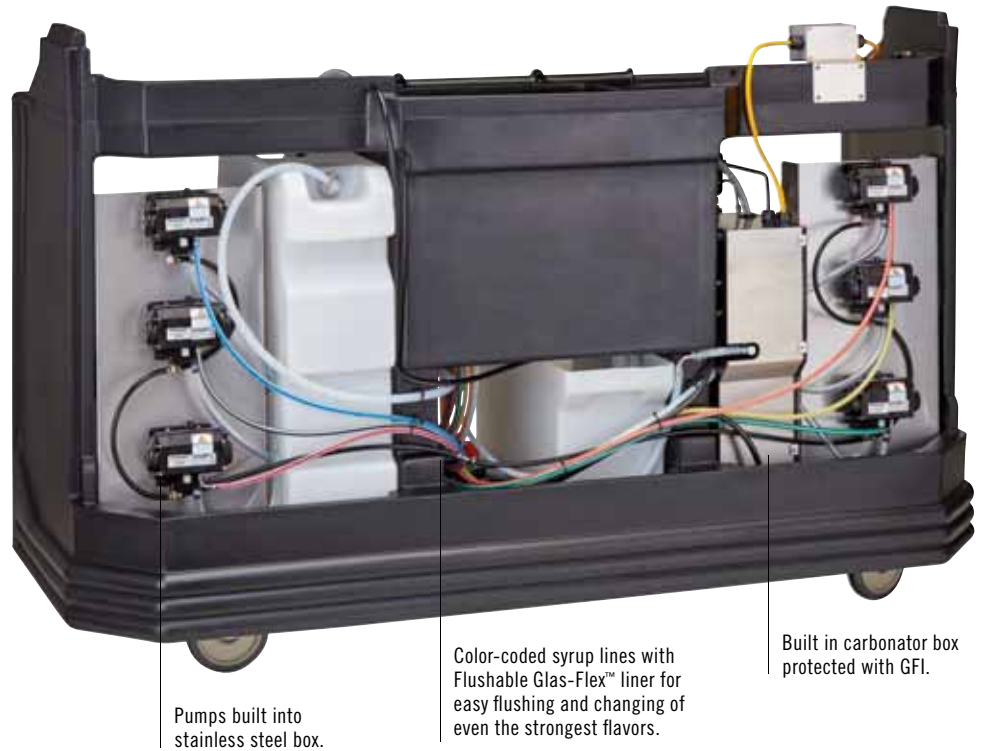

Back

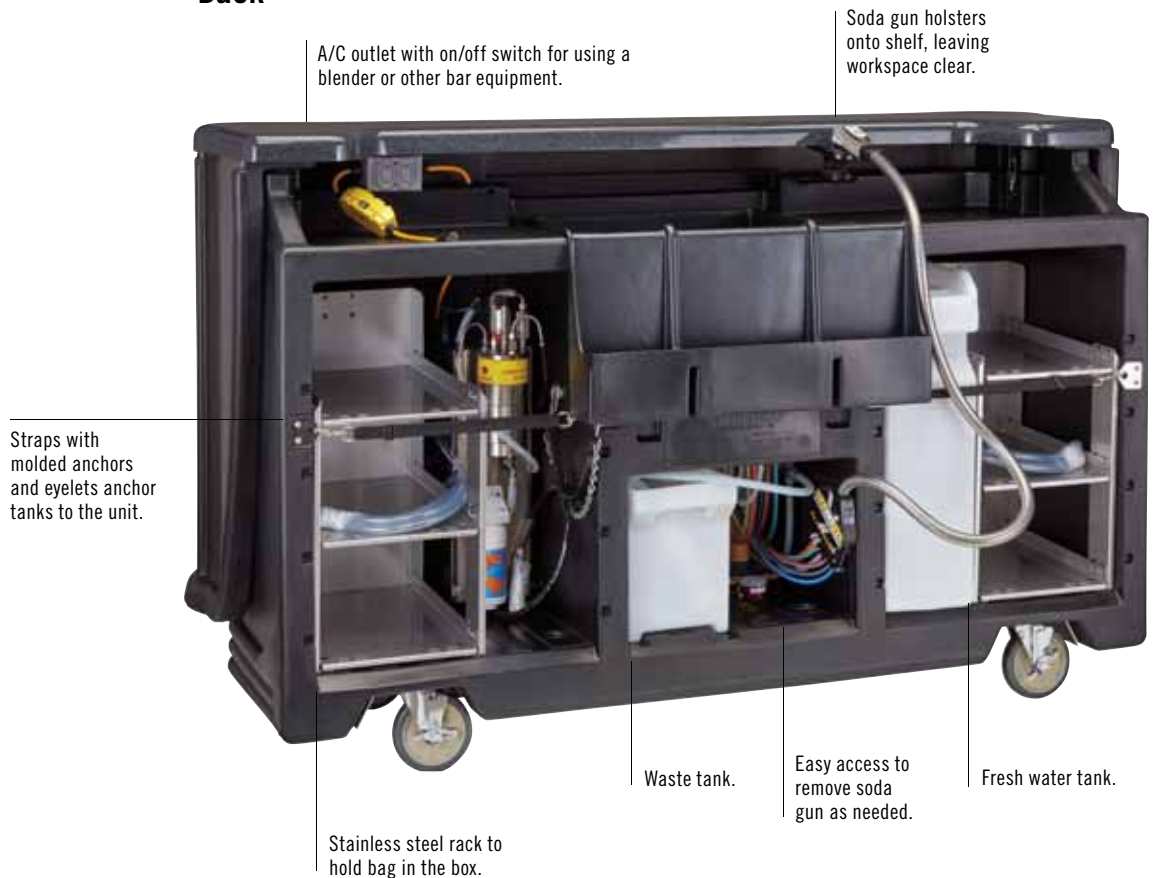

LARGE CAMBARS® – COMPLETE SYSTEMS BAR730

Post-mix System for 5-gallon (18,9 L), Bag-in-box Syrups Holds up to 6 syrup boxes and 1 CO₂ tank.

BAR730PM and BAR730DSPM

Includes the standard equipment from the Basic System plus:

- Post-mix soda gun with 8 buttons
- Carbonator
- 2 stainless steel bag-in-box wire racks
- 6 bag-in-box pumps
- CO₂ regulator gauge & tubing, hose & lines
- Line for city water hook-up

BAR730PMT, BAR730DSPMT, BAR730PMT220 and BAR730DSPMT2

Includes all of the above plus 1, 17-gallon (64,3 L) water tank and 1 water pump. Line for city water hook-up is not included.



BAR730SDSX Shown in Designer Decor Carmel (669).



Cold Plate



BAR730DSPMT Shown with water tank and bag-in-box racks.



CODE	VOLTS	WATER TANK	DIMENSIONS L x W x H	UNIT WEIGHT	LIST PRICE EA.
Standard Decor					
BAR730PM	110	No	72¾" x 26" x 48"	335 lbs.	\$ 14,920.00
BAR730PMT	110	Yes	72¾" x 26" x 48"	346	16,310.00
BAR730PMT220	220	Yes	72¾" x 26" x 48"	346	16,430.00
Designer Decor					
BAR730DSPM	110	No	77⅞" x 28½" x 47½"	388	16,840.00
BAR730DSPMT	110	Yes	77⅞" x 28½" x 47½"	398	18,960.00
BAR730DSPMT2	220	Yes	77⅞" x 28½" x 47½"	398	19,080.00



Vinyl cover included with all CamBars. Cover not NSF listed.

Pre-mix System for 5-gallon (18,9 L) Soda Canisters Holds up to 7 canisters and 1 CO₂ tank.

BAR730DX and BAR730SDSX

Includes the standard equipment from the Basic System plus:

- Pre-mix soda gun with 6 buttons

CODE	WATER TANK	DIMENSIONS L x W x H	UNIT WEIGHT	LIST PRICE EA.
Standard Decor				
BAR730DX	No	72¾" x 26" x 48"	293 lbs.	\$ 9,950.00
Designer Decor				
BAR730SDSX	Yes	77⅞" x 28½" x 47½"	332	13,305.00



Cold Plate



BAR730DX

LARGE CAMBARS® – ECONOMY AND BASIC SYSTEMS BAR730

Basic System BAR730 Partially Equipped for Soda Service

Requires customer installation of pre-mix or post-mix soda gun system.

Includes:

- Sealed-in cold plate w/8 circuits
- CO₂ chain
- 7-bottle speed rail
- 80-pound (36,3 kg) capacity ice sink
- Ice sink cover
- Waste-water bin
- 2 retainer straps
- 4, 6" (15,2 cm) swivel casters, 2 with brake
- Vinyl cover

CODE	DIMENSIONS L x W x H	UNIT WEIGHT	LIST PRICE EA.
Standard Decor			
BAR730CP	72¾" x 26" x 48"	291 lbs.	\$ 8,595.00
Designer Decor			
BAR730DSCP	77⅞" x 28½" x 47½"	321	12,130.00



Cold Plate

BAR730DSCP
Shown with four optional wire racks; see details under Portable CamBar Packages & Accessories.

Economy System BAR730 For Bottle, Can or Mixer Service

Includes:

- 7-bottle speed rail
- 80-pound (36,3 kg) capacity ice sink
- Ice sink cover
- Waste-water bin
- 2 retainer straps
- 4, 6" (15,2 cm) swivel casters, 2 with brake
- Vinyl cover

CODE	DIMENSIONS L x W x H	UNIT WEIGHT	LIST PRICE EA.
Standard Decor			
BAR730	72¾" x 26" x 48"	198 lbs.	\$ 6,020.00
Designer Decor			
BAR730DS	77⅞" x 28½" x 47½"	245	8,095.00



MID-SIZE CAMBARS® – COMPLETE SYSTEMS BAR650

**Post-mix System for
5-gallon (18,9 L) Bag-in-box Syrups
Holds up to 3 syrup boxes and 1 CO₂ tank.**

BAR650PM and BAR650DSPM

Includes the standard equipment from the Basic System plus:

- Post-mix soda gun with 5 buttons
- Carbonator
- Stainless steel bag-in-box wire rack
- 3 bag-in-box pumps
- CO₂ regulator gauge & tubing, hose & lines
- Line for city water hook-up
- Water pump
- Water filter

BAR650PMT, BAR650DSPMT, BAR650PMT220 and BAR650DSPMT2

Includes all of the above plus 1, 17-gallon (64,3 L) water tank and 1 water pump. Line for city water hook-up is not included.

CODE	VOLTS	WATER TANK	DIMENSIONS L x W x H	UNIT WEIGHT	LIST PRICE EA.
Standard Decor					
BAR650PM	110	No	67½" x 28½" x 47½"	301 lbs.	\$ 13,875.00
BAR650PMT	110	Yes	67½" x 28½" x 47½"	312	15,205.00
BAR650PMT220	220	Yes	67½" x 28½" x 47½"	312	15,660.00
Designer Decor					
BAR650DSPM	110	No	67½" x 28½" x 47½"	348	15,305.00
BAR650DSPMT	110	Yes	67½" x 28½" x 47½"	359	17,250.00
BAR650DSPMT2	220	Yes	67½" x 28½" x 47½"	359	17,365.00



Cold Plate



BAR650DSPMT
Shown with water tank and bag-in-box rack.

**Pre-mix System for 5-gallon (18,9 L) Soda Canisters
Holds up to 5 canisters and 1 CO₂ tank.**

BAR650DX and BAR650SDSX

Includes the standard equipment from the Basic System plus:

- Pre-mix soda gun with 5 buttons

CODE	DIMENSIONS L x W x H	UNIT WEIGHT	LIST PRICE EA.
Standard Decor			
BAR650DX	67½" x 28½" x 47½"	265 lbs.	\$ 9,305.00
Designer Decor			
BAR650SDSX	67½" x 28½" x 47½"	312	11,240.00



Cold Plate



BAR650SDSX

MID SIZE AND SMALL CAMBARS® – ECONOMY AND BASIC SYSTEMS

Basic System BAR650 – Mid-Size Model Partially Equipped for Soda Service

Requires customer installation of pre-mix or post-mix soda gun system.

- Includes:**
- Sealed-in cold plate with 8 circuits
 - CO₂ chain
 - 7-bottle speed rail
 - 80-pound (36,3 kg) capacity ice sink
 - Ice sink cover
 - Waste-water bin
 - Retainer strap
 - 4, 6" (15,2 cm) swivel casters, 2 with brake
 - Vinyl cover

CODE	DIMENSIONS L x W x H	UNIT WEIGHT	LIST PRICE EA.
Standard Decor			
BAR650CP	67½" x 28½" x 47½"	285 lbs.	\$ 7,570.00
Designer Decor			
BAR650DSCP	67½" x 28½" x 47½"	303	9,770.00



Cold Plate

BAR650DSCP
Shown with two optional wire racks; see details under Portable CamBar Packages & Accessories.

Economy System BAR650 – Mid-Size Model For Bottle, Can or Mixer Service

- Includes:**
- 7-bottle speed rail
 - 80-pound (36,3 kg) capacity ice sink
 - Ice sink cover
 - Waste-water bin
 - Retainer strap
 - 4, 6" (15,2 cm) swivel casters, 2 with brake
 - Vinyl cover

CODE	DIMENSIONS L x W x H	UNIT WEIGHT	LIST PRICE EA.
Standard Decor			
BAR650	67½" x 28½" x 47½"	173 lbs.	\$ 5,140.00
Designer Decor			
BAR650DS	67½" x 28½" x 47½"	220	6,935.00



BAR650DS
Shown with two optional wire racks; see details under Portable CamBar Packages & Accessories.

Economy System BAR540 – Small Model For Bottle, Can, or Mixer Service

- Includes:**
- 5-bottle speed rail
 - 80-pound (36,3 kg) capacity ice sink
 - 4, 5" (12,7 cm) swivel casters, 2 with brake
 - Vinyl cover

CODE	DIMENSIONS L x W x H	UNIT WEIGHT	LIST PRICE EA.
Standard Decor			
BAR540	54" x 25½" x 46½"	117 lbs.	\$ 2,635.00
Designer Decor			
BAR540DS	54" x 25½" x 46½"	123	3,345.00



BAR540DS

Designer Decor Colors

BAR540 Only

670 Black Base w/ Coal Counter

671 Granite Gray Base w/ Slate Gray Counter

672 Granite Sand Base w/ Cocoa Counter

SLIDINGLID™ ICE CADDIES



- Polyethylene body and thick foam insulation hold ice for days.
- Rugged, all-weather exterior will not crack, dent, bubble, chip, rust or break.
- Unique sliding lid slides back and under during use, reducing risk of cross-contamination.
- Recessed well and drain shelf keep ice out of water, extending holding times.
- Recessed, molded-in handles ease lifting and maneuvering.
- Slant top sliding lid units fit under prep/catering tables and counters.



ICS175LB
(Short) Shown with Rear Easy Wheels.



ICS125L
(Short)



ICS100L4S
(Short)

ICS100L
(Short)



ICS175T
(Tall)



BAR650DS shown in Designer Decor Sedona (668) with ICS175TB shown in Granite Gray (191).



ICS175TB
(Tall) Shown with Rear Easy Wheels.



ICS200TB
(Tall) Shown with Rear Wide Easy Wheels.

Colors: Black (110), Slate Blue (401), Dark Brown (131), Coffee Beige (157), Granite Gray (191).

Personalization available. Special quote only. Contact customer service.

SlidingLid Ice Caddies ICS125L and ICS125LB are covered by US Patent D 468,071 S. SlidingLid Ice Caddies ICS100L and ICS100L4S are covered by US Patent D 424,883.



Caster Descriptions

Refers to caster type in chart.
All casters are 5" (12,7 cm).

A: 2 fixed, 2 swivel, 1 with brake

A1: 2 swivel, 2 with brakes

B: 4 swivel, 1 with brake

C: 2 swivel, 1 with brake, 2, 8" Easy Wheels

D: 2 swivel, 1 with brake, 2, 10" Easy Wheels

E: 2 swivel, 1 with brake, 2, 10" Wide Easy Wheels



CODE	HOLDING CAPACITY LBS.	EXTERIOR DIMENSIONS W x D x H	CASTER TYPE	LIST PRICE EA.
Short				
ICS100L	100	22½" x 30¾" x 28¾"	A1	\$ 1,040.00
ICS100L4S	100	22½" x 30¾" x 28¾"	B	1,070.00
ICS125L	125	23" x 31½" x 29¼"	A	1,065.00
ICS125LB	125	23" x 31½" x 29¼"	C	1,140.00
ICS175L	175	24" x 37½" x 29¼"	A	1,265.00
ICS175LB	175	24" x 37½" x 29¼"	D	1,320.00
Tall				
ICS125T	125	23" x 31½" x 34½"	A	1,130.00
ICS175T	175	23" x 34" x 37½"	A	1,330.00
ICS175TB	175	23" x 34" x 37½"	D	1,415.00
ICS200TB	200	23" x 34" x 39½"	E	1,450.00

Case Pack: 1 **InStock Colors:** Black (110), Dark Brown (131).



WAREWASHING AND STORAGE SYSTEM

Camrack® 4-in-1 Warewashing System

Camdollies®

Utility Trucks

Tray & Dish Cart / Tray & Silverware Cart

S-Series Adjustable Dish Caddy

Dish Caddies, Adjustable Tray & Dish Cart

Cambox® Bus Boxes

KD Service Cart and KD Utility Cart

Service Carts



CAMRACK® 4-IN-1 WAREWASHING SYSTEM

The Camrack System will protect glassware and keep it clean until the next event, eliminating the need for rewashing.

Camrack Cover Seals from the Top and Camdolly® Seals from the Bottom

Efficient Washing

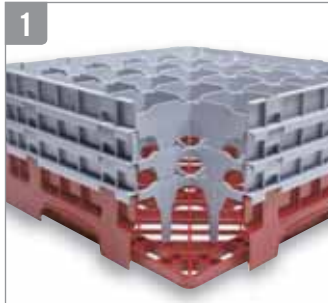

Open inside compartments provide thorough circulation of water and cleaning solutions and promote quick and thorough drying.

Long-lasting polypropylene Camracks are built to withstand chemicals and high temperatures up to 200°F (93°C).

Sanitary Storage



Closed outer walls keep fingers and contaminants out and reduce risk of breakage and injury. The Camrack cover and Camdolly make this system completely enclosed. Glassware stays clean when in storage, so operators will only have to wash items once.

Inventory Control



A variety in base rack colors help identify at a glance both contents and quantity per rack. Available in 10 colors.

Safe, Sanitary Transportation



Camracks can be transported across large campuses or to off-site locations in one single unit.

Easy to grip handles and smooth overlapping sides facilitate safe handling.



Camracks interstack with racks from major manufacturers.



Content labeling options include one-color custom hot stamping or pre-printed clips.



Camracks are covered by one or more of the following patents: Full Base Dish Rack D 412,607. Half Base Dish Rack D 404,176. Half Dish Rack Extender D 400,321. Enlarged Dish Rack Extender D 399,614. Dish Rack with Extender 5,934,486 Utility Patent. Pronged Base Dish Rack D 403,472.

FULL SIZE CAMRACKS® FOR STEMWARE & TUMBLERS

These racks offer complete protection for all your delicate and valuable stemware and tumblers, from washing and handling to stacking, storing and transporting.

Choose the correct dishrack:

1. Measure the maximum diameter of your glass (stemware or tumbler) to determine the number of compartments.
2. Measure the maximum height of your glass (stemware or tumbler) to the top edge of the rim to determine the compartment height.

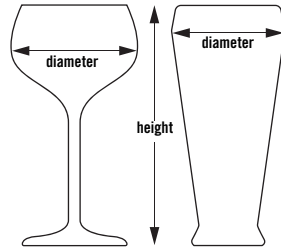

25S534

Camrack Sizing Guides are available at www.cambro.com/mycamracks and on the Cambro App.

9 COMPARTMENT

5 7/8" 5.875" (14,9 cm)
MAXIMUM DIAMETER



MAXIMUM HEIGHT	3 5/8" 3.625" (9,2 cm)	5 1/4" 5.25" (13,3 cm)	6 7/8" 6.875" (17,4 cm)	8 1/2" 8.5" (21,5 cm)	10 1/8" 10.125" (25,7 cm)	11 3/4" 11.75" (29,8 cm)
CODE	9S318	9S434	9S638	9S800	9S958	9S1114
CASE PACK	5	4	3	2	2	2
RACK DIMENSION	19 3/4" x 19 3/4" x 5 5/8" 50 x 50 x 14,3 cm	19 3/4" x 19 3/4" x 7 1/4" 50 x 50 x 18,4 cm	19 3/4" x 19 3/4" x 8 3/8" 50 x 50 x 22,5 cm	19 3/4" x 19 3/4" x 10 1/2" 50 x 50 x 26,7 cm	19 3/4" x 19 3/4" x 12 5/8" 50 x 50 x 30,8 cm	19 3/4" x 19 3/4" x 13 3/4" 50 x 50 x 34,9 cm
LIST PRICE EACH	\$ 56.90	\$ 74.20	\$ 88.55	\$ 107.70	\$ 124.85	\$ 145.40

16 COMPARTMENT

4 3/8" 4.375" (11,11 cm)
MAXIMUM DIAMETER



MAXIMUM HEIGHT	3 5/8" 3.625" (9,2 cm)	4 1/2" 4.5" (11,4 cm)	5 1/4" 5.25" (13,3 cm)	6 1/8" 6.125" (15,5 cm)	6 7/8" 6.875" (17,4 cm)	7 3/4" 7.75" (19,6 cm)
CODE	16S318	16S418**	16S434	16S534**	16S638	16S738**
CASE PACK	5	5	4	4	3	3
RACK DIMENSION	19 3/4" x 19 3/4" x 5 5/8" 50 x 50 x 14,3 cm	19 3/4" x 19 3/4" x 5 5/8" 50 x 50 x 14,3 cm	19 3/4" x 19 3/4" x 7 1/4" 50 x 50 x 18,4 cm	19 3/4" x 19 3/4" x 7 1/4" 50 x 50 x 18,4 cm	19 3/4" x 19 3/4" x 8 3/8" 50 x 50 x 22,5 cm	19 3/4" x 19 3/4" x 8 3/8" 50 x 50 x 22,5 cm
LIST PRICE EACH	\$ 56.90	\$ 59.60	\$ 74.55	\$ 76.35	\$ 89.50	\$ 91.35
MAXIMUM HEIGHT	8 1/2" 8.5" (21,5 cm)	9 3/8" 9.375" (23,8 cm)	10 1/8" 10.125" (25,7 cm)	11" 11" (27,9 cm)	11 3/4" 11.75" (29,8 cm)	12 5/8" 12.625" (32 cm)
CODE	16S800	16S900**	16S958	16S1058**	16S1114	16S1214**
CASE PACK	2	2	2	2	2	2
RACK DIMENSION	19 3/4" x 19 3/4" x 10 1/2" 50 x 50 x 26,7 cm	19 3/4" x 19 3/4" x 10 1/2" 50 x 50 x 26,7 cm	19 3/4" x 19 3/4" x 12 5/8" 50 x 50 x 30,8 cm	19 3/4" x 19 3/4" x 12 5/8" 50 x 50 x 30,8 cm	19 3/4" x 19 3/4" x 13 3/4" 50 x 50 x 34,9 cm	19 3/4" x 19 3/4" x 13 3/4" 50 x 50 x 34,9 cm
LIST PRICE EACH	\$ 108.05	\$ 110.00	\$ 124.85	\$ 126.80	\$ 145.40	\$ 147.15

Base Rack Colors:



Extender Color: Soft Gray (151). **Compartment Extenders cannot be added. Personalization available. See Camrack personalization and color coding page. Contact Customer Service for all special orders.

FULL SIZE CAMRACKS® FOR STEMWARE & TUMBLERS

3⁷/₈" 3.875" (9,84 cm)
MAXIMUM DIAMETER



20 COMPARTMENT

MAXIMUM HEIGHT	3 ⁵ / ₈ " 3.625" (9,2 cm)	5 ¹ / ₄ " 5.25" (13,3 cm)	6 ⁷ / ₈ " 6.875" (17,4 cm)	8 ¹ / ₂ " 8.5" (21,5 cm)	10 ¹ / ₈ " 10.125" (25,7 cm)	11 ³ / ₄ " 11.75" (29,8 cm)
CODE	20S318	20S434	20S638	20S800	20S958	20S1114
CASE PACK	5	4	3	2	2	2
RACK DIMENSION	19 ³ / ₄ " x 19 ³ / ₄ " x 5 ⁵ / ₈ " 50 x 50 x 14,3 cm	19 ³ / ₄ " x 19 ³ / ₄ " x 7 ¹ / ₄ " 50 x 50 x 18,4 cm	19 ³ / ₄ " x 19 ³ / ₄ " x 8 ⁷ / ₈ " 50 x 50 x 22,5 cm	19 ³ / ₄ " x 19 ³ / ₄ " x 10 ¹ / ₂ " 50 x 50 x 26,7 cm	19 ³ / ₄ " x 19 ³ / ₄ " x 12 ¹ / ₈ " 50 x 50 x 30,8 cm	19 ³ / ₄ " x 19 ³ / ₄ " x 13 ³ / ₄ " 50 x 50 x 34,9 cm
LIST PRICE EACH	\$ 56.90	\$ 75.50	\$ 90.30	\$ 108.05	\$ 124.85	\$ 145.40

3⁷/₁₆" 3.44" (8,7 cm)
MAXIMUM DIAMETER



25 COMPARTMENT

MAXIMUM HEIGHT	3 ⁵ / ₈ " 3.625" (9,2 cm)	4 ¹ / ₂ " 4.5" (11,4 cm)	5 ¹ / ₄ " 5.25" (13,3 cm)	6 ¹ / ₈ " 6.125" (15,5 cm)	6 ⁷ / ₈ " 6.875" (17,4 cm)	7 ³ / ₄ " 7.75" (19,6 cm)
CODE	25S318	25S418**	25S434	25S534**	25S638	25S738**
CASE PACK	5	5	4	4	3	3
RACK DIMENSION	19 ³ / ₄ " x 19 ³ / ₄ " x 5 ⁵ / ₈ " 50 x 50 x 14,3 cm	19 ³ / ₄ " x 19 ³ / ₄ " x 5 ⁵ / ₈ " 50 x 50 x 14,3 cm	19 ³ / ₄ " x 19 ³ / ₄ " x 7 ¹ / ₄ " 50 x 50 x 18,4 cm	19 ³ / ₄ " x 19 ³ / ₄ " x 7 ¹ / ₄ " 50 x 50 x 18,4 cm	19 ³ / ₄ " x 19 ³ / ₄ " x 8 ⁷ / ₈ " 50 x 50 x 22,5 cm	19 ³ / ₄ " x 19 ³ / ₄ " x 8 ⁷ / ₈ " 50 x 50 x 22,5 cm
LIST PRICE EACH	\$ 56.90	\$ 61.55	\$ 75.50	\$ 79.20	\$ 90.30	\$ 97.70
MAXIMUM HEIGHT	8 ¹ / ₂ " 8.5" (21,5 cm)	9 ³ / ₈ " 9.375" (23,8 cm)	10 ¹ / ₈ " 10.125" (25,7 cm)	11" 27,9 cm	11 ³ / ₄ " 11.75" (29,8 cm)	12 ⁵ / ₈ " 12.625" (32 cm)
CODE	25S800	25S900**	25S958	25S1058**	25S1114	25S1214**
CASE PACK	2	2	2	2	2	2
RACK DIMENSION	19 ³ / ₄ " x 19 ³ / ₄ " x 10 ¹ / ₂ " 50 x 50 x 26,7 cm	19 ³ / ₄ " x 19 ³ / ₄ " x 10 ¹ / ₂ " 50 x 50 x 26,7 cm	19 ³ / ₄ " x 19 ³ / ₄ " x 12 ¹ / ₈ " 50 x 50 x 30,8 cm	19 ³ / ₄ " x 19 ³ / ₄ " x 12 ¹ / ₈ " 50 x 50 x 30,8 cm	19 ³ / ₄ " x 19 ³ / ₄ " x 13 ³ / ₄ " 50 x 50 x 34,9 cm	19 ³ / ₄ " x 19 ³ / ₄ " x 13 ³ / ₄ " 50 x 50 x 34,9 cm
LIST PRICE EACH	\$ 108.05	\$ 117.40	\$ 124.85	\$ 136.00	\$ 145.40	\$ 156.45

**Compartment Extenders cannot be added.

3¹/₈" 3.125" (7,94 cm)
MAXIMUM DIAMETER



30 COMPARTMENT

MAXIMUM HEIGHT	3 ⁵ / ₈ " 3.625" (9,2 cm)	5 ¹ / ₄ " 5.25" (13,3 cm)	6 ⁷ / ₈ " 6.875" (17,4 cm)	8 ¹ / ₂ " 8.5" (21,5 cm)	10 ¹ / ₈ " 10.125" (25,7 cm)	11 ³ / ₄ " 11.75" (29,8 cm)
CODE	30S318	30S434	30S638	30S800	30S958	30S1114
CASE PACK	5	4	3	2	2	2
RACK DIMENSION	19 ³ / ₄ " x 19 ³ / ₄ " x 5 ⁵ / ₈ " 50 x 50 x 14,3 cm	19 ³ / ₄ " x 19 ³ / ₄ " x 7 ¹ / ₄ " 50 x 50 x 18,4 cm	19 ³ / ₄ " x 19 ³ / ₄ " x 8 ⁷ / ₈ " 50 x 50 x 22,5 cm	19 ³ / ₄ " x 19 ³ / ₄ " x 10 ¹ / ₂ " 50 x 50 x 26,7 cm	19 ³ / ₄ " x 19 ³ / ₄ " x 12 ¹ / ₈ " 50 x 50 x 30,8 cm	19 ³ / ₄ " x 19 ³ / ₄ " x 13 ³ / ₄ " 50 x 50 x 34,9 cm
LIST PRICE EACH	\$ 59.60	\$ 76.35	\$ 92.10	\$ 110.00	\$ 128.60	\$ 145.40

FULL SIZE CAMRACKS® FOR STEMWARE & TUMBLERS

36 COMPARTMENT

2⁷/₈" 2.875" (7,3 cm)
MAXIMUM DIAMETER



MAXIMUM HEIGHT	3 ⁵ / ₈ " 3.625" (9,2 cm)	4 ¹ / ₂ " 4.5" (11,4 cm)	5 ¹ / ₄ " 5.25" (13,3 cm)	6 ¹ / ₈ " 6.125" (15,5 cm)	6 ⁷ / ₈ " 6.875" (17,4 cm)	7 ³ / ₄ " 7.75" (19,6 cm)
CODE	36S318	36S418**	36S434	36S534**	36S638	36S738**
CASE PACK	5	5	4	4	3	3
RACK DIMENSION	19 ³ / ₄ " x 19 ³ / ₄ " x 5 ⁵ / ₈ " 50 x 50 x 14,3 cm	19 ³ / ₄ " x 19 ³ / ₄ " x 5 ⁵ / ₈ " 50 x 50 x 14,3 cm	19 ³ / ₄ " x 19 ³ / ₄ " x 7 ¹ / ₄ " 50 x 50 x 18,4 cm	19 ³ / ₄ " x 19 ³ / ₄ " x 7 ¹ / ₄ " 50 x 50 x 18,4 cm	19 ³ / ₄ " x 19 ³ / ₄ " x 8 ⁷ / ₈ " 50 x 50 x 22,5 cm	19 ³ / ₄ " x 19 ³ / ₄ " x 8 ⁷ / ₈ " 50 x 50 x 22,5 cm
LIST PRICE EACH	\$ 59.60	\$ 64.25	\$ 76.35	\$ 82.90	\$ 92.10	\$ 102.40
MAXIMUM HEIGHT	8 ¹ / ₂ " 8.5" (21,5 cm)	9 ³ / ₈ " 9.375" (23,8 cm)	10 ¹ / ₈ " 10.125" (25,7 cm)	11" 27,9 cm	11 ³ / ₄ " 11.75" (29,8 cm)	12 ⁵ / ₈ " 12.625" (32 cm)
CODE	36S800	36S900**	36S958	36S1058**	36S1114	36S1214**
CASE PACK	2	2	2	2	2	2
RACK DIMENSION	19 ³ / ₄ " x 19 ³ / ₄ " x 10 ¹ / ₂ " 50 x 50 x 26,7 cm	19 ³ / ₄ " x 19 ³ / ₄ " x 10 ¹ / ₂ " 50 x 50 x 26,7 cm	19 ³ / ₄ " x 19 ³ / ₄ " x 12 ¹ / ₈ " 50 x 50 x 30,8 cm	19 ³ / ₄ " x 19 ³ / ₄ " x 12 ¹ / ₈ " 50 x 50 x 30,8 cm	19 ³ / ₄ " x 19 ³ / ₄ " x 13 ³ / ₄ " 50 x 50 x 34,9 cm	19 ³ / ₄ " x 19 ³ / ₄ " x 13 ³ / ₄ " 50 x 50 x 34,9 cm
LIST PRICE EACH	\$ 110.00	\$ 122.10	\$ 128.60	\$ 140.70	\$ 145.40	\$ 159.45

**Compartment Extenders cannot be added.

49 COMPARTMENT

2⁷/₁₆" 2.44 (6,2 cm)
MAXIMUM DIAMETER



MAXIMUM HEIGHT	3 ⁵ / ₈ " 3.625" (9,2 cm)	5 ¹ / ₄ " 5.25" (13,3 cm)	6 ⁷ / ₈ " 6.875" (17,4 cm)	8 ¹ / ₂ " 8.5" (21,5 cm)	10 ¹ / ₈ " 10.125" (25,7 cm)	11 ³ / ₄ " 11.75" (29,8 cm)
CODE	49S318	49S434	49S638	49S800	49S958	49S1114
CASE PACK	5	4	3	2	2	2
RACK DIMENSION	19 ³ / ₄ " x 19 ³ / ₄ " x 5 ⁵ / ₈ " 50 x 50 x 14,3 cm	19 ³ / ₄ " x 19 ³ / ₄ " x 7 ¹ / ₄ " 50 x 50 x 18,4 cm	19 ³ / ₄ " x 19 ³ / ₄ " x 8 ⁷ / ₈ " 50 x 50 x 22,5 cm	19 ³ / ₄ " x 19 ³ / ₄ " x 10 ¹ / ₂ " 50 x 50 x 26,7 cm	19 ³ / ₄ " x 19 ³ / ₄ " x 12 ¹ / ₈ " 50 x 50 x 30,8 cm	19 ³ / ₄ " x 19 ³ / ₄ " x 13 ³ / ₄ " 50 x 50 x 34,9 cm
LIST PRICE EACH	\$ 60.55	\$ 78.20	\$ 94.10	\$ 110.00	\$ 130.45	\$ 150.95



Base Rack Colors:

 110 Black	 119 Sherwood Green	 151 Soft Gray	 163 Red	 167 Brown	 168 Blue	 184 Beige	 186 Navy Blue	 414 Teal	 416 Cranberry
--	---	--	--	--	---	--	--	---	--

Extender Color: Soft Gray (151). **Compartment Extenders cannot be added.
Personalization available. See Camrack personalization and color coding page. Contact Customer Service for all special orders.



HALF SIZE CAMRACKS® FOR STEMWARE & TUMBLERS

- Very effective for carrying less weight and for storing drinkware in space-restricted locations.
- Ideal for small under-counter glasswashers.

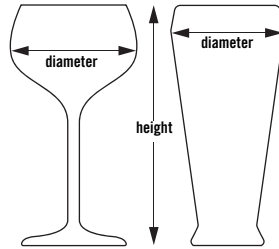

Camrack Sizing Guides are available at www.cambro.com under Reference Guides.

8 COMPARTMENT

4¹/₁₆" 4.06" (10,3 cm)
MAXIMUM DIAMETER



	3 ⁵ / ₈ " 3.625" (9,2 cm)	5 ¹ / ₄ " 5.25" (13,3 cm)	6 ⁷ / ₈ " 6.875" (17,4 cm)	8 ¹ / ₂ " 8.5" (21,5 cm)	10 ¹ / ₈ " 10.125" (25,7 cm)	11 ³ / ₄ " 11.75" (29,8 cm)
MAXIMUM HEIGHT						
CODE	8HS318	8HS434	8HS638	8HS800	8HS958	8HS1114
CASE PACK	5	4	3	2	2	2
RACK DIMENSION	19 ³ / ₄ " x 10" x 5 ⁵ / ₈ " 50 x 25 x 14,3 cm	19 ³ / ₄ " x 10" x 7 ¹ / ₄ " 50 x 25 x 18,4 cm	19 ³ / ₄ " x 10" x 8 ⁷ / ₈ " 50 x 25 x 22,5 cm	19 ³ / ₄ " x 10" x 10 ¹ / ₂ " 50 x 25 x 26,7 cm	19 ³ / ₄ " x 10" x 12 ¹ / ₈ " 50 x 25 x 30,8 cm	19 ³ / ₄ " x 10" x 13 ³ / ₄ " 50 x 25 x 34,9 cm
LIST PRICE EACH	\$ 42.90	\$ 58.65	\$ 70.80	\$ 85.65	\$ 100.65	\$ 115.45

10 COMPARTMENT

3⁷/₁₆" 3.44" (8,7 cm)
MAXIMUM DIAMETER



	3 ⁵ / ₈ " 3.625" (9,2 cm)	5 ¹ / ₄ " 5.25" (13,3 cm)	6 ⁷ / ₈ " 6.875" (17,4 cm)	8 ¹ / ₂ " 8.5" (21,5 cm)	10 ¹ / ₈ " 10.125" (25,7 cm)	11 ³ / ₄ " 11.75" (29,8 cm)
MAXIMUM HEIGHT						
CODE	10HS318	10HS434	10HS638	10HS800	10HS958	10HS1114
CASE PACK	5	4	3	2	2	2
RACK DIMENSION	19 ³ / ₄ " x 10" x 5 ⁵ / ₈ " 50 x 25 x 14,3 cm	19 ³ / ₄ " x 10" x 7 ¹ / ₄ " 50 x 25 x 18,4 cm	19 ³ / ₄ " x 10" x 8 ⁷ / ₈ " 50 x 25 x 22,5 cm	19 ³ / ₄ " x 10" x 10 ¹ / ₂ " 50 x 25 x 26,7 cm	19 ³ / ₄ " x 10" x 12 ¹ / ₈ " 50 x 25 x 30,8 cm	19 ³ / ₄ " x 10" x 13 ³ / ₄ " 50 x 25 x 34,9 cm
LIST PRICE EACH	\$ 42.90	\$ 58.65	\$ 70.80	\$ 85.65	\$ 100.65	\$ 115.45

17 COMPARTMENT

2⁷/₈" 2.875" (7,3 cm)
MAXIMUM DIAMETER



	3 ⁵ / ₈ " 3.625" (9,2 cm)	5 ¹ / ₄ " 5.25" (13,3 cm)	6 ⁷ / ₈ " 6.875" (17,4 cm)	8 ¹ / ₂ " 8.5" (21,5 cm)	10 ¹ / ₈ " 10.125" (25,7 cm)	11 ³ / ₄ " 11.75" (29,8 cm)
MAXIMUM HEIGHT						
CODE	17HS318	17HS434	17HS638	17HS800	17HS958	17HS1114
CASE PACK	5	4	3	2	2	2
RACK DIMENSION	19 ³ / ₄ " x 10" x 5 ⁵ / ₈ " 50 x 25 x 14,3 cm	19 ³ / ₄ " x 10" x 7 ¹ / ₄ " 50 x 25 x 18,4 cm	19 ³ / ₄ " x 10" x 8 ⁷ / ₈ " 50 x 25 x 22,5 cm	19 ³ / ₄ " x 10" x 10 ¹ / ₂ " 50 x 25 x 26,7 cm	19 ³ / ₄ " x 10" x 12 ¹ / ₈ " 50 x 25 x 30,8 cm	19 ³ / ₄ " x 10" x 13 ³ / ₄ " 50 x 25 x 34,9 cm
LIST PRICE EACH	\$ 44.70	\$ 61.05	\$ 77.00	\$ 93.30	\$ 109.30	\$ 124.85

Base Rack Colors:

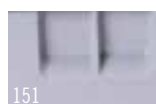

Extender Color: Soft Gray (151). Personalization available. See Camrack personalization and color coding page. Contact Customer Service for all special orders.

CAMRACK® FULL & HALF SIZE CUP RACKS

Camrack Cup Racks

Tilt feature drains water from mug or cup bases for quick and sanitary drying.

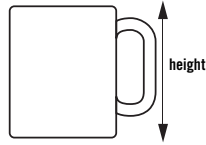

16C414

Full Size

4³/₈" X 4⁵/₁₆"
11,1 x 10,95 cm
COMPARTMENT
DIMENSIONS



16 COMPARTMENT

	2 ⁵ / ₈ " 2.625" (6,6 cm)	4 ¹ / ₄ " 4.25" (10,7 cm)	5 ⁷ / ₈ " 5.875" (14,9 cm)
MAXIMUM HEIGHT			
CODE	16C258	16C414	16C578
CASE PACK	6	5	4
RACK DIMENSION	19 ³ / ₄ " x 19 ³ / ₄ " x 4" 50 x 50 x 10,1 cm	19 ³ / ₄ " x 19 ³ / ₄ " x 5 ⁷ / ₈ " 50 x 50 x 14,3 cm	19 ³ / ₄ " x 19 ³ / ₄ " x 7 ¹ / ₄ " 50 x 50 x 18,4 cm
LIST PRICE EACH	\$ 40.45	\$ 56.35	\$ 84.25

4³/₈" X 3⁷/₁₆"
11,1 x 8,73 cm
COMPARTMENT
DIMENSIONS



20 COMPARTMENT

	2 ⁵ / ₈ " 2.625" (6,6 cm)	4 ¹ / ₄ " 4.25" (10,7 cm)
MAXIMUM HEIGHT		
CODE	20C258	20C414
CASE PACK	6	5
RACK DIMENSION	19 ³ / ₄ " x 19 ³ / ₄ " x 4" 50 x 50 x 10,1 cm	19 ³ / ₄ " x 19 ³ / ₄ " x 5 ⁷ / ₈ " 50 x 50 x 14,3 cm
LIST PRICE EACH	\$ 41.95	\$ 57.70



Half Size

4¹/₈" X 4³/₈"
10,4 x 11,1 cm
COMPARTMENT
DIMENSIONS



8 COMPARTMENT

	2 ⁵ / ₈ " 2.625" (6,6 cm)	4 ¹ / ₄ " 4.25" (10,7 cm)
MAXIMUM HEIGHT		
CODE	8HC258	8HC414
CASE PACK	6	5
RACK DIMENSION	19 ³ / ₄ " x 9 ⁷ / ₈ " x 4" 50 x 25 x 10,1 cm	19 ³ / ₄ " x 9 ⁷ / ₈ " x 5 ⁷ / ₈ " 50 x 25 x 14,3 cm
LIST PRICE EACH	\$ 28.85	\$ 47.90

4¹/₈" X 3⁷/₁₆"
10,4 x 8,73 cm
COMPARTMENT
DIMENSIONS



10 COMPARTMENT

	2 ⁵ / ₈ " 2.625" (6,6 cm)	4 ¹ / ₄ " 4.25" (10,7 cm)
MAXIMUM HEIGHT		
CODE	10HC258	10HC414
CASE PACK	6	5
RACK DIMENSION	19 ³ / ₄ " x 9 ⁷ / ₈ " x 4" 50 x 25 x 10,1 cm	19 ³ / ₄ " x 9 ⁷ / ₈ " x 5 ⁷ / ₈ " 50 x 25 x 14,3 cm
LIST PRICE EACH	\$ 28.85	\$ 47.90

Glass and Cup Keepers

Color: Beige (133).



- Raised ribs for easy draining and drying.
- Holds 20 glasses or 12 cups per layer.



Max. Glass Inside Rim Diameter:
GK2000: 2⁵/₈" (6,6 cm)



Max. Cup Inside Rim Diameter:
KK1200: 2¹⁵/₁₆" (7,4 cm)



Base Cup Rack Color: Soft Gray (151). Extender Color: Soft Gray (151). Personalization available. See Camrack personalization and color coding page. Contact Customer Service for all special orders.

CODE	SIZE	LIST PRICE EA.
Glass Keepers		
GK2000	14" x 18"	\$ 17.40
Cup Keepers		
KK1200	13 ¹⁵ / ₁₆ " x 17 ⁷ / ₈ "	16.35
Case Pack: 12		

CAMRACK® ACCESSORIES

Camrack Cover & Camdolly®

- Use to cover and protect full size Camrack dishracks filled with clean dishware.
- When used with a Camdolly, creates a portable sanitary storage system that protects contents between uses.

- Eliminates the use of messy, wasteful plastic wrap or vinyl covers.



FULL RACK COVER	
CODE	DRC2020
EXTERIOR DIMENSIONS	19 ³ / ₈ " x 19 ³ / ₈ " x 1 ⁵ / ₁₆ " (50 x 50 x 2,4 cm)
LIST PRICE EACH	\$ 55.55

Case Pack: 1 Color: Gray (180).

	CAMDOLLY	CAMDOLLY WITH HANDLE
CODE	CDR2020	CDR2020H
INTERIOR DIMENSIONS	20 ⁷ / ₈ " x 20 ⁷ / ₈ " (53 x 53 cm)	20 ⁷ / ₈ " x 20 ⁷ / ₈ " (53 x 53 cm)
EXTERIOR DIMENSIONS	21 ³ / ₈ " x 21 ³ / ₈ " x 8" (54,5 x 54,5 x 20,5 cm)	21 ³ / ₈ " x 23 ³ / ₈ " x 37" (54,5 x 59,5 x 94 cm)
LOAD CAPACITY	350 lbs. (159 kg)	350 lbs. (159 kg)
LIST PRICE EACH	\$ 175.00	\$ 280.00

Case Pack: 1 Casters: 3¹/₂" (10 cm) casters, 4 swivel, no brakes.
Color: Soft Gray (151).

Camrack IceExpress Glass Filler

- Dramatically reduces banquet set-up time.
- Fills 25 glasses with ice all at once.
- Reduces breakage and risk of contamination.
- Ice falls directly into glasses with no spills or drips.

CODE	EXTERIOR DIMENSIONS W x D x H	LIST PRICE EA.
25SWGf	20" x 20 ⁷ / ₈ " x 1 ¹ / ₄ " (50,8 x 50,8 x 3,18 cm)	\$ 88.25

Case Pack: 1 Color: Black (110).



Selecting The Right Camrack

Selecting the Right Camrack

Cambro offers multiple ways to help you quickly find the right Camrack:

1. www.cambro.com/mycamracks

To quickly find the correct Camrack, please visit www.cambro.com/mycamracks. Select the item you are sizing, enter the measurements and quantity of the item, and the right Camrack will appear on the page.

2. Cambro Catalog

Flip to the back of this section for a convenient stemware and glass sizing reference guide.

3. Cambro Sales Representatives

Contact your local Cambro representative to assist with specifying Camracks, dollies and covers that will fit your glasses and dishware. To find your local representative, refer to the back section of this catalog, visit www.cambro.com or call Cambro Customer Service at 800 833 3003.

4. Send a Sample to Cambro

Send a sample glass to:
CAMBRO
Customer Service Department
5801 Skylab Road
Huntington Beach, CA 92647
Please be sure to include complete contact information and specify if you need full-size or half-size Camracks.

Choose the correct Camrack:

1. Measure the **maximum diameter** of the glass (stemware or tumbler) to determine the number of compartments.
2. Measure the **maximum height** of the glass (stemware or tumbler) to the top edge of the rim to determine the compartment height.

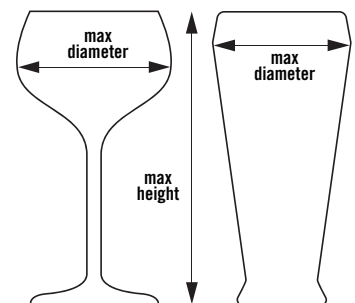

Download the Cambro App:

Find the right Camrack® for your Glassware by entering the height and maximum diameter of your glass.



CAMRACK® BASE RACKS

- For pots, pans, bowls and large prep, service and display items.
- Half racks work well for storing items at a wait station.



BR578

Full Size Base Racks

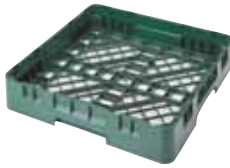

FULL BASE RACK

WITH 1 EXTENDER

WITH 2 EXTENDERS

WITH 3 EXTENDERS

CODE	BR258	BR414	BR578	BR712
INSIDE RACK HEIGHT	3¼" (8,3 cm)	4⅞" (12,4 cm)	6½" (16,5 cm)	8⅞" (20,6 cm)
OUTSIDE RACK HEIGHT	4" (10,1 cm)	5⅞" (14,3 cm)	7¼" (18,4 cm)	8⅞" (22,5 cm)
CASE PACK	6	5	4	3
RACK DIMENSION	19¾" x 19¾" x 4" 50 x 50 x 10,1 cm	19¾" x 19¾" x 5⅞" 50 x 50 x 14,3 cm	19¾" x 19¾" x 7¼" 50 x 50 x 18,4 cm	19¾" x 19¾" x 8⅞" 50 x 50 x 22,5 cm
LIST PRICE EACH	\$ 37.15	\$ 54.10	\$ 69.30	\$ 85.10

Half Size Base Racks



HALF BASE RACK

WITH 1 EXTENDER

WITH 2 EXTENDERS

WITH 3 EXTENDERS

CODE	HBR258	HBR414	HBR578	HBR712
INSIDE RACK HEIGHT	3¼" (8,3 cm)	4⅞" (12,4 cm)	6½" (16,5 cm)	8⅞" (20,6 cm)
OUTSIDE RACK HEIGHT	4" (10,1 cm)	5⅞" (14,3 cm)	7¼" (18,4 cm)	8⅞" (22,5 cm)
CASE PACK	6	5	4	3
RACK DIMENSION	19¾" x 9⅞" x 4" 50 x 25 x 10,1 cm	19¾" x 9⅞" x 5⅞" 50 x 25 x 14,3 cm	19¾" x 9⅞" x 7¼" 50 x 25 x 18,4 cm	19¾" x 9⅞" x 8⅞" 50 x 25 x 22,5 cm
LIST PRICE EACH	\$ 25.15	\$ 40.50	\$ 52.20	\$ 64.25

Full Size Hold Down Grid

Keeps lightweight smallwares in place during wash cycle. Use on full size Camrack base rack.



CRPHDG2878

HOLD DOWN GRID

CODE	CRPHDG2878
LIST PRICE EACH	\$ 27.15
Case Pack:	6
Color:	Gray (000).

Base Rack Colors:



*Full size only. Extender Color: Soft Gray (151). Personalization available. See Camrack personalization and color coding page. Contact Customer Service for all special orders.

CAMRACK® FULL SIZE PEG RACKS & TRAY RACK

Standard 9 x 9 Peg Rack

- Designed to wash varying sized plates, bowls, trays and plate covers.
- Standard peg racks hold:
 - Eighteen 10" (25,4 cm) plates
 - Twelve 12" (30,5 cm) plates
 - Twenty-seven 7½" (19 cm) plates
 or
 - Nine 14" x 18" (36 x 46 cm) trays

5 x 9 Peg Rack

- Holds standard plates in one direction or deep plates, bowls and plate covers in the other direction.
- 5 spacing configuration holds up to ten 10" bowls, deep plates, platters or plate covers.

- 9 spacing configuration holds up to:
 - Eighteen 10" (25,4 cm) plates
 - Twelve 12" (30,5 cm) plates
 - Twenty-seven 7½" (19 cm) plates
 or
 - Nine 14" x 18" (36 x 46 cm) trays

Open End Tray Rack

- Holds cafeteria trays or full-size sheet pans.
- Open-ended on one side for easy placement and removal of trays of all lengths.
- Holds up to nine trays upright.



9 X 9 PEG RACK

9 X 9 PEG RACK WITH 1 EXTENDER

5 X 9 PEG RACK

5 X 9 PEG RACK WITH 1 EXTENDER

OPEN END TRAY RACK

CODE	PR314	PR500	PR59314	PR59500	OETR314*
INSIDE RACK HEIGHT	3¼" (8,3 cm)	4⅞" (12,4 cm)	3¼" (8,3 cm)	4⅞" (12,4 cm)	3¼" (8,3 cm)
OUTSIDE RACK HEIGHT	4" (10,1 cm)	5⅝" (14,3 cm)	4" (10,1 cm)	5⅝" (14,3 cm)	4" (10,1 cm)
CASE PACK	6	5	6	5	6
LIST PRICE EACH	\$ 40.05	\$ 56.90	\$ 40.05	\$ 56.90	\$ 39.20

Color: Soft Gray (151). **Extender Color:** Soft Gray (151). Personalization available. See Camrack personalization and color coding page. Contact Customer Service for all special orders. *Extenders may be added to all Peg Racks except the OETR314.

CAMRACK FULL & HALF SIZE FLATWARE RACKS & CYLINDERS

Camrack Flatware Racks

- 8 Compartment Basket fits into a Full or Half Size Base Rack. Wire handles slide down for easy storage.

- Flatware Cylinder fits into 9-compartment Full Size Camrack and the Cambro Tray and Dish Cart, model TDCR12.



FULL FLATWARE RACK

HALF FLATWARE RACK

8 COMPARTMENT HALF FLATWARE BASKET

8 COMPARTMENT HALF FLATWARE BASKET

FLATWARE CYLINDER

CODE	FR258	HFR258	8FB434* with handles	8FBNH434* no handles	FWC56
INSIDE RACK HEIGHT	2⅝" (6,7 cm)	2⅝" (6,7 cm)	4¾" (12 cm)	4¾" (12 cm)	4½" wide (11,43 cm)
OUTSIDE RACK HEIGHT	4" (10,1 cm)	4" (10,1 cm)	7¼" (18,4 cm)	7¼" (18,4 cm)	5½" high (13,97 cm)
CASE PACK	6	6	6	6	12
LIST PRICE EACH	\$ 40.05	\$ 34.55	\$ 47.55	\$ 27.90	\$ 4.65

Color: Soft Gray (151). **Extender Color:** Soft Gray (151). **Flatware Cylinder Color:** White (148).

Personalization available. See Camrack personalization and color coding page. Contact Customer Service for all special orders. *Extenders cannot be added.

CAMRACK® COMPONENT SYSTEM

The Camrack System offers several choices for ordering the right Camracks. Please consult with your sales representative or Cambro Customer Service for all special ordering and assembly directions.

Choose Between:

1. A complete selection of pre-assembled, ready to use Camracks listed in our catalog; or
2. Custom built special order Camracks for specific needs; or
3. Individual Camrack components for distributors to stock and build racks as needed.

Base Rack Colors:

Sherwood Green (119), Soft Gray (151), Brown (167), Beige (184), Navy Blue (186), Cranberry (416), Black (110)*, Red (163)*, Blue (168)*, Teal (414)*.

Base Cup Rack Color: Soft Gray (151).

Extender Color: Soft Gray (151).

*Full size only.

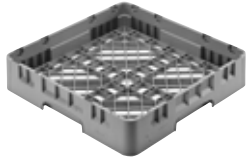

BR = Full Size Base Rack



HBR = Half Size Base Rack



E1 = Full Size Full Drop Compartment Extender



HE1 = Half Size Full Drop Compartment Extender



E2 = Full Size Half Drop Compartment Extender



HE2 = Half Size Half Drop Compartment Extender

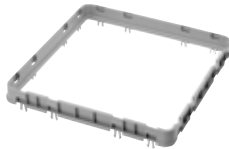

E3 = Full Size Open Extender



HE3 = Half Size Open Extender



E4 = Full Size Full Drop Stemware Extender

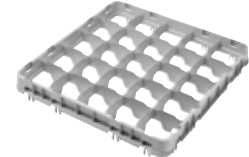

E5 = Full Size Half Drop Stemware Extender

CAMRACK COMPONENTS

Only E3 extenders may be added to E4's and E5's.

CODE	DESCRIPTION	OVERALL DIMENSIONS	COMPARTMENT	INSIDE RACK HEIGHT	CASE PACK	LIST PRICE EA.
Full Size Base Racks						
BR258	Full base rack	19¾" x 19¾" x 4" (500 x 500 x 101 mm)	18" x 18" (457 x 457 mm)	2⅝" (67 mm)	6	\$ 37.15
Half Size Base Racks						
HBR258	Half base rack	19¾" x 9⅞" x 4" (500 x 250 x 101)	18¼" x 8⅝" (464 x 213)	2⅝" (67)	6	25.15
Full Size Base Cup Racks						
16C258	16-compartment full cup rack	19¾" x 19¾" x 4" (500 x 500 x 101)	4⅜" x 4⅜" (111 x 111)	2⅝" (67)	6	40.45
20C258	20-compartment full cup rack	19¾" x 19¾" x 4" (500 x 500 x 101)	4⅜" x 3½" (111 x 89)	2⅝" (67)	6	41.95
Half Size Base Cup Racks						
8HC258	8-compartment half cup rack	19¾" x 9⅞" x 4" (500 x 250 x 101)	4⅜" x 4⅞" (105 x 113)	2⅝" (67)	6	28.85
10HC258	10-compartment half cup rack	19¾" x 9⅞" x 4" (500 x 250 x 101)	4⅜" x 3½" (105 x 89)	2⅝" (67)	6	28.85
Full Size Full Drop Extenders – E1 and G1						
9E1	9-compartment full drop extender	19⅝" x 19⅝" x 2" (499 x 499 x 51)	5⅞" x 5⅞" (150 x 150)	1⅝" (41)	12	17.10
16E1	16-compartment full drop extender	19⅝" x 19⅝" x 2" (499 x 499 x 51)	4⅜" x 4⅜" (111 x 111)	1⅝" (41)	12	18.15
20GE1	20-compartment full drop extender	19⅝" x 19⅝" x 2" (499 x 499 x 51)	3⅞" x 3⅞" (98 x 98)	1⅝" (41)	12	19.15
25E1	25-compartment full drop extender	19⅝" x 19⅝" x 2" (499 x 499 x 51)	3½" x 3½" (89 x 89)	1⅝" (41)	12	19.15
30GE1	30-compartment full drop extender	19⅝" x 19⅝" x 2" (499 x 499 x 51)	3⅞" x 3⅞" (79 x 79)	1⅝" (41)	12	19.45
36E1	36-compartment full drop extender	19⅝" x 19⅝" x 2" (499 x 499 x 51)	2⅞" x 2⅞" (73 x 73)	1⅝" (41)	12	19.45
49E1	49-compartment full drop extender	19⅝" x 19⅝" x 2" (499 x 499 x 51)	2⅞" x 2⅞" (62 x 62)	1⅝" (41)	12	19.45
Full Size Half Drop Extenders – E2 and G2						
9E2	9-compartment half drop extender	19⅝" x 19⅝" x 2" (499 x 499 x 51)	5⅞" x 5⅞" (150 x 150)	1⅝" (41)	12	16.10
16E2	16-compartment half drop extender	19⅝" x 19⅝" x 2" (499 x 499 x 51)	4⅜" x 4⅜" (111 x 111)	1⅝" (41)	12	16.10
20E2	20-compartment half drop extender (for cups only)	19⅝" x 19⅝" x 2" (499 x 499 x 51)	4⅜" x 3½" (111 x 89)	1⅝" (41)	12	14.90
20GE2	20-compartment half drop extender	19⅝" x 19⅝" x 2" (499 x 499 x 51)	3⅞" x 3⅞" (98 x 98)	1⅝" (41)	12	16.60
25E2	25-compartment half drop extender	19⅝" x 19⅝" x 2" (499 x 499 x 51)	3½" x 3½" (89 x 89)	1⅝" (41)	12	16.60
30GE2	30-compartment half drop extender	19⅝" x 19⅝" x 2" (499 x 499 x 51)	3⅞" x 3⅞" (79 x 79)	1⅝" (41)	12	17.50

CAMRACK® COMPONENT SYSTEM

CODE	DESCRIPTION	OVERALL DIMENSIONS	COMPARTMENT	INSIDE RACK HEIGHT	CASE PACK	LIST PRICE EA.
Full Size Half Drop Extenders – E2 and GE2 (continued)						
36E2	36-compartment half drop extender	19 ⁵ / ₈ " x 19 ⁵ / ₈ " x 2" (499 x 499 x 51 mm)	2 ⁷ / ₁₆ " x 2 ⁷ / ₁₆ " (73 x 73 mm)	1 ⁵ / ₈ " (41 mm)	12	\$ 17.50
49E2	49-compartment half drop extender	19 ⁵ / ₈ " x 19 ⁵ / ₈ " x 2" (499 x 499 x 51)	2 ⁷ / ₁₆ " x 2 ⁷ / ₁₆ " (62 x 62)	1 ⁵ / ₈ " (41)	12	17.50
Full Size Open Extender – E3						
E3	Open extender	19 ⁵ / ₈ " x 19 ⁵ / ₈ " x 2" (499 x 499 x 51)	18" x 18" (457 x 457)	1 ⁵ / ₈ " (41)	12	13.75
Full Size Full Drop Extender – E4						
16E4	16-compartment full drop extender	19 ⁵ / ₈ " x 19 ⁵ / ₈ " x 2" (499 x 499 x 51)	4 ³ / ₈ " x 4 ³ / ₈ " (111 x 111)	1 ⁵ / ₈ " (41)	12	19.45
25E4	25-compartment full drop extender	19 ⁵ / ₈ " x 19 ⁵ / ₈ " x 2" (499 x 499 x 51)	3 ¹ / ₂ " x 3 ¹ / ₂ " (89 x 89)	1 ⁵ / ₈ " (41)	12	22.25
36E4	36-compartment full drop extender	19 ⁵ / ₈ " x 19 ⁵ / ₈ " x 2" (499 x 499 x 51)	2 ⁷ / ₈ " x 2 ⁷ / ₈ " (73 x 73)	1 ⁵ / ₈ " (41)	12	25.15
Full Size Half Drop Extender – E5						
16E5	16-compartment half drop extender	19 ⁵ / ₈ " x 19 ⁵ / ₈ " x 2" (499 x 499 x 51)	4 ³ / ₈ " x 4 ³ / ₈ " (111 x 111)	1 ⁵ / ₈ " (41)	12	17.15
25E5	25-compartment half drop extender	19 ⁵ / ₈ " x 19 ⁵ / ₈ " x 2" (499 x 499 x 51)	3 ¹ / ₂ " x 3 ¹ / ₂ " (89 x 89)	1 ⁵ / ₈ " (41)	12	18.65
36E5	36-compartment half drop extender	19 ⁵ / ₈ " x 19 ⁵ / ₈ " x 2" (499 x 499 x 51)	2 ⁷ / ₈ " x 2 ⁷ / ₈ " (73 x 73)	1 ⁵ / ₈ " (41)	12	19.45
Half Size Full Drop Extenders – HE1						
8HE1	8-compartment full drop extender	19 ³ / ₄ " x 9 ⁷ / ₈ " x 2" (502 x 252 x 51)	4 ¹ / ₈ " x 4 ⁷ / ₁₆ " (105 x 113)	1 ⁵ / ₈ " (41)	12	15.25
10HE1	10-compartment full drop extender	19 ³ / ₄ " x 9 ⁷ / ₈ " x 2" (502 x 252 x 51)	4 ¹ / ₈ " x 3 ¹ / ₂ " (105 x 89)	1 ⁵ / ₈ " (41)	12	15.25
17HE1	17-compartment full drop extender	19 ³ / ₄ " x 9 ⁷ / ₈ " x 2" (502 x 252 x 51)	∅ 2 ¹⁵ / ₁₆ " (∅ 74)	1 ⁵ / ₈ " (41)	12	15.85
Half Size Half Drop Extenders – HE2						
8HE2	8-compartment half drop extender	19 ³ / ₄ " x 9 ⁷ / ₈ " x 2" (502 x 252 x 51)	4 ¹ / ₈ " x 4 ⁷ / ₁₆ " (105 x 113)	1 ⁵ / ₈ " (41)	12	13.70
10HE2	10-compartment half drop extender	19 ³ / ₄ " x 9 ⁷ / ₈ " x 2" (502 x 252 x 51)	4 ¹ / ₈ " x 3 ¹ / ₂ " (105 x 89)	1 ⁵ / ₈ " (41)	12	14.30
17HE2	17-compartment half drop extender	19 ³ / ₄ " x 9 ⁷ / ₈ " x 2" (502 x 252 x 51)	∅ 2 ¹⁵ / ₁₆ " (∅ 74)	1 ⁵ / ₈ " (41)	12	15.25
Half Size Open Extenders – HE3						
HE3	Open extender	19 ³ / ₄ " x 9 ⁷ / ₈ " x 2" (502 x 252 x 51)	18 ³ / ₄ " x 8 ³ / ₈ " (464 x 213)	1 ⁵ / ₈ " (41)	12	12.15

∅ = Diameter



PROMOTE YOUR BRAND – PERSONALIZED CAMRACKS®

Personalize Camracks to identify contents at a glance for accurate inventory control and selection.

Hot stamp a custom logo, information or standard content symbols, and/

or descriptions on two opposite, diagonal sides of any rack.

Or request the addition of pre-printed clips.



IMPRINT COLOR-WHITE

HOW TO ORDER A SAMPLE

1. Contact your local Cambro rep to complete and submit a sample request form to Cambro. Indicate location of hot stamp and/or clip on rack. Maximum hot stamp imprint size is **W 4" x H 1¼"**. Maximum hot stamp imprinting thickness per solid letter or logo should be no more than 4" wide.
2. If selecting custom hot stamping, provide ready-to-use artwork, in digital format only. Sample request form must be submitted to Cambro **PRIOR** to artwork being sent. If artwork is incomplete, graphic support services are available for \$ 50.00 per hour.
3. E-mail artwork to Cambro Rep or to Cambro at: letsgetpersonal@cambro.com. Title e-mail subject with logo

name and provide contact info.

File dimensions:

100% reproduction size, 300dpi resolution.

File type: Adobe® Illustrator®, Photoshop®, or QuarkXpress®.

File format: JPEG, TIFF or EPS.

Or mail artwork on a CD-ROM to: Cambro Manufacturing Company Attn: Kristie Patterson, 7601 Clay Avenue, Huntington Beach, CA 92648.

4. Questions? Contact Kristie Patterson at 714-230-4125 direct or 800-854-7631 ext. 4125.
5. Signed approval form must be faxed to Cambro customer service prior to producing product. Approval form included with each sample rack.

PERSONALIZATION CHARGES (NET)

One Time Plate Charge	\$ 100.00 (for custom hot stamp only)
Set-Up Charge	50.00
Sample Charge	50.00
Imprint Charge	1.00 per side, 2 sides max for hot stamping

FOR CLIPS

Pre-printed \$ 0.90 each net (with your order of Camracks)

STANDARD HOT STAMP SYMBOLS AND/OR DESCRIPTIONS

Step 1. Choose a symbol and corresponding letter that best fits your glassware.

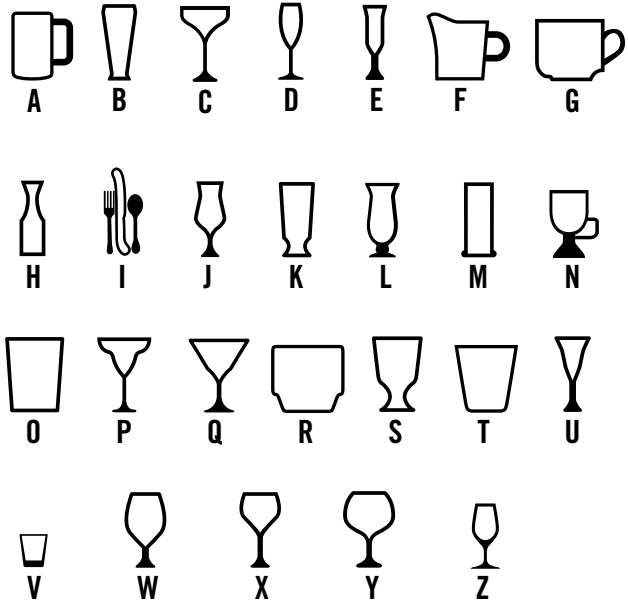

Step 2. Choose the verbiage and corresponding number that best describes your glassware. **Available in English Only.**

- | | | |
|--------------------|--------------------------|---------------------------|
| 1. Beer | 13. Flatware | 25. Rocks (Tumbler Style) |
| 2. Beer Mug | 14. Goblet | 26. Sherry |
| 3. Pilsner | 15. Grande | 27. Shot Glass |
| 4. Brandy | 16. Hi-Ball | 28. Sorbet |
| 5. Champagne | 17. Hurricane | 29. Water (Footed Style) |
| 6. Champagne Flute | 18. Iced Tea | 30. Water (Tumbler Style) |
| 7. Coffee Mug | 19. Irish Coffee | 31. White Wine |
| 8. Collins | 20. Juice | 32. Wine |
| 9. Cordial | 21. Margarita | 33. Red Wine |
| 10. Creamer | 22. Martini | 34. Port |
| 11. Cup | 23. Old Fashion | |
| 12. Decanter | 24. Rocks (Footed Style) | |

PERSONALIZATION OPTIONS

HOT STAMPING



CUSTOM LOGO AND/OR TEXT



STANDARD SYMBOL AND DESCRIPTION



STANDARD SYMBOL ONLY









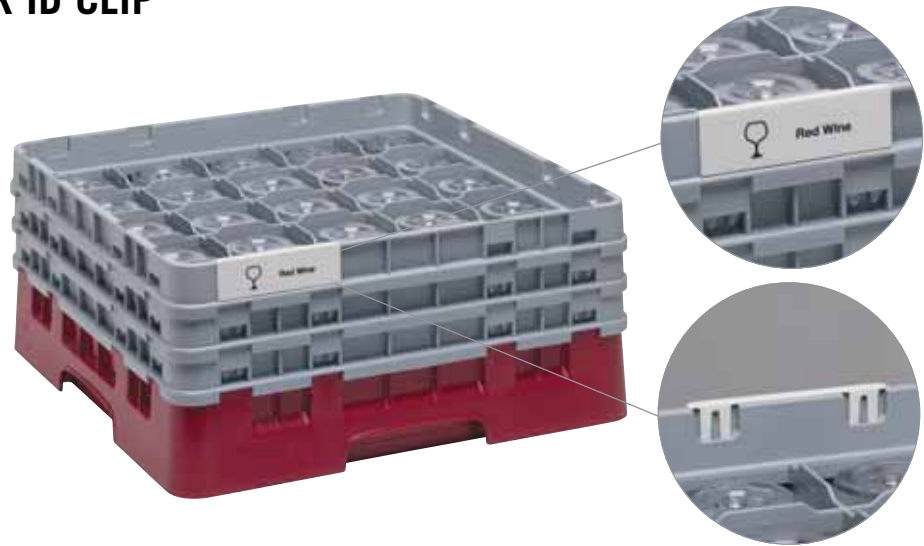



























STANDARD DESCRIPTION ONLY

CAMRACK® EXTENDER ID CLIP

- The industry's only 4-in-1 glassware management system makes inventory management quick and easy.
- Made of ABS, these clips are virtually unbreakable, and designed to withstand the high heat of commercial dishwashers.
- An economical and sustainable solution to discarding existing racks or labeling with markers, tape or wall placards.



PRE-PRINTED CLIPS (Available in 6-packs) \$ 1.85 List per clip

CODE		CODE		CODE	
	Beer CECBE6000		Goblet CECGO6000		Rocks (footed style) CECRF6000
	Beer Mug CECBM6000		Grande CECGR6000		Rocks (tumbler style) CECRT6000
	Brandy CECBR6000		Hi-Ball CECHB6000		Sherry CECSH6000
	Champagne CECCH6000		Hurricane CECHU6000		Shot Glass CECSG6000
	Champagne Flute CECCF6000		Iced Tea CECIT6000		Sorbet CECSB6000
	Coffee Mug CECCM6000		Irish Coffee CECIC6000		Water (footed style) CECWF6000
	Collins CECCL6000		Juice CECJU6000		Water (tumbler style) CECWT6000
	Cordial CECCO6000		Margarita CECMG6000		White Wine CECWW6000
	Creamer CECCR6000		Martini CECMT6000		Wine CECWI6000
	Cup CECCP6000		Old Fashion CECOF6000		Port CECPO6000
	Decanter CECDC6000		Pilsner CECPI6000		CECBL6000
	Flatware CECFL6000		Red Wine CECRW6000		Blank Clip (\$ 1.60 list per clip)

(Available in English only)

CAMDOLLIES®



- Use to transport anything from stacks of sheet pans to catering equipment.
- Reduce employee lifting and carrying and possible injury.
- Made of extremely durable plastic that will not dent, crack, rust or corrode.
- Heavy-duty casters maneuver easily over all types of terrain.
- For heavy transport needs, select models with handles and Rear Big Wheels.

Colors: Coffee Beige (157), Dark Brown (131), Black (110), Slate Blue (401).
CDR2020, CDR2020H Color: Soft Gray (151).

Caster Type

- A:** 5" casters: 2 fixed, 2 swivel, 1 with brake.
B: 3" casters: 4 swivel, no brakes.
C: 10" rear big wheels, 2 front 5" swivel casters, 1 with brake.
D: 3½" casters: 4 swivel, no brakes.

Camdollies Case Pack: 1

For Dish Racks

EXTERNAL DIM. W x D x H	21¼" x 20⅞" x 7⅞"
INTERIOR DIM. W x D	20⅞" x 20⅞"
LIST PRICE EACH	\$ 175.00

350 lbs. CAPACITY	D CASTER TYPE
-----------------------------	-------------------------



CDR2020
InStock Color: Soft Gray (151)

EXTERNAL DIM. W x D x H	20⅞" x 25¼" x 36½"
INTERIOR DIM. W x D	20⅞" x 20⅞"
LIST PRICE EACH	\$ 280.00

350 lbs. CAPACITY	D CASTER TYPE
-----------------------------	-------------------------



CDR2020H
With powder coated handle.

For 18" x 26" Trays and Sheet Pans

EXTERNAL DIM. W x D x H	20" x 31½" x 38¼"
INTERIOR DIM. W x D	18" x 26"
LIST PRICE EACH	\$ 550.00

Holds: UPC101

300 lbs. CAPACITY	A CASTER TYPE
-----------------------------	-------------------------



CD1826H

EXTERNAL DIM. W x D x H	22½" x 22½" x 8¼"
INTERIOR DIM. W x D	20⅞" x 20⅞"
LIST PRICE EACH	\$ 300.00

Also Holds: 500LCD, 350LCD, 250LCD, 1000LCD, UC1000

300 lbs. CAPACITY	B CASTER TYPE
-----------------------------	-------------------------



CD2020

EXTERNAL DIM. W x D x H	23½" x 32½" x 36½"
INTERIOR DIM. W x D	18½" x 26⅞"
LIST PRICE EACH	\$ 680.00

Holds: UPC101

300 lbs. CAPACITY	C CASTER TYPE
-----------------------------	-------------------------



CD1826HB

EXTERNAL DIM. W x D x H	22⅜" x 25⅞" x 36⅞"
INTERIOR DIM. W x D	20⅜" x 20⅞"
LIST PRICE EACH	\$ 470.00

Also Holds: 250LCD, 350LCD, 500LCD, 1000LCD

350 lbs. CAPACITY	B CASTER TYPE
-----------------------------	-------------------------



CD2020H

EXTERNAL DIM. W x D x H	26¼" x 26½" x 36⅞"
INTERIOR DIM. W x D	20½" x 20⅞"
LIST PRICE EACH	\$ 605.00

Also Holds: 250LCD, 350LCD, 500LCD

350 lbs. CAPACITY	C CASTER TYPE
-----------------------------	-------------------------



CD2020HB

For Milk Crates and #10 Can Cases

EXTERNAL DIM. W x D x H	16¼" x 21¾" x 8⅝"
INTERIOR DIM. W x D	13⅞" x 19⅞"
LIST PRICE EACH	\$ 295.00

Holds: 14" x 19" milk crates and #10 can cases

350 lbs. CAPACITY	B CASTER TYPE
-----------------------------	-------------------------



CD1420

EXTERNAL DIM. W x D x H	21⅞" x 30¾" x 8¼"
INTERIOR DIM. W x D	19⅞" x 27⅞"
LIST PRICE EACH	\$ 310.00

Holds: 14" x 19" milk crates, #10 can cases and UPC101, 300MPC, UPC400, 100MPC, UPC100, UPC300

350 lbs. CAPACITY	B CASTER TYPE
-----------------------------	-------------------------



CD2028

EXTERNAL DIM. W x D x H	16⅞" x 16⅞" x 8¼"
INTERIOR DIM. W x D	13⅞" x 13⅞"
LIST PRICE EACH	\$ 275.00

Holds: 13" x 13" milk crates

250 lbs. CAPACITY	B CASTER TYPE
-----------------------------	-------------------------



CD1313

EXTERNAL DIM. W x D x H	16" x 29" x 8¼"
INTERIOR DIM. W x D	13⅞" x 26⅞"
LIST PRICE EACH	\$ 295.00

Holds: 13" x 13" milk crates and #10 can cases

300 lbs. CAPACITY	B CASTER TYPE
-----------------------------	-------------------------



CD1327



- Use for transporting loads of up to 600 lbs.
- Large platforms for convenient loading and built-in handles for easy maneuvering.
- All models feature 5" (12,7 cm) heavy-duty casters bolted into molded-in metal backing plates.

Colors: Coffee Beige (157), Dark Brown (131), Black (110), Slate Blue (401).

Casters: 5", 2 fixed, 2 swivel, 1 with brake.

Utility Trucks Case Pack: 1

EXTERNAL DIM. W x D x H	19¾" x 32⅞" x 38½"
LOAD PLATFORM	19¾" x 29⅞"
LIST PRICE EACH	\$ 750.00

600 lbs. CAPACITY



2030UT
With chrome handle.
UTHSTP
200" long strap.

EXTERNAL DIM. W x D x H	24⅞" x 41¼" x 36¾"
LOAD PLATFORM	23⅞" x 35⅞"
LIST PRICE EACH	\$ 705.00

600 lbs. CAPACITY



2436UTH
UTHSTP
200" long strap.

EXTERNAL DIM. W x D x H	24⅞" x 41¼" x 36¾"
LOAD PLATFORM	23⅞" x 35⅞"
LIST PRICE EACH	\$ 750.00

600 lbs. CAPACITY



2436UTHS
Includes two straps.

TRAY & DISH CART / TRAY & SILVERWARE CART

Tray & Dish Cart

- Open storage compartment holds a wide variety of plates and trays.
- Use with or without detachable cutlery station.
- Made of easy-to-clean polyethylene that won't rust, peel or corrode.
- Rounded, molded-in corners protect furniture and walls.
- Molded-in handles and heavy-duty 6" (15,2 cm) swivel casters ease maneuvering.

Colors: Slate Blue (401), Coffee Beige (157), Dark Brown (131), Granite Gray (191), Granite Green (192), Black (110).

6" Casters: All swivel, 2 with brake.

Vinyl cover is not NSF listed.



Flatware cylinders and vinyl cover included with TDCR12.



Vinyl cover included for sanitary storage. TDCR12 only.



TDCR12

CODE	DESCRIPTION	DIMENSIONS L x W x H	LIST PRICE EA.
TDCR12	Cart and rack combination	38 3/8" x 22 3/4" x 41 1/4"	\$ 1,425.00
TDC2029*	Cart only	38 3/8" x 22 3/4" x 34 1/4"	1,085.00
CR12	Cutlery rack only	33" x 22 3/4" x 9"	305.00
FWC56	Flatware cylinder	—	4.65

Case Pack: 1 FWC56 Case Pack: 12 *TDC2029 is not available in Black (110).

Tray & Silverware Cart

- Use to neatly organize trays and accessories for self-service.
- Includes eight clear Camwear® food pans to hold flatware, napkins and non-perishable condiments.
- Protective vinyl cover included.

Colors: Slate Blue (401), Coffee Beige (157), Dark Brown (131), Granite Gray (191), Granite Green (192), Black (110).

6" Casters: All swivel, 2 with brake.

Vinyl cover is not NSF listed.



TC1418



CODE	DESCRIPTION	LIST PRICE EA.
TC1418	Cart w/pans & vinyl cover	\$ 1,220.00

Case Pack: 1

CODE	EXTERIOR DIMENSIONS L x W x H	WEIGHT CAPACITY	MAXIMUM TRAY SIZE	TRAY CAPACITY
TC1418	32 3/8" x 21 1/4" x 45 1/2"	500 lbs.	14" x 18"	180-200 in two stacks

CAMWEAR® PANS FOR SELF-SERVE TOP:

PAN QUANTITY, SIZE	CAPACITY
4 each, 1/3 size x 4" deep	Holds 100 knives, 100 spoons, 80 forks
4 each, 1/6 size x 4" deep	Holds variety of condiments



Vinyl cover included for sanitary storage.



S-SERIES ADJUSTABLE DISH CADDY

- Store one size dish or a combination of different sizes in a single caddy.
- Features easy-to-adjust column towers.

ADCS Colors: Black (110), Slate Blue (401), Speckled Gray (480), Dark Brown (131).

Casters: 5", 2 swivel with brakes and two 10" Easy wheels.

Vinyl cover included. Not NSF listed.

For square and rectangular plates, please contact Cambro for suggested use.

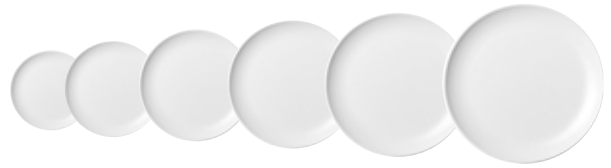

Holds plates and bowls from 4 5/8" to 13"

ADCS OVERALL DIMENSIONS
W 28 5/8" x L 37 7/8" x H 31 1/8"
(73 x 96 x 81 cm).

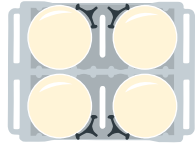

Plate sizes: 9 1/4" to 13" diam.
4 columns (60 each)
Total Capacity: 240

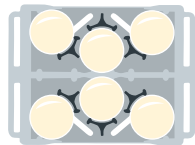

Plate sizes: 7 1/4" to 9" diam.
6 columns (60 each)
Total Capacity: 360

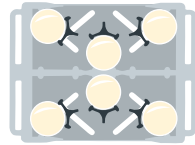
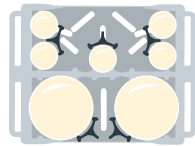
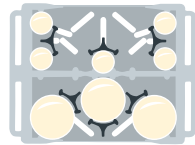

Plate sizes: 5 3/4" to 7" diam.
6 columns (45 each)
Total Capacity: 270



2 columns: 9 1/4" to 13" diam. (60 each)
5 columns: 4 3/4" (45 each)
Total Capacity: 345



3 columns: 7 1/4" to 9" diam. (60 each)
5 columns: 4 3/4" (45 each)
Total Capacity: 405

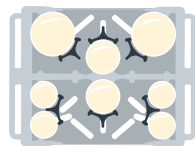

2 columns: 7 1/4" to 9" diam. (60 each)
2 columns: 5 3/4" to 7" (45 each)
4 columns: 4 3/4" (45 each)
Total Capacity: 390

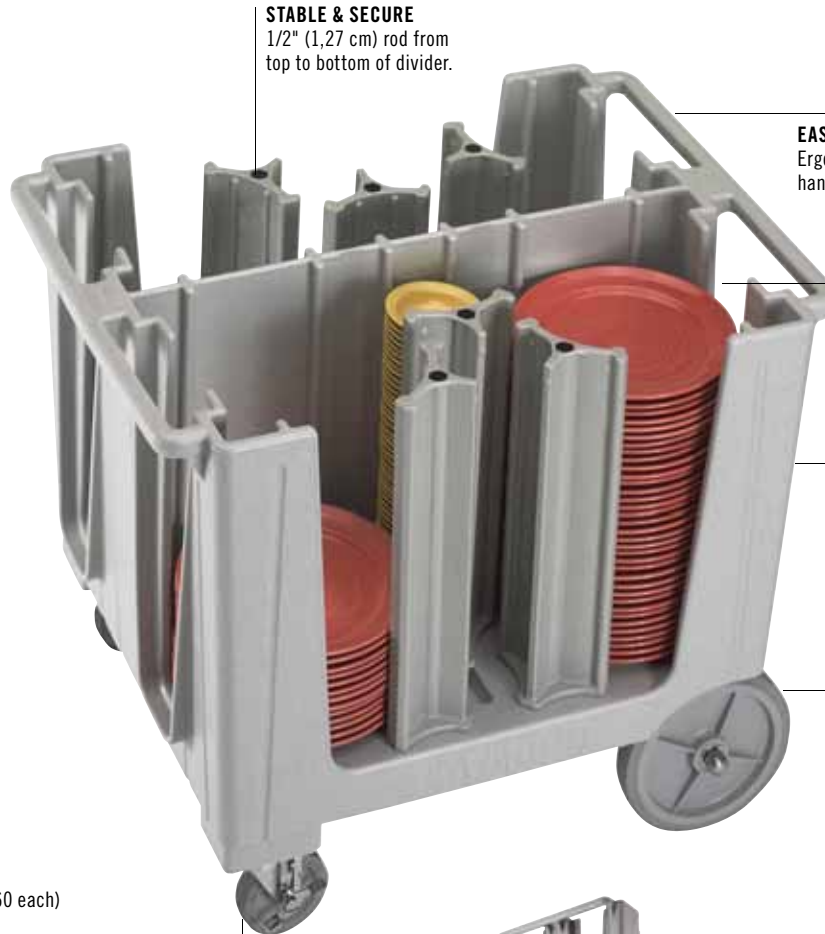

STABLE & SECURE
1/2" (1,27 cm) rod from top to bottom of divider.

EASY TO MANEUVER
Ergonomic molded-in handles on both ends.

HOLDING CAPACITY
Six 19 1/2" (49,5 cm) storage columns hold 45-60 plates per stack.

EXTREMELY DURABLE
Heavy duty polyethylene construction protects china from chipping. Won't chip, crack or rust.

REAR WHEELS
10" (25,4 cm) non-marking Easy Wheels.

FRONT CASTERS
5" (12,7 cm) swivel with brake.



A 3/4" (2 cm) plated steel rear axle allows for 500 lbs. (227 kg) load capacity.



Vinyl cover included with every dolly for sanitary storage.

CODE	ADCS
NUMBER OF DIVIDERS	6
PLATES PER COLUMN	Approximately 45-60
OVERALL DIMENSIONS W x L x H	28 5/8" x 37 7/8" x 31 1/8"
LIST PRICE EACH	\$ 1,330.00

Case Pack: 1
Colors/InStock Colors: Black (110), Speckled Gray (480).

VERSA DISH CADDIES, POKER CHIP DISH CADDIES, ADJUSTABLE TRAY & DISH CART

Versa Dish Caddies

- Secure, high-capacity storage to protect both square and round plates.
- Durable, polyethylene exterior will not rust, crack, dent or chip.
- Poker chip style offers greater access for easy plate removal.
- A 3/4" (2 cm) plated steel rear axle allows for 500 lbs. (227 kg) load capacity.
- Molded-in handles on both ends for easy transporting.
- Five-inch (12,7 cm) front swivel casters with brake and 10" (25,4 cm) non-marking rear wheels ease maneuvering.
- No assembly required.

Colors: Black (110), Dark Brown (131), Speckled Gray (480).

Casters: 2, 5" swivel with brakes and two 10" Easy Wheels.

Vinyl cover included. Not NSF listed.

DCS950 is covered by U.S. Patent D 603,120 S. DCS1125 is covered by U.S. Patent D 625,894.



DCS950 holds 5 columns of 45-60 round plates up to 9½" (24,1 cm) or 4 to 5 columns of square plates up to 8" (20,5 cm).

DCS1125 holds 4 columns of 45-60 round plates up to 11¼" (28,6 cm) or square plates up to 9½" (24,1 cm).

Poker Chip Style Dish Caddies

- Use to store and protect valuable dishware.
- Dividers are molded into the body in a standard poker chip design.
- Made of durable polyethylene that protects plates from chipping.
- Open access from two sides for easy loading and unloading.
- Rounded corners inside and out protect dishware, furniture and walls.

Colors: Black (110), Slate Blue (401), Dark Brown (131), Granite Gray (191).

Casters: 2, 5" swivel with brakes and two 10" Easy Wheels.

Vinyl cover included. Not NSF listed.



DC700



Sanitary plastic cover included and recommended for protecting clean dinnerware & trays.

Replacement covers are available through the Cambro Replacement Parts List at www.cambro.com.

Adjustable Tray & Dish Cart

- Use to store a wide variety of plates and trays.
- Move two adjustable dividers into position easily to secure trays and plates.
- Made of durable polyethylene that cushions plates and trays to prevent chipping.
- Easy to clean and won't dent, rust, chip or break.

Colors: Black (110), Slate Blue (401), Coffee Beige (157), Dark Brown (131), Granite Gray (191), Granite Green (192).

Casters: 6", all swivel, 2 with brake.

Maximum load capacity: 500 lbs.

Vinyl cover included. Not NSF listed.



TDC30



Sanitary plastic cover included.

PLATES PER COLUMN: Approximately 45-60.

TRAYS PER COLUMN: 80 trays 14" x 18".

OVERALL DIMENSIONS W x L x H: 23¼" x 38¾" x 34½".

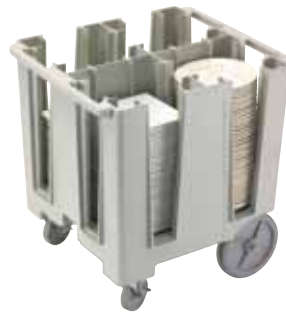
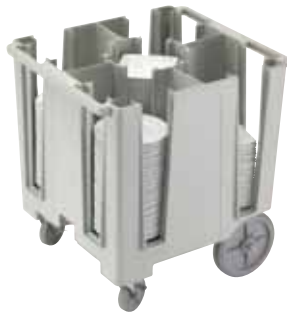

Versa Dish Caddies

CODE	DCS950	DCS1125
PLATE SIZE RANGE (ROUNDS)	8 $\frac{3}{8}$ " - 9 $\frac{1}{2}$ " (21,3 - 24,1 cm)	9 $\frac{3}{8}$ " - 11 $\frac{1}{4}$ " (24,4 - 28,6 cm)
PLATE SIZE RANGE (SQUARES)	7 $\frac{1}{4}$ " - 8" (18,4 - 20,5 cm)	8 $\frac{3}{8}$ " - 9 $\frac{1}{2}$ " (21,3 - 24,1 cm)
COLUMNS PER CADDY	5, 45-60 plates per col.	4, 45-60 plates per col.
OVERALL DIMENSIONS W x L x H	27" x 30 $\frac{1}{2}$ " x 31 $\frac{3}{4}$ "	27" x 30 $\frac{1}{2}$ " x 31 $\frac{3}{4}$ "
LIST PRICE EACH	\$ 1,045.00	\$ 1,090.00

Case Pack: 1 InStock Colors: Black (110), Speckled Gray (480).

Sanitary plastic cover included with all Cambro dish caddies.



Poker Chip Style Dish Caddies

CODE	DC575	DC700	DC825
PLATE SIZE RANGE	Up to 5 $\frac{3}{4}$ " (14,6 cm)	5 $\frac{7}{8}$ " - 7" (14,9 - 17,8 cm)	7 $\frac{1}{8}$ " - 8 $\frac{1}{4}$ " (18,1 - 21 cm)
COLUMNS PER CADDY	6, 45-60 plates per col.	6, 45-60 plates per col.	4, 45-60 plates per col.
OVERALL DIMENSIONS W x L x H	32 $\frac{3}{8}$ " x 23 $\frac{1}{2}$ " x 31 $\frac{3}{4}$ "	32 $\frac{3}{8}$ " x 23 $\frac{1}{2}$ " x 31 $\frac{3}{4}$ "	28 $\frac{3}{4}$ " x 23 $\frac{3}{4}$ " x 32"
LIST PRICE EACH	\$ 1,085.00	\$ 1,085.00	\$ 1,085.00

Case Pack: 1



Poker Chip Dish Caddies

CODE	DC1225
PLATE SIZE RANGE	11 $\frac{3}{8}$ " - 12 $\frac{1}{4}$ " (28,9 - 31,1 cm)
COLUMNS PER CADDY	4, 45-60 plates per col.
OVERALL DIMENSIONS W x L x H	32 $\frac{3}{4}$ " x 27 $\frac{1}{2}$ " x 32"
LIST PRICE EACH	\$ 1,105.00

Case Pack: 1

Adjustable Tray & Dish Cart



CODE	TDC30
NUMBER OF DIVIDERS	2
PLATES PER COLUMN	Approximately 45-60
TRAYS PER COLUMN	80 trays: 14" x 18"
OVERALL DIMENSIONS W x L x H	23 $\frac{1}{4}$ " x 38 $\frac{3}{8}$ " x 34 $\frac{1}{2}$ "
INTERNAL DIMENSIONS W x D	31" x 18" (no dividers)
LIST PRICE EACH	\$ 1,420.00

Case Pack: 1

CAMBOX® BUS BOXES



Regal



CODE	1120CBR	1520CBR
DESCRIPTION	Four compartment cutlery box	15" x 20" Cambox
DIM. W x L x H	11 $\frac{3}{8}$ " x 20 $\frac{1}{16}$ " x 3 $\frac{3}{4}$ "	15 $\frac{5}{16}$ " x 19 $\frac{15}{16}$ " x 4 $\frac{15}{16}$ "
LIST PRICE EACH	\$ 24.05	\$ 24.60

Case Pack: 12 Colors: Black (110), Dark Brown (131).



CODE	21155CBR	21157CBR	1722CBR
DESCRIPTION	15" x 21" x 5" Cambox	15" x 21" x 7" Cambox	17" x 22" Cambox
DIM. W x L x H	15 $\frac{1}{4}$ " x 20 $\frac{1}{4}$ " x 4 $\frac{15}{16}$ " (includes handle)	15 $\frac{7}{16}$ " x 20 $\frac{3}{16}$ " x 6 $\frac{15}{16}$ "	16 $\frac{7}{8}$ " x 21 $\frac{1}{8}$ " x 4 $\frac{3}{4}$ "
LIST PRICE EACH	\$ 28.85	\$ 33.25	\$ 31.95

Case Pack: 12 Colors: Black (110), Dark Brown (131).

Poly



CODE	415CBP	912CBP	1120CBP	1520CBP	1520CBPF*
DESCRIPTION	Cutlery box	Utility box	11" x 20" Cambox	15" x 20" Cambox	15" x 20" Cambox
DIM. W x L x H	4 $\frac{7}{16}$ " x 14 $\frac{3}{16}$ " x 4 $\frac{1}{8}$ "	9 $\frac{1}{16}$ " x 12 $\frac{1}{16}$ " x 5 $\frac{1}{8}$ "	11 $\frac{3}{8}$ " x 20 $\frac{1}{16}$ " x 3 $\frac{3}{4}$ "	15 $\frac{5}{16}$ " x 19 $\frac{15}{16}$ " x 4 $\frac{15}{16}$ "	15 $\frac{5}{16}$ " x 19 $\frac{15}{16}$ " x 4 $\frac{15}{16}$ "
LIST PRICE EACH	\$ 8.30	\$ 11.30	\$ 18.05	\$ 18.60	\$ 18.60

Case Pack: 12 Colors: Black (110), Dark Brown (131), Light Gray (180).
InStock Color: Light Gray (180). *1520CBPF is identical to 1520CBP except the internal surface is flat.



CODE	1621CBP	21155CBP	21157CBP	1722CBP
DESCRIPTION	15" x 20" Cambox	15" x 21" x 5" Cambox	15" x 21" x 7" Cambox	17" x 22" Cambox
DIM. W x L x H	15 $\frac{5}{8}$ " x 20 $\frac{1}{2}$ " x 4 $\frac{1}{8}$ "	15 $\frac{1}{4}$ " x 20 $\frac{1}{4}$ " x 4 $\frac{15}{16}$ " (includes handle)	15 $\frac{3}{16}$ " x 20 $\frac{3}{16}$ " x 6 $\frac{15}{16}$ "	16 $\frac{7}{8}$ " x 21 $\frac{1}{8}$ " x 4 $\frac{3}{4}$ "
LIST PRICE EACH	\$ 28.15	\$ 20.95	\$ 22.60	\$ 22.60

Case Pack: 12 Colors: Black (110), Dark Brown (131), Light Gray (180). InStock Color: Light Gray (180).

Covers



CODE	1520CBCP	1722CBCP	2115CBCP	2115CBCR
FITS	1520CBP, 1520CBPF 15 x 20 Cambox, Poly	1722CBR, 1722CBP 17 x 22 Cambox, Regal & Poly	21155CBP, 21157CBP 15 x 20 Cambox, Poly	21155CBR, 21157CBR 15 x 20 Cambox, Regal
DIM. W x L	16" x 20 $\frac{1}{2}$ "	17 $\frac{1}{16}$ " x 22 $\frac{3}{8}$ "	15 $\frac{1}{2}$ " x 20 $\frac{1}{2}$ "	15 $\frac{1}{2}$ " x 20 $\frac{1}{2}$ "
LIST PRICE EACH	\$ 15.10	\$ 27.20	\$ 15.05	\$ 15.00

Case Pack: 12 Color: White (148).



KD SERVICE CART AND KD UTILITY CART

- Versatile, durable and economically-priced carts.
- Marine rails and lightly-textured polypropylene shelves keep contents in place.
- Aluminum uprights ensure stability.
- Ships “knocked down” to minimize shipping costs.
- Easy to assemble.

Cart and Shelf Panel Set Colors:
Black (110), Speckled Gray (480).

Trash Container and Silverware Holder Color: Black (110).



CODE	BC340KD	BC331KD
DESCRIPTION	Utility Cart	Service Cart
CASTER DIA./TYPE	5", 4 swivel, no brake	4", 4 swivel, no brake
OVERALL DIM. L x D x H	40" x 21¼" x 37½"	32⅞" x 16¼" x 38"
SHELF DIM. L x D x H	31½" x 20½" x 11¼"	24⅜" x 15⅞" x 11¼"
LOAD CAPACITY	400 lbs.	300 lbs.
LIST PRICE EACH	\$ 292.00	\$ 196.00

Case Pack: 1 Colors/InStock Colors: Black (110), Speckled Gray (480).

Optional Accessories



CODE	BC331KDTC	BC331KDSH	BC340KDP
DESCRIPTION	8 gal. Trash container	2.5 gal. Silverware holder	Single shelf panel set for KD Utility Cart 1 side, 2 ends
DIM. W x D x H	13" x 9½" x 22"	13" x 9½" x 7¼"	31⅝" x 17¾" x 11¼"
LIST PRICE EACH	\$ 80.00	\$ 46.00	\$ 80.00

Case Pack: 1

SERVICE CARTS



- All-purpose versatile, durable and dependable workhorses.
- Ideal for use on the receiving dock or setting up and bussing tables.
- Made of one-piece, polyethylene with molded-in handles and shelves.
- Choose from models with open or enclosed sides.

Colors: Black (110), Slate Blue (401), Dark Brown (131), Coffee Beige (157), Granite Gray (191).

BC225, BC2254S, BC11TC and BC1115SH can be shipped by parcel carrier.



Open Carts



CODE	BC225	BC2254S	BC235
CASTER DIA./TYPE	3", 2 fixed, 2 swivel, 1 w/brake	3", 4 swivel, 1 w/brake	5", 2 fixed, 2 swivel, 1 w/brake
OVERALL DIM. L x D x H	28" x 16" x 32¼"	28" x 16" x 32¼"	37¼" x 21½" x 34⅝"
SHELF DIM. L x D x H	21¾" x 15½" x 11¼"	21¾" x 15½" x 11¼"	31½" x 20⅜" x 11⅜"
LOAD CAPACITY	350 lbs.	350 lbs.	500 lbs.
LIST PRICE EACH	\$ 605.00	\$ 625.00	\$ 830.00

Case Pack: 1



CODE	BC2354S	BC230	BC2304S
CASTER DIA./TYPE	5", 4 swivel, 1 w/brake	5", 2 fixed, 2 swivel, 1 w/brake	5", 4 swivel, 1 w/brake
OVERALL DIM. L x D x H	37¼" x 21½" x 34⅝"	33¼" x 20" x 34⅝"	33¼" x 20" x 34⅝"
SHELF DIM. L x D x H	31½" x 20⅜" x 11⅜"	27" x 19½" x 11¼"	27" x 19½" x 11¼"
LOAD CAPACITY	500 lbs.	500 lbs.	500 lbs.
LIST PRICE EACH	\$ 850.00	\$ 765.00	\$ 785.00

Case Pack: 1

Enclosed Carts



CODE	BC330	BC3304S
CASTER DIA./TYPE	5", 2 fixed, 2 swivel, 1 w/brake	5", 4 swivel, 1 w/brake
OVERALL DIM. L x D x H	33⅝" x 20" x 34⅝"	33⅝" x 20" x 34⅝"
SHELF DIM. L x D x H	27" x 18½" x 11¼"	27" x 18½" x 11¼"
LOAD CAPACITY	500 lbs.	500 lbs.
LIST PRICE EACH	\$ 825.00	\$ 845.00

Case Pack: 1

Optional Accessories



CODE	BC11TC*	BC1115SH*
DESCRIPTION	11 gal. trash container	1.75 gal. silverware holder
DIMENSIONS W x D x H	13¼" x 8⅞" x 21⅞"	14½" x 6" x 5⅝"
LIST PRICE EACH	\$ 90.00	\$ 80.00

Case Pack: 1 *BC11TC & BC1115SH will not fit KD Service or Utility Carts. BC11TC & BC1115SH are available in Black (110) and Dark Brown (131) only.



SHELVING

Key Features of Camshelving® Series

Camshelving Series Quick Reference Guide

Product Code Reference Guide

Free Camshelving Design Service

Camshelving Series Overall Length —
Quick Reference Guide

Camshelving Premium Series

Premium Series Weight Bearing Chart

Premium Series Accessories

High Density Storage Floor Track System

Camshelving Elements Series

Elements Series Weight Bearing Chart

Elements Series Accessories

Camshelving Basics Plus Series

Basics Plus Series Weight Bearing Chart

Basics Plus Series Accessories

Camshelving Wall Shelves and
StoreSafe® Shelf Extenders

Dunnage Racks

Shelving for Life



STORAGE REDEFINED.

With three distinct lines of Camshelving®, all kitchens are created equal!

Every foodservice operation deserves to be set up for maximized cost savings, space efficiency, sanitation, food safety and functionality no matter what the size or budget.

Camshelving storage systems make it all possible, helping foodservice operators optimize organization, support food safety, improve labor savings, simplify inventory management, reduce food waste, and eliminate replacement costs.



Cambo storage and transportation products that support safe food handling.



COMPONENT

Products that meet the NSF International criteria for sanitation and cleanability.



Products that help meet HACCP guidelines.



Fit for food products



Dishwasher Safe



Cadmium-free products



Recyclable polypropylene

Camshelving® is covered under the following US Patents:

D498,664 S, D508,646 S, D512,867 S, D623,929 S, D624,764 S, D648,582 S, D630,935 S, D648,159 S, D651,433 S, D648,160 S, D697,391 S, D727,715 S, D728,347 S, D728,348 S, D707,994 S, D739,989 S, D663,912 S, D736,488 S, D739,989 S, D760,519 S, US 6,981,454B2

camguard
ANTIMICROBIAL SHELF PLATES

Antimicrobial protection permanently molded into shelf plates to inhibit the growth of mold, fungus and bacteria.

CAMSHELVING®

KEY FEATURES OF ALL CAMSHELVING SERIES

Rust and Corrosion Free

Backed by a lifetime warranty against rust and corrosion, Camshelving storage systems eliminate the inconvenience and costs associated with restoring or replacing degraded shelving. Only Cambro offers Shelving for Life.



Multi Environment Use

Camshelving storage systems are designed to withstand all extreme storage applications and temperatures — impervious to moisture, chemicals, salt, food acids, and humidity. Camshelving systems can be installed anywhere and will never rust.

-36°F TO 190°F



Maximized Space Utilization

Components have been thoughtfully designed to maximize storage space, even in space-restricted areas.

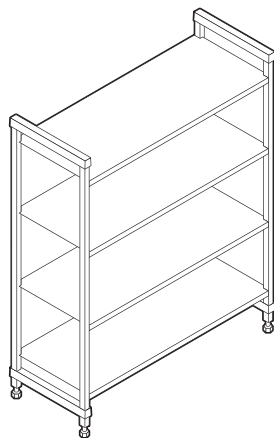

Starter Unit

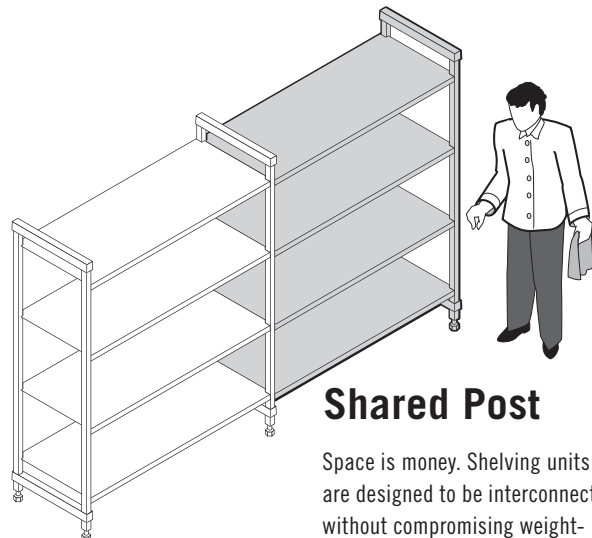

Starter + Add-On Unit

Shared Post

Space is money. Shelving units are designed to be interconnected, without compromising weight-bearing capacity all while maximizing usable storage space.

PREMIUM series

ELEMENTS series

New!

BASICS PLUS series

Easy to Clean

Cleaning shelving shouldn't be a major production. Whether daily or scheduled, cleaning can be done quickly and easily without interrupting storage space or normal, day-to-day operations.



Easy to Adjust

Each shelf can be easily and independently adjusted to accommodate a variety of storage products and packages as product and storage needs change.

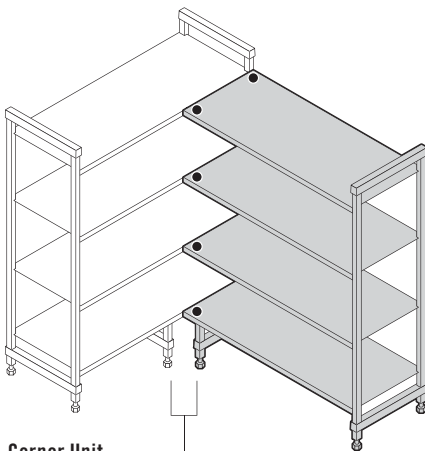

Corner Unit
Starter + Add-On Unit using 1 set of Corner Connectors per shelf and 2 Dunnage Stands.

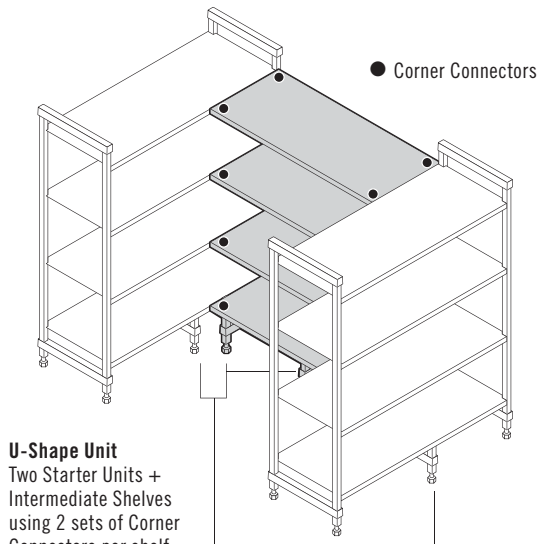

U-Shape Unit
Two Starter Units + Intermediate Shelves using 2 sets of Corner Connectors per shelf and 4 Dunnage Stands.

● Corner Connectors

Corner Shelf Space

Convert unusable space into continuous, easy-access storage areas using corner connectors.

CAMSHELVING® SERIES

QUICK REFERENCE GUIDE

Cambro offers three rust-free, non-corrosive, hygienic shelving systems that will hold up to the tough demands of commercial foodservice operations. This guide will help you choose the ideal Camshelving system for each storage area in your operation. Only Cambro offers Shelving for Life.



PREMIUM series

Storage Areas	High-volume foodservice operations with constant loading and off-loading of heavy products. Frequent and/or multiple daily deliveries. Wet Storage - Walk-in Freezers, Coolers, Warewashing Areas Dry Storage - Bulk Foods, Catering Equipment, China/Dishware, Linen, Merchandising.
Recommended For	Hotels and Casinos, Restaurants, Quick-Serve Restaurants, Schools, Colleges and Universities, Healthcare, Military, Convention Centers/Stadiums, Cruise Ships, Caterers and Banquet Centers, Corporate Dining, Convenience and Grocery Stores.
Product Material	Posts and traverses are made from a steel core with smooth polypropylene exterior. Superior strength and durable enough to withstand the heaviest loading demands.
Assembly	Molded in dovetails mean fewer parts, making it the easiest to assemble.
Weight-Bearing Capacity (based on 24" - 48" length)	Stationary Unit: 800 lbs. per shelf, 2000 lbs. per unit. Mobile Unit: 750 lbs. per unit. Corner and U-Shape Unit: 400 lbs. per shelf, 1600 lbs. per unit.
Lifetime Warranty Against Rust & Corrosion	Shelf Plates, Stationary Posts and Traverses
Unit Lengths	24", 30", 36", 42", 48", 54", 60", 72"
Unit Depths	14", 18", 21", 24"
Unit Heights	Stationary: 32", 56", 64", 72", 84" Mobile: 35", 59", 67", 75" (includes casters)
Mobile Units	YES
High Density Storage Floor Track System	YES
Bottom Shelf Dunnage Stand	YES
Shelf Rails	YES
Vertical Drying and Storage Cradle (Trays / Cutting Boards / Lids)	YES
Dome Drying and Storage Cradle	YES
Angled Drying and Storage Cradle	YES
Shelf Divider (Narrow Item Storage)	YES
Shelf Divider Bar (for Food Pans or Food Boxes)	YES
Single Shelf Sheet Pan / Tray Rack	YES
Single Shelf Security Cage	YES
Full Wrap Security Cage	YES

ACCESSORIES



ELEMENTS series

High-volume foodservice operations with constant loading and off-loading of medium to heavy products. 5-7 deliveries per week.

Wet Storage - Walk-in Freezers, Coolers, Warewashing Areas
Dry Storage - Bulk Foods, Catering Equipment, China/Dishware, Linen, Merchandising.

Hotels and Casinos, Restaurants, Quick-Serve Restaurants, Schools, Colleges and Universities, Healthcare, Military, Convention Centers/Stadiums, Cruise Ships, Caterers and Banquet Centers, Corporate Dining, Convenience and Grocery Stores.

Posts and traverses are made from a revolutionary composite material that is light in weight yet strong enough to withstand rigorous loading conditions.

Easy to assemble.

Stationary Unit: 800 lbs. per shelf, 2000 lbs. per unit.
Mobile Unit: 750 lbs. per unit.
Corner and U-Shape Unit: 400 lbs. per shelf, 1600 lbs. per unit.

Shelf Plates, Posts and Traverses

24", 30", 36", 42", 48", 54", 60", 72"

14", 18", 21", 24"

Stationary: 64", 72", 84"
Mobile: 70", 78" (includes casters)

YES

NO

YES

YES

YES

YES

YES

YES

YES

YES

YES

NO



BASICS PLUS series

Medium-volume foodservice operations with constant loading and off-loading of light to medium products. 2-5 deliveries per week.

Wet Storage - Walk-in Freezers, Coolers, Warewashing Areas
Dry Storage - Bulk Foods, Catering Equipment, China/Dishware, Linen, Merchandising.

Hotels and Casinos, Restaurants, Quick-Serve Restaurants, Schools, Colleges and Universities, Healthcare, Convention Centers/Stadiums, Caterers and Banquet Centers, Corporate Dining, Convenience Stores, Yogurt Shops and Cafés.

Posts and traverses are made from the same revolutionary composite material as Elements Series. Slim design is lighter in weight, yet durable and strong enough to withstand a wide variety of storage conditions.

Easy to assemble.

Stationary Unit: 700 lbs. per shelf, 1800 lbs. per unit.
Corner and U-Shape Unit: 300 lbs. per shelf, 1200 lbs. per unit.

Shelf Plates, Posts and Traverses

30", 36", 42", 48", 54", 60"

18", 21", 24"

Stationary: 64", 72", 84"

NO

NO

YES

NO

NO

NO

NO

YES

NO

YES

NO

NO

PRODUCT CODE REFERENCE GUIDE

Cambro's product codes are simple, making it easy to identify the type of unit or accessory required. Code numbers are composed of 3 parts.

1. **Prefix** – Defines the shelving brand and type of unit being selected.
2. **Dimensions** – Identifies the depth, length and height.
3. **Suffix** – Type and quantity of shelves.

Complete Units

CP Camshelving® Premium Series

- CPU Stationary Starter Unit
- CPA Stationary Add-On Unit
- CPMU Mobile Unit
- CPHU High Density Mobile Unit

E Camshelving Elements Series

- ESU Stationary Starter Unit
- EA Stationary Add-On Unit
- EMU Mobile Unit

CB Camshelving Basics Plus Series

- CBU Stationary Starter Unit
- CBA Stationary Add-On Unit

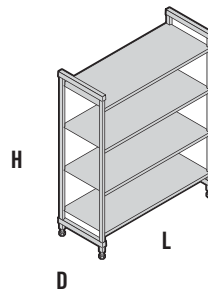
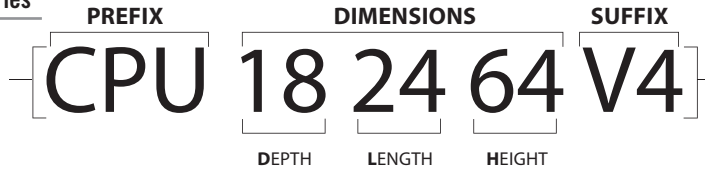

V4 4 Vented Shelves

V5 5 Vented Shelves

S4 4 Solid Shelves

S5 5 Solid Shelves

VS4 3 Vented Shelves + 1 Solid Shelf

VS5 4 Vented Shelves + 1 Solid Shelf

V4PKG* 4 Vented Shelves

V5PKG* 5 Vented Shelves

S4PKG* 4 Solid Shelves

S5PKG* 5 Solid Shelves

VS4PKG* 3 Vented Shelves + 1 Solid Shelf

VS5PKG* 4 Vented Shelves + 1 Solid Shelf

* Premium Series only - all 84" high units and 72" long units, all heights.

Post Kits and Shelf Kits

CP Camshelving® Premium Series

- CPSK Stationary Shelf Kit
- CPPK Stationary Post Kit
- CPMPK Mobile Post Kit

E Camshelving Elements Series

- ESK Stationary Shelf Kit
- EPK Stationary Post Kit
- EMSK Mobile Shelf Kit
- EMPK Mobile Post Kit

CB Camshelving Basics Plus Series

- CBSK Stationary Shelf Kit
- CBPK Stationary Post Kit

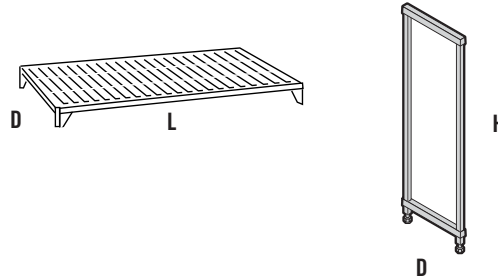
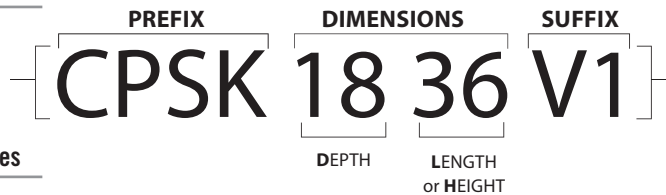

V1 1 Vented Shelf

S1 1 Solid Shelf

V4 4 Vented Shelves

V5 5 Vented Shelves

S4 4 Solid Shelves

S5 5 Solid Shelves

VS4 3 Vented Shelves + 1 Solid Shelf

VS5 4 Vented Shelves + 1 Solid Shelf

Accessories

If an accessory is used by more than 1 line of shelving, the code will start with CS.

If an accessory is only used in one line of shelving, the code will start by the prefix letters of the line.

Example: Corner Connectors:

- a. **CPCC1** = Camshelving Premium Corner Connector Set
- b. **ECC1** = Camshelving Elements Corner Connector Set
- c. **CBCC1** = Camshelving Basics Plus Corner Connector Set

FREE CAMSHELVING® DESIGN SERVICE

In order to select the most suitable and cost effective storage system, Cambro offers customized shelving illustrations using our proprietary shelving design program. Space allocation, operational flow and organizational challenges are quickly addressed when selecting the right product for the storage application. Usable storage space is maximized using the least number of units to help operators manage equipment costs.

Once all required information is received, our expert shelving consultants prepare a 2D and 3D recommended floor plan along with an itemized product list by room/area. Proposals are completed and emailed within 24-48 business day hours, depending on number of rooms and complexity. We look forward to designing the perfect storage solution for you.

It's Simple! To Get Started, Please Provide:

- Project Name
- Storage Room Type (freezer / cooler)
- Room(s) Dimensions (L x W x H)
- Doorway / Entryway Location & Dimension
- Obstructions (condenser / pipes)
- Additional Preferences / Requirements

Email: shelving@cambro.com

Call: TOLL FREE (877) 737-0663.

Visit: www.cambro.com/camshelving

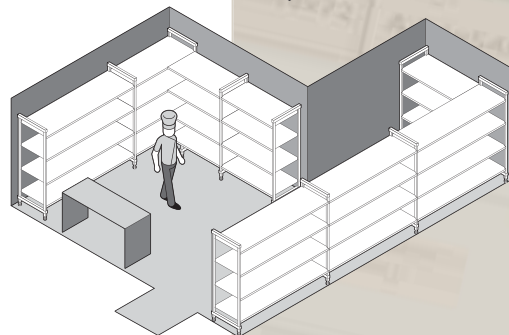
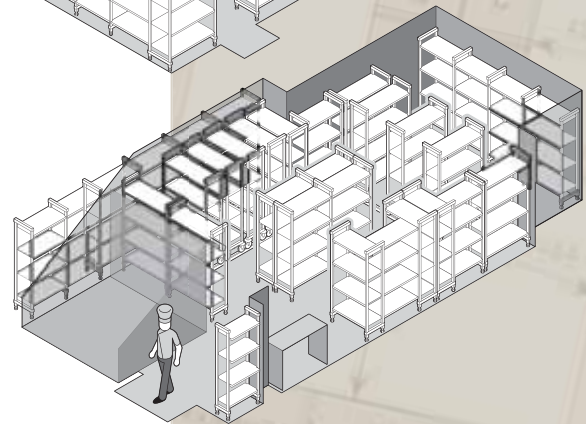
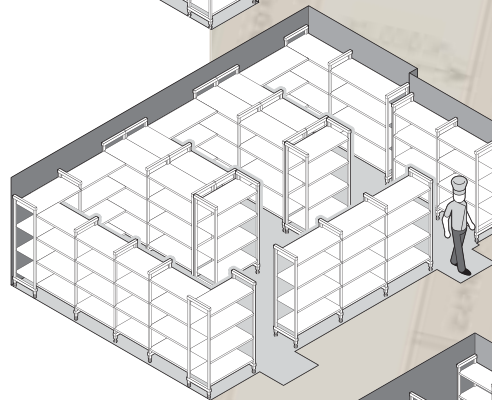
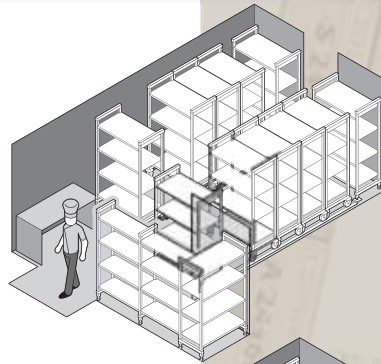

CAMSHELVING® SERIES OVERALL LENGTH – QUICK REFERENCE GUIDE

Straight Unit: Starter Unit + Add-On Unit with Shared Posts

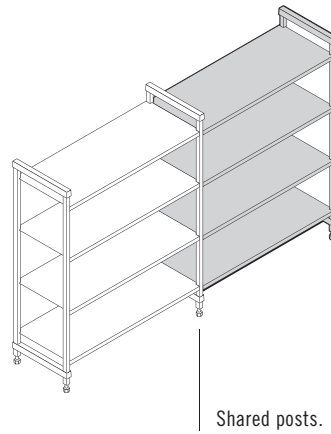
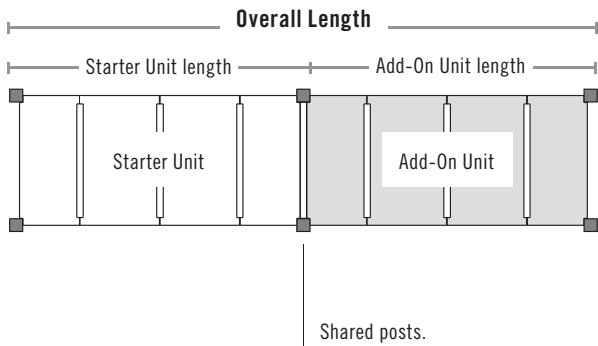

Corner Unit: Starter Unit + Add-On Unit with Corner Connectors

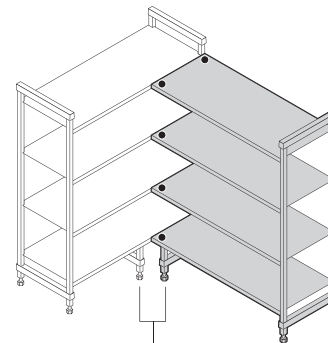
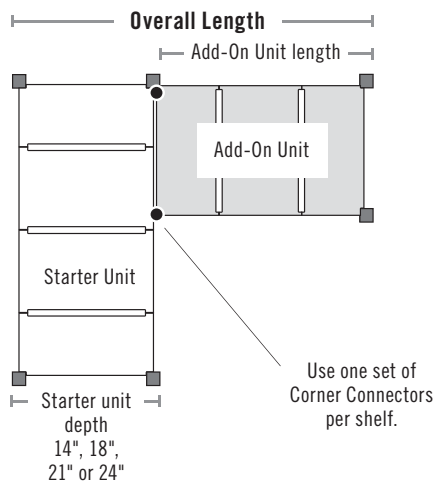

U-Shape Unit: Two Starter Units + Intermediate Shelves with Corner Connectors

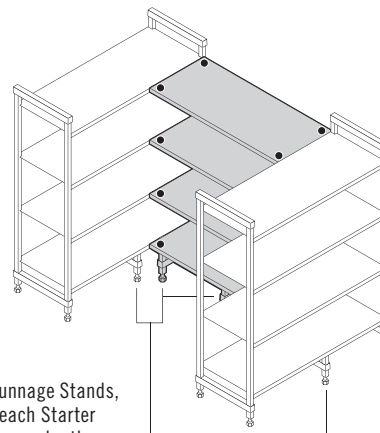
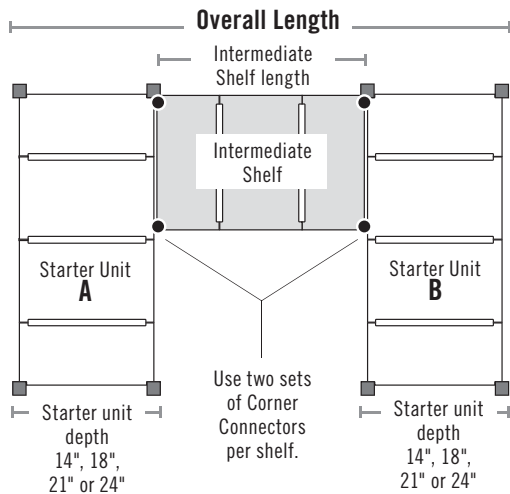

Straight Unit: Starter Unit + Add-On Unit with Shared Posts

PREMIUM / BASICS PLUS SERIES				ELEMENTS SERIES					
STARTER UNIT ACTUAL LENGTH		ADD-ON UNIT ACTUAL LENGTH		OVERALL LENGTH	STARTER UNIT ACTUAL LENGTH		ADD-ON UNIT ACTUAL LENGTH		OVERALL LENGTH
24"	+	22¼"	=	46¼"	24"	+	22"	=	46"
30"	+	28¼"	=	58¼"	30"	+	28"	=	58"
36"	+	34¼"	=	70¼"	36"	+	34"	=	70"
42"	+	40¼"	=	82¼"	42"	+	40"	=	82"
48"	+	46¼"	=	94¼"	48"	+	46"	=	94"
54"	+	52¼"	=	106¼"	54"	+	52"	=	106"
60"	+	58¼"	=	118¼"	60"	+	58"	=	118"
72"	+	70¼"	=	142¼"	72"	+	70"	=	142"

24" and 72" are not available in Camshelving Basics Plus Series.

Corner Unit: Starter Unit + Add-On Unit with Corner Connectors

PREMIUM / ELEMENTS / BASICS PLUS SERIES					PREMIUM / ELEMENTS / BASICS PLUS SERIES					PREMIUM / ELEMENTS / BASICS PLUS SERIES					
ADD-ON UNIT	ADD-ON UNIT ACTUAL LENGTH		18" STARTER UNIT DEPTH		OVERALL LENGTH	ADD-ON UNIT ACTUAL LENGTH		21" STARTER UNIT DEPTH		OVERALL LENGTH	ADD-ON UNIT ACTUAL LENGTH		24" STARTER UNIT DEPTH		OVERALL LENGTH
24"	23"	+	*18"	=	41"	23"	+	*21"	=	44"	23"	+	*24"	=	47"
30"	29"	+	*18"	=	47"	29"	+	*21"	=	50"	29"	+	*24"	=	53"
36"	35"	+	*18"	=	53"	35"	+	*21"	=	56"	35"	+	*24"	=	59"
42"	41"	+	*18"	=	59"	41"	+	*21"	=	62"	41"	+	*24"	=	65"
48"	47"	+	*18"	=	65"	47"	+	*21"	=	68"	47"	+	*24"	=	71"

24" unit not available in Camshelving Basics Plus Series.

*Actual depth.

U-Shape Unit: Two Starter Units + Intermediate Shelves with Corner Connectors

PREMIUM / ELEMENTS / BASICS PLUS SERIES					PREMIUM / ELEMENTS / BASICS PLUS SERIES					PREMIUM / ELEMENTS / BASICS PLUS SERIES					
INTERMEDIATE SHELF	INTERMEDIATE SHELF ACTUAL LENGTH		18" DEPTH STARTER UNIT A+B		OVERALL LENGTH	INTERMEDIATE SHELF ACTUAL LENGTH		21" DEPTH STARTER UNIT A+B		OVERALL LENGTH	INTERMEDIATE SHELF ACTUAL LENGTH		24" DEPTH STARTER UNIT A+B		OVERALL LENGTH
36"	34"	+	*36"	=	70"	34"	+	*42"	=	76"	34"	+	*48"	=	82"
42"	40"	+	*36"	=	76"	40"	+	*42"	=	82"	40"	+	*48"	=	88"
48"	46"	+	*36"	=	82"	46"	+	*42"	=	88"	46"	+	*48"	=	94"

*Actual depth.

CAMSHELVING® PREMIUM series

WHY CHOOSE PREMIUM?

In high volume foodservice operations with frequent deliveries and constant loading and off-loading of products, stability, strength and sanitary storage should never be compromised. Premium Series does precisely what it was designed to do – hold the heaviest products with the roughest handling, in any environment and it is the easiest to clean and adjust.



All Environments
-36°F TO 190°F

Stationary

High Density

Mobile

camguard
ANTIMICROBIAL SHELF PLATES



COMPONENT

Post Connectors, Corner Connectors, Seismic Foot, Wall Fastener, Identification Tags, Full Wrap Security Cage, Single Shelf Security Cage, Tray Slide Rack, Shelf Rails, Shelf Divider Bars, High Density Track and Extension Kits are not NSF Listed.

storage needs
HEAVY

daily deliveries
FREQUENT

CAMSHELVING® PREMIUM SERIES STATIONARY UNIT SIZES

MOBILE UNIT SIZES

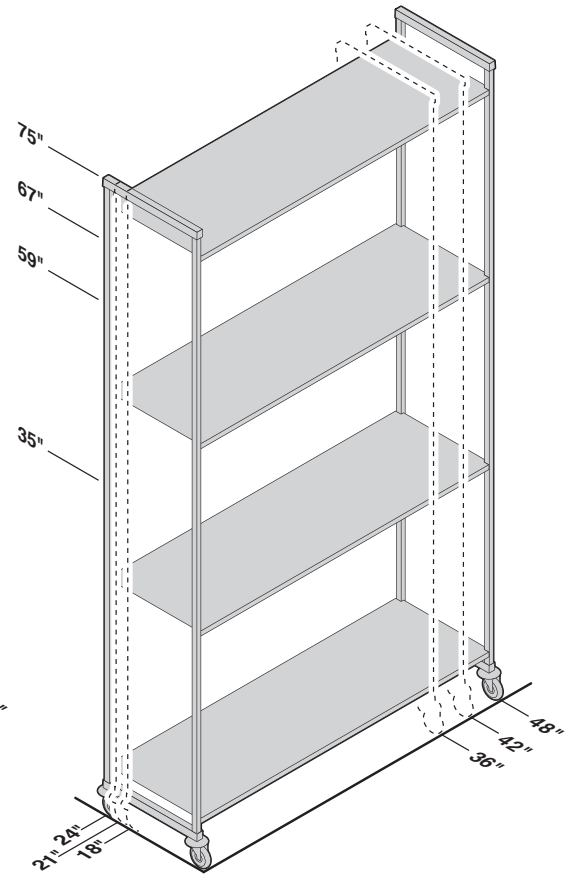
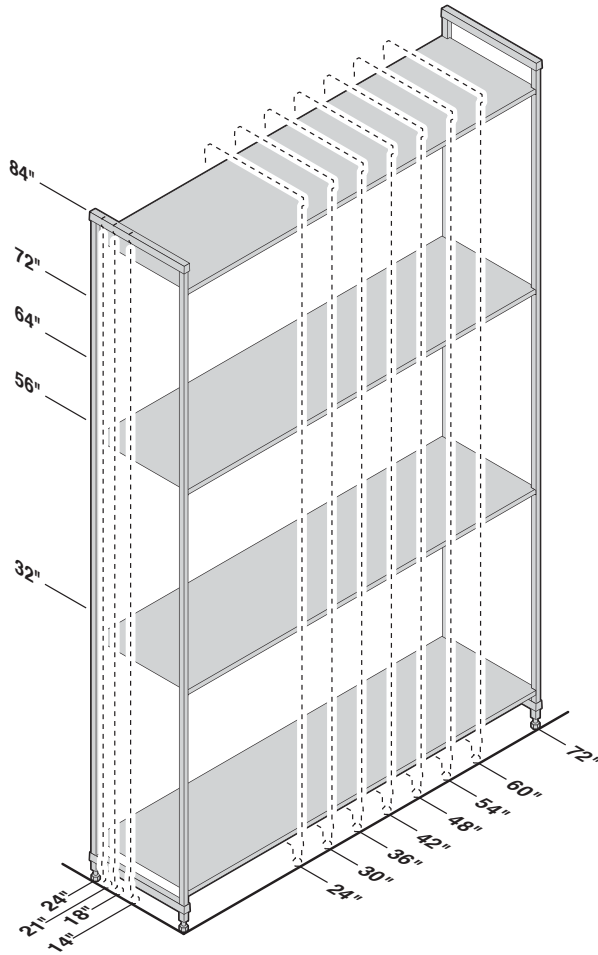

PREMIUM SERIES WEIGHT BEARING CAPACITY

Weight must be evenly distributed across the entire shelf.

		UNIT LENGTH 24" – 48"	UNIT LENGTH 54" – 72"
SINGLE UNIT	Unit only	2000 lbs.	2000 lbs.
	Shelf only	800	600
	Unit with dunnage stand*	2400	2300
	Bottom shelf with dunnage stand*	1200	900
CORNER UNIT With 2 Dunnage Stands required	Unit only	1800	—
	Shelf only	400	—
	Bottom shelf with dunnage stands*	600	—
MOBILE UNIT	Unit only**	750	—

*Dunnage Stands add stability and increase weight bearing capacity on bottom shelf only. Highly recommended for Starter Units 54" and longer, all Corner Units, U-Shape Units and units specified for heavier loads. (See page 98).

**Due to the weight bearing capacity of casters, maximum weight load on an entire Mobile Unit is 750 lbs.

CAMSHELVING® PREMIUM SERIES

Starter, Add-On and Mobile Units

These units make ordering easy and save time and labor during installation. Units ship complete in one box.* Post kits are pre-assembled at the factory, speeding up on site set up.

*Due to unit weight and size, all 84" high units and 72" long units, all heights, ship in multiple boxes of post kits (unassembled) and shelf kits.



4-Shelf Vented Stationary Starter and Add-On Units

Starter units include 2 factory assembled post kits and shelves.

Add-On units include 1 factory assembled post kit and shelves.

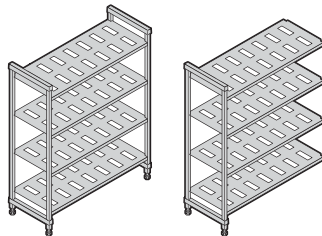

64" and 72" units ship in  1

HEIGHTS	DEPTHS	LENGTHS	
3	4	8	
64"	14"	24"	48"
72"	18"	30"	54"
84"	21"	36"	60"
	24"	42"	72"

72" long & 84" high Add-on units ship in  2

72" long & 84" high Starter units ship in  3

4-Shelf Solid Stationary Starter and Add-On Units

Starter units include 2 factory assembled post kits and shelves.

Add-On units include 1 factory assembled post kit and shelves.

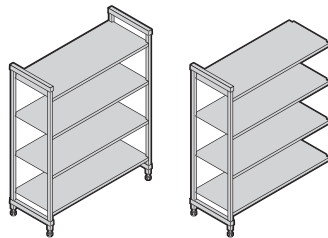

64" and 72" units ship in  1

HEIGHTS	DEPTHS	LENGTHS	
3	4	8	
64"	14"	24"	48"
72"	18"	30"	54"
84"	21"	36"	60"
	24"	42"	72"

72" long & 84" high Add-on units ship in  2

72" long & 84" high Starter units ship in  3

4-Shelf Vented and Solid Stationary Starter and Add-On Units (3 vented + 1 solid)

Starter units include 2 factory assembled post kits and shelves.

Add-On units include 1 factory assembled post kit and shelves.

Install solid shelf on bottom to prevent water/cleaning solutions from sloshing up onto stored products. Install solid shelf on top to protect product stored on lower shelves from condensation in cooler.

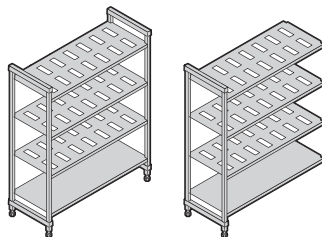

64" and 72" units ship in  1

HEIGHTS	DEPTHS	LENGTHS	
3	4	8	
64"	14"	24"	48"
72"	18"	30"	54"
84"	21"	36"	60"
	24"	42"	72"

72" long & 84" high Add-on units ship in  2

72" long & 84" high Starter units ship in  3

5-Shelf Vented Stationary Starter and Add-On Units

Starter units include 2 factory assembled post kits and shelves.

Add-On units include 1 factory assembled post kit and shelves.

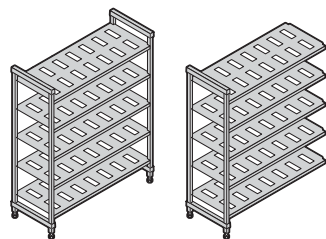

64" and 72" units ship in  1

HEIGHTS	DEPTHS	LENGTHS
3	4	8

64"	14"	24" 48"
72"	18"	30" 54"
84"	21"	36" 60"
	24"	42" 72"

72" long & 84" high
Add-on units ship in  2

72" long & 84" high
Starter units ship in  3

5-Shelf Solid Stationary Starter and Add-On Units

Starter units include 2 factory assembled post kits and shelves.

Add-On units include 1 factory assembled post kit and shelves.

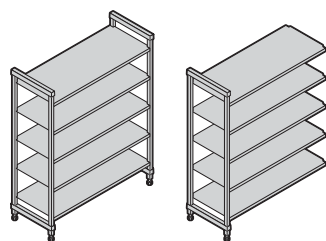

HEIGHT	DEPTHS	LENGTHS
1	4	8

84"	14"	24" 48"
	18"	30" 54"
	21"	36" 60"
	24"	42" 72"

84" Add-on units ship in  2

84" Starter units ship in  3

5-Shelf Vented and Solid Stationary Starter And Add-On Units (4 vented + 1 solid)

Starter units include 2 factory assembled post kits and shelves.

Add-On units include 1 factory assembled post kit and shelves.

Install solid shelf on bottom to prevent water/cleaning solutions from sloshing up onto stored products. Install solid shelf on top to protect product stored on lower shelves from condensation in cooler.

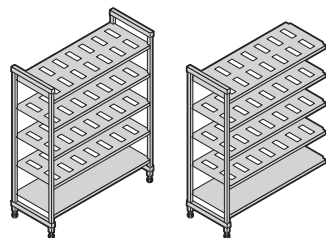

HEIGHT	DEPTHS	LENGTHS
1	4	8

84"	14"	24" 48"
	18"	30" 54"
	21"	36" 60"
	24"	42" 72"

84" Add-on units ship in  2

84" Starter units ship in  3

4 or 5-Shelf Vented Mobile Starter Units

Mobile starter units include 2 factory assembled mobile post kits, shelves and 4 premium swivel casters with total locking brake.

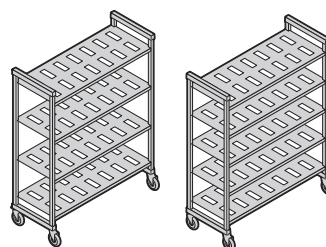

HEIGHTS*	DEPTHS	LENGTHS
2	3	3

67"	18"	36"
75"	21"	42"
	24"	48"

*Includes 5" casters.

Ships in  1



Visit the Camshelving® website at www.cambro.com/camshelving for product information, assembly videos and design layouts, or to view or download the Camshelving Specification and Price List.

PREMIUM
SERIES

V4 4-SHELF VENTED UNITS

64"
HEIGHT

Starter units include 2 factory assembled post kits and shelves. Add-on units include 1 factory assembled post kit and shelves. Units ship complete in 1 box.

Starter

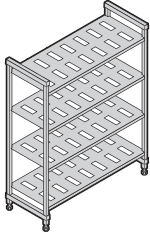

Add-On

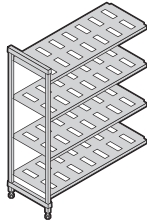

18"
DEPTH

DIMENSIONS D x L x H	CODE	LIST PRICE EA.	CODE	LIST PRICE EA.
18" x 24" x 64"	CPU182464V4	\$ 497.70	CPA182464V4	\$ 385.85
18" x 30" x 64"	CPU183064V4	562.70	CPA183064V4	450.85
18" x 36" x 64"	CPU183664V4	599.10	CPA183664V4	487.25
18" x 42" x 64"	CPU184264V4	671.90	CPA184264V4	560.05
18" x 48" x 64"	CPU184864V4	698.10	CPA184864V4	586.25
18" x 54" x 64"	CPU185464V4	770.30	CPA185464V4	658.45
18" x 60" x 64"	CPU186064V4	819.90	CPA186064V4	708.05
18" x 72" x 64"	CPU187264V4PKG	916.70	CPA187264V4PKG	804.85

PKG units ship same as 84" units.

21"
DEPTH

21" x 24" x 64"	CPU212464V4	\$ 536.50	CPA212464V4	\$ 421.75
21" x 30" x 64"	CPU213064V4	610.10	CPA213064V4	495.35
21" x 36" x 64"	CPU213664V4	653.50	CPA213664V4	538.75
21" x 42" x 64"	CPU214264V4	736.30	CPA214264V4	621.55
21" x 48" x 64"	CPU214864V4	767.50	CPA214864V4	652.75
21" x 54" x 64"	CPU215464V4	849.90	CPA215464V4	735.15
21" x 60" x 64"	CPU216064V4	906.30	CPA216064V4	791.55
21" x 72" x 64"	CPU217264V4PKG	1,018.90	CPA217264V4PKG	904.15

PKG units ship same as 84" units.

24"
DEPTH

24" x 24" x 64"	CPU242464V4	\$ 545.30	CPA242464V4	\$ 429.75
24" x 30" x 64"	CPU243064V4	622.10	CPA243064V4	506.55
24" x 36" x 64"	CPU243664V4	671.10	CPA243664V4	555.55
24" x 42" x 64"	CPU244264V4	744.50	CPA244264V4	628.95
24" x 48" x 64"	CPU244864V4	793.30	CPA244864V4	677.75
24" x 54" x 64"	CPU245464V4	861.90	CPA245464V4	746.35
24" x 60" x 64"	CPU246064V4	912.70	CPA246064V4	797.15
24" x 72" x 64"	CPU247264V4PKG	1,033.90	CPA247264V4PKG	918.35

PKG units ship same as 84" units.

PREMIUM
SERIES

V4 4-SHELF VENTED UNITS

72"
HEIGHT

Starter units include 2 factory assembled post kits and shelves. Add-on units include 1 factory assembled post kit and shelves. Units ship complete in 1 box.

Starter

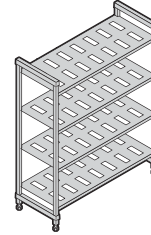

Add-On

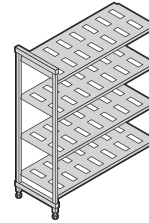

DIMENSIONS D x L x H	CODE	LIST PRICE EA.	CODE	LIST PRICE EA.
18" x 24" x 72"	CPU182472V4	\$ 502.60	CPA182472V4	\$ 388.30
18" x 30" x 72"	CPU183072V4	567.60	CPA183072V4	453.30
18" x 36" x 72"	CPU183672V4	604.00	CPA183672V4	489.70
18" x 42" x 72"	CPU184272V4	676.80	CPA184272V4	562.50
18" x 48" x 72"	CPU184872V4	703.00	CPA184872V4	588.70
18" x 54" x 72"	CPU185472V4	775.20	CPA185472V4	660.90
18" x 60" x 72"	CPU186072V4	824.80	CPA186072V4	710.50
18" x 72" x 72"	CPU187272V4PKG	921.60	CPA187272V4PKG	807.30

21" x 24" x 72"	CPU212472V4	\$ 541.10	CPA212472V4	\$ 424.05
21" x 30" x 72"	CPU213072V4	614.70	CPA213072V4	497.65
21" x 36" x 72"	CPU213672V4	658.10	CPA213672V4	541.05
21" x 42" x 72"	CPU214272V4	740.90	CPA214272V4	623.85
21" x 48" x 72"	CPU214872V4	772.10	CPA214872V4	655.05
21" x 54" x 72"	CPU215472V4	854.50	CPA215472V4	737.45
21" x 60" x 72"	CPU216072V4	910.90	CPA216072V4	793.85
21" x 72" x 72"	CPU217272V4PKG	1,023.50	CPA217272V4PKG	906.45

24" x 24" x 72"	CPU242472V4	\$ 550.50	CPA242472V4	\$ 432.35
24" x 30" x 72"	CPU243072V4	627.30	CPA243072V4	509.15
24" x 36" x 72"	CPU243672V4	676.30	CPA243672V4	558.15
24" x 42" x 72"	CPU244272V4	749.70	CPA244272V4	631.55
24" x 48" x 72"	CPU244872V4	798.50	CPA244872V4	680.35
24" x 54" x 72"	CPU245472V4	867.10	CPA245472V4	748.95
24" x 60" x 72"	CPU246072V4	917.90	CPA246072V4	799.75
24" x 72" x 72"	CPU247272V4PKG	1,039.10	CPA247272V4PKG	920.95

Color: Speckled Gray (480).

PREMIUM
SERIES

V5PKG 5-SHELF VENTED UNITS

84"
HEIGHT

Due to the unit weight, 84" units ship in separate boxes. Starter units include 2 post kits and 1 box of shelves. Add on units include 1 post kit and 1 box of shelves. Post kits require assembly.

Starter

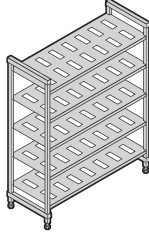

18"
DEPTH

Add-On

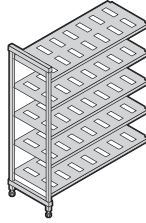

DIMENSIONS D x L x H	CODE	LIST PRICE EA.	CODE	LIST PRICE EA.
18" x 24" x 84"	CPU182484V5PKG	\$ 606.70	CPA182484V5PKG	\$ 474.60
18" x 30" x 84"	CPU183084V5PKG	687.95	CPA183084V5PKG	555.85
18" x 36" x 84"	CPU183684V5PKG	733.45	CPA183684V5PKG	601.35
18" x 42" x 84"	CPU184284V5PKG	824.45	CPA184284V5PKG	692.35
18" x 48" x 84"	CPU184884V5PKG	857.20	CPA184884V5PKG	725.10
18" x 54" x 84"	CPU185484V5PKG	947.45	CPA185484V5PKG	815.35
18" x 60" x 84"	CPU186084V5PKG	1,009.45	CPA186084V5PKG	877.35
18" x 72" x 84"	CPU187284V5PKG	1,130.45	CPA187284V5PKG	998.35

21"
DEPTH

21" x 24" x 84"	CPU212484V5PKG	\$ 653.35	CPA212484V5PKG	\$ 518.55
21" x 30" x 84"	CPU213084V5PKG	745.35	CPA213084V5PKG	610.55
21" x 36" x 84"	CPU213684V5PKG	799.60	CPA213684V5PKG	664.80
21" x 42" x 84"	CPU214284V5PKG	903.10	CPA214284V5PKG	768.30
21" x 48" x 84"	CPU214884V5PKG	942.10	CPA214884V5PKG	807.30
21" x 54" x 84"	CPU215484V5PKG	1,045.10	CPA215484V5PKG	910.30
21" x 60" x 84"	CPU216084V5PKG	1,115.60	CPA216084V5PKG	980.80
21" x 72" x 84"	CPU217284V5PKG	1,256.35	CPA217284V5PKG	1,121.55

24"
DEPTH

24" x 24" x 84"	CPU242484V5PKG	\$ 664.45	CPA242484V5PKG	\$ 528.60
24" x 30" x 84"	CPU243084V5PKG	760.45	CPA243084V5PKG	624.60
24" x 36" x 84"	CPU243684V5PKG	821.70	CPA243684V5PKG	685.85
24" x 42" x 84"	CPU244284V5PKG	913.45	CPA244284V5PKG	777.60
24" x 48" x 84"	CPU244884V5PKG	974.45	CPA244884V5PKG	838.60
24" x 54" x 84"	CPU245484V5PKG	1,060.20	CPA245484V5PKG	924.35
24" x 60" x 84"	CPU246084V5PKG	1,123.70	CPA246084V5PKG	987.85
24" x 72" x 84"	CPU247284V5PKG	1,275.20	CPA247284V5PKG	1,139.35

Color: Speckled Gray (480).

1.800.833.3003

PREMIUM
SERIES

V4 4-SHELF VENTED MOBILE UNITS

Mobile starter units include 2 factory assembled mobile post kits, shelves and 4 premium swivel casters with total locking brake. Units ship complete in 1 box.

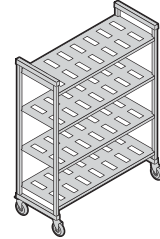

67"
HEIGHT

18"
DEPTH

CODE	DIMENSIONS D x L x H*	LIST PRICE EA.
CPMU183667V4	18" x 36" x 67"	\$ 888.30
CPMU184267V4	18" x 42" x 67"	961.10
CPMU184867V4	18" x 48" x 67"	987.30

21"
DEPTH

CPMU213667V4	21" x 36" x 67"	\$ 942.40
CPMU214267V4	21" x 42" x 67"	1,025.20
CPMU214867V4	21" x 48" x 67"	1,056.40

24"
DEPTH

CPMU243667V4	24" x 36" x 67"	\$ 960.10
CPMU244267V4	24" x 42" x 67"	1,033.50
CPMU244867V4	24" x 48" x 67"	1,082.30

75"
HEIGHT

18"
DEPTH

CODE	DIMENSIONS D x L x H*	LIST PRICE EA.
CPMU183675V4	18" x 36" x 75"	\$ 893.20
CPMU184275V4	18" x 42" x 75"	966.00
CPMU184875V4	18" x 48" x 75"	992.20

21"
DEPTH

CPMU213675V4	21" x 36" x 75"	\$ 947.40
CPMU214275V4	21" x 42" x 75"	1,030.20
CPMU214875V4	21" x 48" x 75"	1,061.40

24"
DEPTH

CPMU243675V4	24" x 36" x 75"	\$ 965.30
CPMU244275V4	24" x 42" x 75"	1,038.70
CPMU244875V4	24" x 48" x 75"	1,087.50

*Includes 5" casters.

CAMBRO USA-SHELVING

105



CAMSHELVING® PREMIUM SERIES ACCESSORIES

Bottom Shelf Dunnage Stands

Increase weight bearing capacity on bottom shelf only. Add to any shelf length. Highly recommended for starter units 54" and longer and all corner units, intermediate units and units specified for heavier load volume on and off bottom shelves.

CODE	DIMENSIONS D x H	LIST PRICE EA.
Dunnage Stand - Low		
CPDS14H6	14" x 7½"	\$ 71.10
CPDS18H6	18" x 7½"	73.45
CPDS21H6	21" x 7½"	75.30
CPDS24H6	24" x 7½"	77.20
Dunnage Stand - Tall		
CPDS14H11	14" x 11⅜"	77.00
CPDS18H11	18" x 11⅜"	79.35
CPDS21H11	21" x 11⅜"	81.20
CPDS24H11	24" x 11⅜"	83.10

Case Pack: 1 Color: Speckled Gray (480).

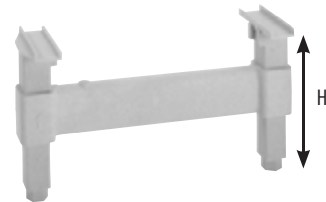

Corner Connectors

Unique patented design ensures maximum shelf space utilization. Use 1 set per shelf to connect starter and add-on units in corners. Connect 4 or 5 intermediate shelves between 2 starter units (2 sets required per shelf). Available as a single set or 8 or 10 set packs.

CODE	DESCRIPTION	LIST PRICE EA.
CPCC1	1 Set for 1 shelf	\$ 5.40
CPCC8	8 Sets for 4 shelves	43.20
CPCC10	10 Sets for 5 shelves	54.00

Color: Speckled Gray (480).

Identification Tags

Clip onto shelf traverses to clearly identify stored product. Made of highly durable plastic with a clear slide in front panel. Labels included.

CODE	DESCRIPTION	DIMENSION L x H	LIST PRICE EA.
CSID6	6" ID Tag	6" x 1"	\$ 2.25
CSID3	3" ID Tag	3" x 1"	2.25

Case Pack: 12 Color: White / Clear.



Wall Fastener

Use to secure stationary shelving unit to a wall for added safety and stability where required. Made of stainless steel. Screws not included.

CODE	DIMENSION D x L x H	LIST PRICE EA.
CSWF	2⅞" x 9⅞" x 1⅞"	\$ 25.00

Case Pack: 4 Color: Silver (000).



*Hole diameter 7/16".



CAMSHELVING® PREMIUM SERIES ACCESSORIES

Seismic Foot

Secure stationary unit posts directly to the floor for added safety and stability where required. Made of stainless steel. Bolts not included.

<u>CODE</u>	<u>DIMENSION D x L x H</u>	<u>LIST PRICE EA.</u>
CSEQ3	4" x 3 3/8" x 2 5/16"	\$ 33.00
Case Pack: 4 Color: Silver (000).		



*Hole diameter 9/16".



Premium Caster

Ideal in all areas of storage, especially coolers, freezers and/or wet areas. Made of highly durable, non-corrosive plastic with a 5" swivel, non-marking thermoplastic rubber wheel. Total locking brake locks both swivel motion and the wheel.

<u>CODE</u>	<u>SIZE</u>	<u>LIST PRICE EA.</u>
CPMCWB	5"	\$ 70.05
Case Pack: 2 Color: Gray (000).		



Donut Bumper

Offers added protection during transport and when maneuvering mobile units into place against walls or alongside other units for storage.

<u>CODE</u>	<u>DIAMETER</u>	<u>LIST PRICE EA.</u>
CPMDB	3 1/2"	\$ 9.30
Case Pack: 4 Color: Gray (000).		



Shelf Divider

Stack and separate items stored on shelves. Made of highly durable ABS plastic. Installs directly onto solid or vented shelves. Easily removable for relocating or washing. Use with Shelf Rails to prevent contents from falling off shelves.

<u>CODE</u>	<u>DIMENSION D x H</u>	<u>LIST PRICE EA.</u>
CSSD188	18" x 8"	\$ 17.00
CSSD218	21" x 8"	18.50
CSSD248	24" x 8"	20.00
Case Pack: 1 Color: Soft Gray (151).		



Shelf Divider Bars (for 24" deep shelf only)

Create a custom service or storage station for food pans, boxes or dish racks. Install straight or angled dividers directly onto shelf traverses.

<u>CODE</u>	<u>DESCRIPTION</u>	<u>LIST PRICE EA.</u>
CSDBA	Angled Divider Bar	\$ 5.80
CSDBS	Straight Divider Bar	5.80
Case Pack: 4 Color: Speckled Gray (480).		

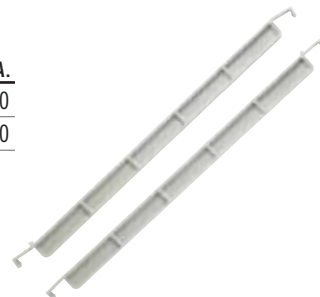

CAMSHELVING® PREMIUM SERIES ACCESSORIES

Shelf Rails

Brackets are quick and easy to install and remove. Fits shelving units 24" to 72" wide and 14" to 24" deep. Double rods provide maximum security for shelf contents.

New rails can be used with shelf dividers and drying racks. Available in kits of 3 or 4 sides to meet all foodservice needs.

Full Shelf Rail Kits

CODE	DIMENSION D x L	LIST PRICE EA.
Full Shelf Rail Kits (2 sides, 2 ends)		
CPR2436	24" x 36"	\$ 121.40
CPR2442	24" x 42"	129.30
CPR2448	24" x 48"	135.20
3/4 Shelf Rail Kits (1 side, 2 ends)		
CPR24363	24" x 36"	86.90
CPR24423	24" x 42"	90.85
CPR24483	24" x 48"	93.80

Case Pack: 1 **Color:** Soft Gray (151).

Shelf Rail kits are available in all depths and all lengths. To see the entire selection of Full & 3/4 kits, see the Camshelving Product Specification and Price List.

Single Side Rail Kits

CODE	DIMENSION LENGTH	LIST PRICE EA.
CPR24S	24"	\$ 28.70
CPR30S	30"	31.55
CPR36S	36"	34.50
CPR42S	42"	38.45
CPR48S	48"	41.40
CPR54S	54"	45.30
CPR60S	60"	48.20
CPR72S	72"	55.10

Single End Rail Kits

CODE	DIMENSION DEPTH	LIST PRICE EA.
CPR14E	14"	\$ 21.75
CPR18E	18"	23.50
CPR21E	21"	24.80
CPR24E	24"	26.20



Single Shelf Sheet Pan / Tray Rack (for 24" deep shelf only)

Holds up to 6 each full size (1826) or 12 half size (1318) sheet pans or trays. Install 1 or more units onto vented shelves, any length. High quality, lightweight aluminum material is safe for use in coolers and freezers. Made from aluminum 6463 (6000 series).

CODE	DIMENSION D x L x H	LIST PRICE EA.
CSTSR	23" x 20 ³ / ₈ " x 20"	\$ 385.00

Case Pack: 1 **Color:** Silver (000).



Full-Wrap Security Cage (for 24" deep shelf only)

Store valuable products behind locked doors. Made of heavy-duty 304 stainless steel for use in any environment. Stationary or mobile units ship complete with factory assembled post kits, 2 vented shelves, 4 premium swivel casters with total locking brake for mobile unit and 1 full wrap security cage. Bottom shelf must be vented only. Assembly required. Lock not included.



Ships standard with 2 Vented Shelf Kits

CODE	CPFWSC244860	CPU244864SUPKG	CPMU244867SUPKG
DESCRIPTION	Full-wrap Security Cage only	Full-wrap Stationary Security Unit	Full-wrap Mobile Security Unit
DIMENSION D x L x H	26 ³ / ₄ " x 50 ¹ / ₄ " x 61 ¹ / ₂ "	26 ³ / ₄ " x 50 ¹ / ₄ " x 64 ¹ / ₂ "	26 ³ / ₄ " x 50 ¹ / ₄ " x 67 ³ / ₄ "
COLOR	Silver (000)	Speckled Gray (480)	Speckled Gray (480)
LIST PRICE EA.	\$ 2,950.00	\$ 3,462.20	\$ 3,751.20

Case Pack: 1

Cage only ships in  1 Units ship in  2

CAMSHELVING® PREMIUM SERIES ACCESSORIES

Single Shelf Security Cage (for 24" deep shelf only)

Securely store valuable products on a single shelf. Made of heavy duty, 304 stainless steel for use in any environment. Requires 18" height between shelves. Install on vented shelves only. Lock not included.

CODE	DIMENSION D x L x H	LIST PRICE EA.
CSSC244818	25¼" x 42½" x 18"	\$ 640.00
Case Pack: 1 Color: Silver (000).		



Shelf Traverses

Available in single or double packs. Use a single set to add an open shelf for divider bars or drying racks. Add single traverses onto back posts for extra support when placing rolling equipment under the first shelf.

LENGTH	SINGLE PACK CODE*	LIST PRICE EA.	DOUBLE PACK CODE**	LIST PRICE EA.
24"	CPTR24	\$ 18.30	—	—
30"	CPTR30	21.95	—	—
36"	CPTR36	25.40	CPTR362PK	\$ 55.90
42"	CPTR42	29.05	CPTR422PK	63.90
48"	CPTR48	32.50	CPTR482PK	71.50
54"	CPTR54	36.00	CPTR542PK	79.20
60"	CPTR60	39.55	CPTR602PK	87.00
72"	CPTR72	46.50	—	—

*Case Pack: 1 **Case Pack: 2
Color: Speckled Gray (480).



Vertical Drying and Storage Cradle (for 24" deep shelf only)

Modular 7-slot rack designed for drying and storing trays, sheet pans, cutting boards and lids. Installs directly onto shelf traverses. Use with Shelf Rails to prevent contents from sliding off. Made of highly durable ABS plastic. Available in single or 3 pack.

CODE	DIMENSIONS D x L x H	CASE PACK	LIST PRICE EA.
CSDR7	23½" x 10¼" x 3¼"	1	\$ 56.00
CSDR73	23½" x 10¼" x 3¼"	3	168.00

Color: Soft Gray (151).



Vertical Drying and Storage Rack

Promotes sanitary drying, safe handling and efficient product organization with easy access to product. Use with Shelf Rails to prevent contents from sliding off.

Units ship complete with factory assembled mobile post kits, 6 traverses, 12 or 15 vertical drying cradles and premium swivel casters with total locking brake. Assembly required.

CODE	DIMENSIONS D x L x H	HOLDING CAPACITY	LIST PRICE EA.
CPMU244875DRPKG	24" x 48" x 75"	84 Trays	\$ 1,411.80
CPMU246075DRPKG	24" x 60" x 75"	105 Trays	1,626.30

Color: Speckled Gray (480).



48" long unit ships in  5

60" long unit ships in  6

CAMSHELVING® PREMIUM SERIES ACCESSORIES

Dome Drying and Storage Cradle (for 21" deep shelf only)

Use to dry and safely store up to 10 patient meal delivery domes or plate covers upright. Installs directly onto shelf traverses. Made of highly durable ABS plastic. Available in single or 5 pack.

CODE	DIMENSIONS D x L x H	CASE PACK	LIST PRICE EA.
CSDDC	20½" x 16⅔" x 3⅜"	1	\$ 45.00
CSDDC5	20½" x 16⅔" x 3⅜"	5	225.00

Color: Soft Gray (151).



Dome Drying and Storage Rack

Promotes sanitary drying, safe handling and efficient product organization with easy access to product.

Unit ships complete with factory assembled mobile post kits, 10 traverses, 10 dome drying cradles and premium swivel casters with total locking brake. Assembly required.

CODE	DIMENSIONS D x L x H	HOLDING CAPACITY	LIST PRICE EA.
CPMU213675DDPKG	21" x 36" x 75"	100 Domes	\$ 1,234.70

Color: Speckled Gray (480).



Ships in  3

Angled Drying and Storage Cradle (for 24" deep shelf only)

Uniquely designed cradle holds up to 8 each meal delivery pellets or use to dry, store and transport food pans and other commercial kitchen ware. Installs directly onto shelf traverses. Made of highly durable ABS plastic. Available in single or 4 pack.

CODE	DIMENSIONS D x L x H	CASE PACK	LIST PRICE EA.
CSDR8	23⅞" x 10⅞" x 6⅞"	1	\$ 45.00
CSDR84	23⅞" x 10⅞" x 6⅞"	4	180.00

Color: Soft Gray (151).



Angled Drying and Storage Rack

Promotes sanitary drying, safe handling and efficient product organization with easy access to product.

Unit ships complete with factory assembled mobile post kits, 8 traverses, 16 angled drying cradles and premium swivel casters with total locking brake. Assembly required.

CODE	DIMENSIONS D x L x H	HOLDING CAPACITY	LIST PRICE EA.
CPMU244875PDPKG	24" x 48" x 75"	128 Pellets and Bases or 16 GN 1/1 Food Pans	\$ 1,531.30

Color: Speckled Gray (480).



Ships in  5

CAMSHELVING® PREMIUM SERIES

High Density Storage Floor Track System

Maximize storage capacity by creating storage aisles in all available space. This simple system is composed of stationary starter units anchored to a raised floor track system at both ends with high density mobile units installed in between. Easy to install track requires no drilling or gluing.



High Density Mobile Units are available with factory assembled post kits, vented or solid shelves and high density casters and bumpers. Full track and extension kits ship complete with required hardware. Stationary Starter Units are required to anchor the system at both ends. Choose from a wide selection (see pages 104-105).



Stationary Unit*

High Density Mobile Units

Stationary Unit

Raised Floor Track provides a smooth and level surface to easily roll mobile units. Raised track ensures dirt will not get trapped and is easy to clean. Aluminum track and stainless steel hardware are rust resistant.



Grooved casters roll easily and securely on raised track.



Raised track connects easily to the bottom of a stationary unit that works as a system anchor. No bolts, no glue or drilling into the floor are required. Easy and fast set up.

*It is recommended to use a stationary unit for every 15' of track to further stabilize the system.

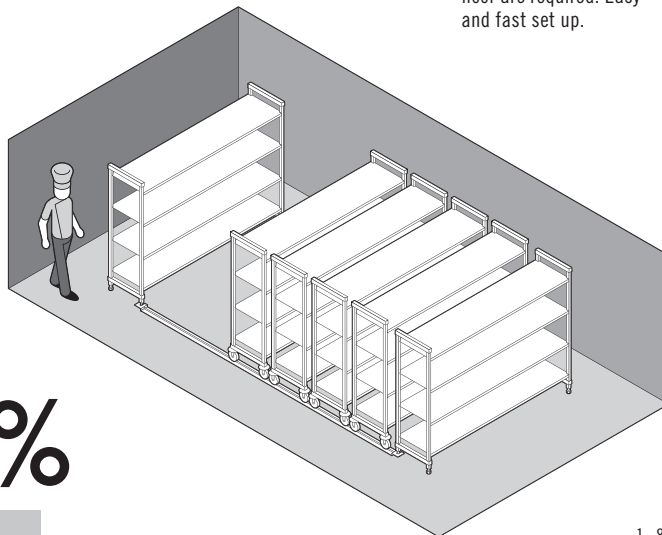
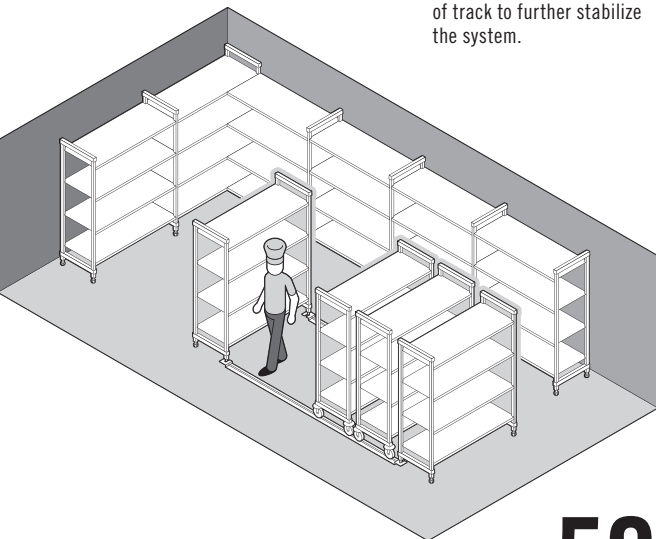

Increases Storage Capacity Up To **50%**

4-Shelf Vented High Density Mobile Starter Units

Units include 2 factory assembled mobile post kits, 4 shelves, 4 high density casters and 4 high density bumpers.

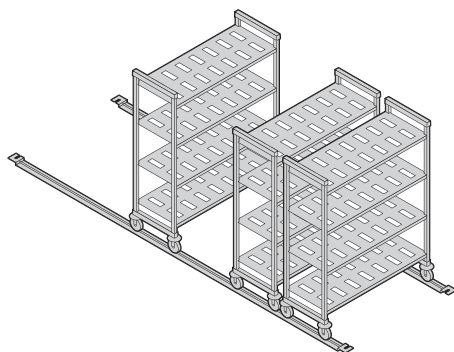

HEIGHTS*	DEPTHS	LENGTHS
2	2	5
67"	21"	36"
75"	24"	42"
		48"
		54"
		60"

*Includes 5" casters.

Ships in



4-Shelf Solid High Density Mobile Starter Units

Units include 2 factory assembled mobile post kits, 4 shelves, 4 high density casters and 4 high density bumpers.

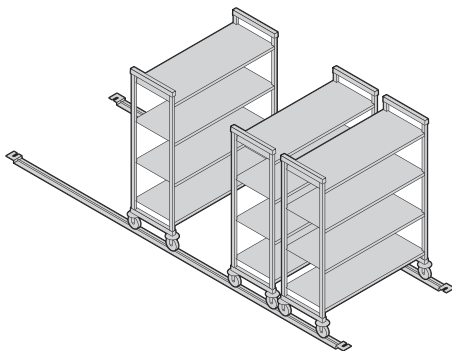

HEIGHTS*	DEPTHS	LENGTHS
2	2	5
67"	21"	36"
75"	24"	42"
		48"
		54"
		60"

*Includes 5" casters.

Ships in



Full Track and Extension Kits

Aluminum raised track kits and track extensions ship complete in 1 box. Each kit includes all stainless steel hardware necessary to complete a floor installation.

It is highly recommended to install a stationary starter unit every 15' of track to further stabilize the system.



Full Track LENGTHS	Track Extension LENGTHS
3	3
10'	4.5'
12'	5'
14.5'	6'

Ships in



High Density Caster with Donut Bumper

Grooved caster rolls easily and securely on raised track. Donut bumper protects mobile units from coming into direct contact with each other.



V4

4-SHELF VENTED HIGH DENSITY MOBILE UNITS

Units include 2 factory assembled mobile post kits, 4 shelves, 4 high density casters and 4 high density bumpers. Units ship complete in 1 box.

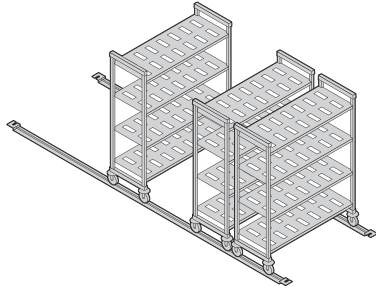

67"
HEIGHT

21"
DEPTH

24"
DEPTH

75"
HEIGHT

21"
DEPTH

24"
DEPTH

CODE	DIMENSIONS D x L x H*	LIST PRICE EA.
CPHU213667V4	21" x 36" x 67"	\$ 878.00
CPHU214267V4	21" x 42" x 67"	960.80
CPHU214867V4	21" x 48" x 67"	992.00
CPHU215467V4	21" x 54" x 67"	1,074.40
CPHU216067V4	21" x 60" x 67"	1,130.80

CPHU243667V4	24" x 36" x 67"	\$ 895.70
CPHU244267V4	24" x 42" x 67"	969.10
CPHU244867V4	24" x 48" x 67"	1,017.90
CPHU245467V4	24" x 54" x 67"	1,086.50
CPHU246067V4	24" x 60" x 67"	1,137.30

CODE	DIMENSIONS D x L x H*	LIST PRICE EA.
CPHU213675V4	21" x 36" x 75"	\$ 883.00
CPHU214275V4	21" x 42" x 75"	965.80
CPHU214875V4	21" x 48" x 75"	997.00
CPHU215475V4	21" x 54" x 75"	1,079.40
CPHU216075V4	21" x 60" x 75"	1,135.80

CPHU243675V4	24" x 36" x 75"	\$ 900.90
CPHU244275V4	24" x 42" x 75"	974.30
CPHU244875V4	24" x 48" x 75"	1,023.10
CPHU245475V4	24" x 54" x 75"	1,091.70
CPHU246075V4	24" x 60" x 75"	1,142.50

S4

4-SHELF SOLID HIGH DENSITY MOBILE UNITS

Units include 2 factory assembled mobile post kits, 4 shelves, 4 high density casters and 4 high density bumpers. Units ship complete in 1 box.

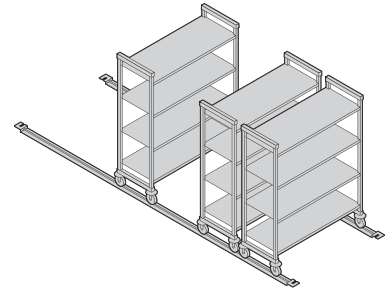

CODE	DIMENSIONS D x L x H*	LIST PRICE EA.
CPHU213667S4	21" x 36" x 67"	\$ 901.00
CPHU214267S4	21" x 42" x 67"	985.40
CPHU214867S4	21" x 48" x 67"	1,025.60
CPHU215467S4	21" x 54" x 67"	1,109.40
CPHU216067S4	21" x 60" x 67"	1,167.60

CPHU243667S4	24" x 36" x 67"	\$ 927.50
CPHU244267S4	24" x 42" x 67"	1,001.90
CPHU244867S4	24" x 48" x 67"	1,054.30
CPHU245467S4	24" x 54" x 67"	1,129.50
CPHU246067S4	24" x 60" x 67"	1,186.30

CODE	DIMENSIONS D x L x H*	LIST PRICE EA.
CPHU213675S4	21" x 36" x 75"	\$ 906.00
CPHU214275S4	21" x 42" x 75"	990.40
CPHU214875S4	21" x 48" x 75"	1,030.60
CPHU215475S4	21" x 54" x 75"	1,114.40
CPHU216075S4	21" x 60" x 75"	1,172.60

CPHU243675S4	24" x 36" x 75"	\$ 932.70
CPHU244275S4	24" x 42" x 75"	1,007.10
CPHU244875S4	24" x 48" x 75"	1,059.50
CPHU245475S4	24" x 54" x 75"	1,134.70
CPHU246075S4	24" x 60" x 75"	1,191.50

Color: Speckled Gray (480). *Includes 5" casters.

Full Track and Extension Kits

Aluminum raised track kits and track extensions ship complete in 1 box. Each kit includes all stainless steel hardware necessary to complete a floor installation.

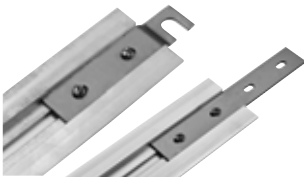

It is highly recommended to install a stationary starter unit every 15' of track to further stabilize the system.

CODE	DESCRIPTION	CASE PACK	LIST PRICE EA.
Full Track Kit			
CSMHDTK10	10' Track for 3 Mobile Units*	1	\$ 620.00
CSMHDTK12	12' Track for 4 Mobile Units*	1	715.00
CSMHDTK145	14.5' Track for 5 Mobile Units*	1	805.00
Track Extension Kit			
CSMHDTKE4	4.5' Track Extension	1	233.90
CSMHDTKE5	5' Track Extension	1	249.75
CSMHDTKE6	6' Track Extension	1	296.50

Color: Silver (000). *Based on 24" deep mobile units.

High Density Caster with Donut Bumper



CODE	SIZE	LIST PRICE EA.
CPMCHD	5"	\$ 53.95
Case Pack: 2		Color: Gray (000).



CAMSHELVING® ELEMENTS series

WHY CHOOSE ELEMENTS?

Made from a revolutionary, extremely strong composite material with a smooth, easy to clean surface. Elements Series is stronger than common wire shelving. It's lighter in weight than Camshelving Premium Series and totally impervious to moisture, chemicals and liquids that can destroy shelving over time. Elements Series is designed for medium to heavy storage use in freezers, coolers, dry storage or warewashing areas. It easily supports the performance demands of a busy foodservice operation.



All Environments
-36°F TO 190°F

Stationary

Mobile

camguard
ANTIMICROBIAL SHELF PLATES



COMPONENT

Post Connectors, Corner Connectors, Seismic Foot, Wall Fastener, Identification Tags, Single Shelf Security Cage, Tray Slide Rack, and Shelf Divider Bars are not NSF Listed.

storage needs

MEDIUM to HEAVY

weekly deliveries

5 – 7

CAMSHELVING® ELEMENTS SERIES
STATIONARY UNIT SIZES

MOBILE UNIT SIZES

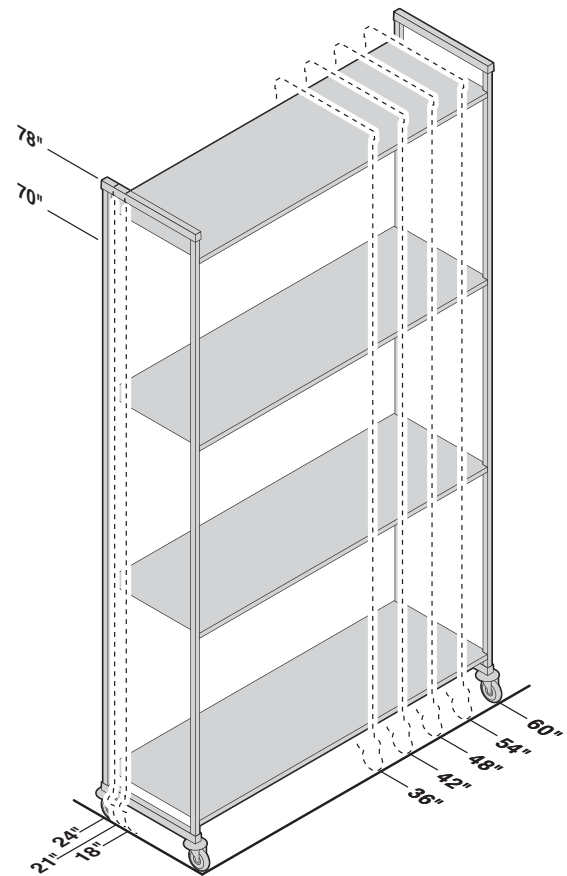
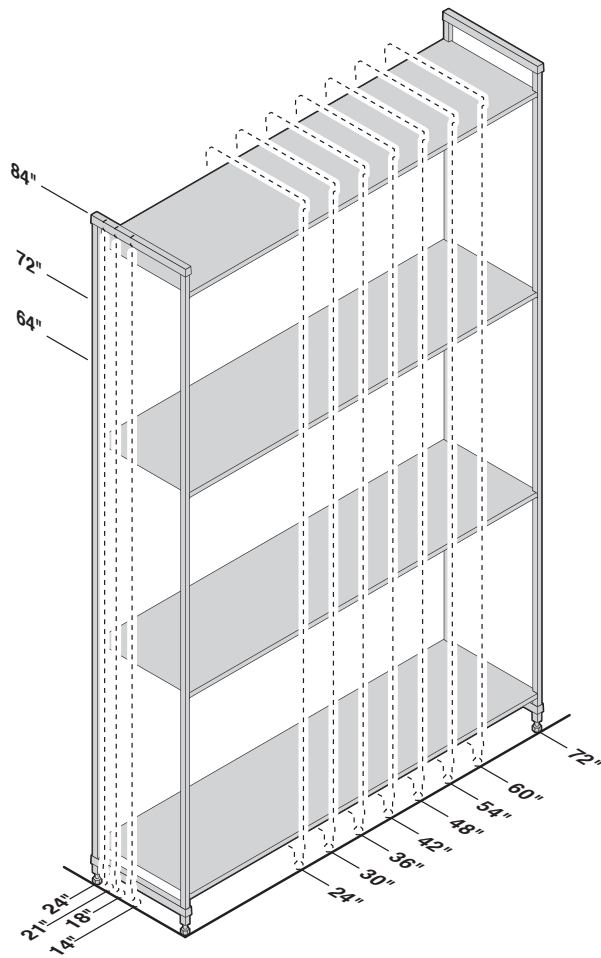

ELEMENTS SERIES WEIGHT BEARING CAPACITY

Weight must be evenly distributed across the entire shelf.

		UNIT LENGTH 24" – 48"	UNIT LENGTH 54" – 72"
SINGLE UNIT	Unit only	2000 lbs.	2000 lbs.
	Shelf only	800	600
	Unit with dunnage stand*	2400	2300
	Bottom shelf with dunnage stand*	1200	900
CORNER UNIT With 2 Dunnage Stands required	Unit only	1800	—
	Shelf only	400	—
	Bottom shelf with dunnage stands*	600	—
MOBILE UNIT	Unit only**	750	—

*Dunnage Stands add stability and increase weight bearing capacity on bottom shelf only. Highly recommended for Starter Units 54" and longer, all Corner Units, U-Shape Units and units specified for heavier loads. (See page 98).

**Due to the weight bearing capacity of casters, maximum weight load on an entire Mobile Unit is 750 lbs.

CAMSHELVING® ELEMENTS SERIES

Starter, Add-On and Mobile Units

These units make ordering easy and save time and labor during installation. Units ship complete in one box. Post kits are pre-assembled at the factory, speeding up on site set up.



4-Shelf Vented Stationary Starter and Add-On Units

Starter units include 2 factory assembled post kits and shelves.
Add-On units include 1 factory assembled post kit and shelves.

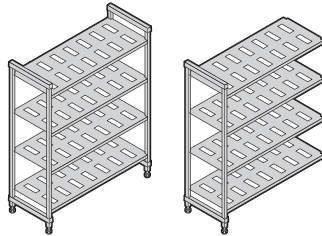

HEIGHTS	DEPTHS	LENGTHS	
3	4	8	
64"	14"	24"	48"
72"	18"	30"	54"
84"	21"	36"	60"
	24"	42"	72"

Ships in  1

4-Shelf Solid Stationary Starter and Add-On Units

Starter units include 2 factory assembled post kits and shelves.
Add-On units include 1 factory assembled post kit and shelves.

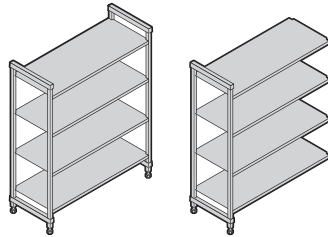

HEIGHTS	DEPTHS	LENGTHS	
3	4	8	
64"	14"	24"	48"
72"	18"	30"	54"
84"	21"	36"	60"
	24"	42"	72"

Ships in  1

4-Shelf Vented and Solid Stationary Starter and Add-On Units (3 vented + 1 solid)

Starter units include 2 factory assembled post kits and shelves.
Add-On units include 1 factory assembled post kit and shelves.
Install solid shelf on bottom to prevent water/cleaning solutions from sloshing up onto stored products. Install solid shelf on top to protect product stored on lower shelves from condensation in cooler.

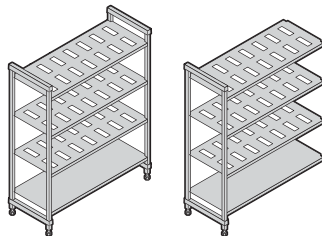

HEIGHTS	DEPTHS	LENGTHS	
3	4	8	
64"	14"	24"	48"
72"	18"	30"	54"
84"	21"	36"	60"
	24"	42"	72"

Ships in  1

5-Shelf Vented Stationary Starter and Add-On Units

Starter units include 2 factory assembled post kits and shelves.

Add-On units include 1 factory assembled post kit and shelves.

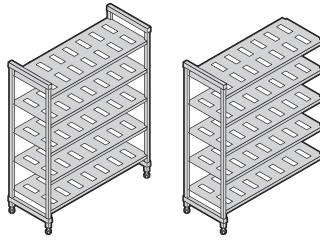

HEIGHTS	DEPTHS	LENGTHS	
3	4	8	
64"	14"	24"	48"
72"	18"	30"	54"
84"	21"	36"	60"
	24"	42"	72"

Ships in  1

5-Shelf Solid Stationary Starter and Add-On Units

Starter units include 2 factory assembled post kits and shelves.

Add-On units include 1 factory assembled post kit and shelves.

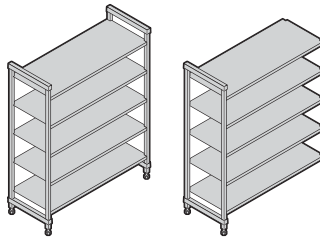

HEIGHT	DEPTHS	LENGTHS	
1	4	8	
84"	14"	24"	48"
	18"	30"	54"
	21"	36"	60"
	24"	42"	72"

Ships in  1

5-Shelf Vented and Solid Stationary Starter And Add-On Units (4 vented + 1 solid)

Starter units include 2 factory assembled post kits and shelves.

Add-On units include 1 factory assembled post kit and shelves.

Install solid shelf on bottom to prevent water/cleaning solutions from sloshing up onto stored products.
Install solid shelf on top to protect product stored on lower shelves from condensation in cooler.

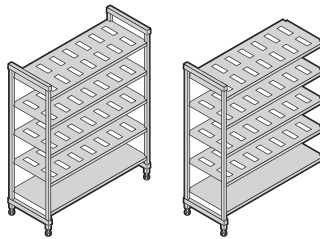

HEIGHT	DEPTHS	LENGTHS	
1	4	8	
84"	14"	24"	48"
	18"	30"	54"
	21"	36"	60"
	24"	42"	72"

Ships in  1

4 or 5-Shelf Vented Mobile Starter Units

Mobile starter units include 2 factory assembled mobile post kits, shelves and 4 premium swivel casters with total locking brake.

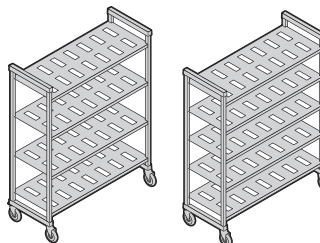

HEIGHTS*	DEPTHS	LENGTHS	
2	3	5	
70"	18"	36"	54"
78"	21"	42"	60"
	24"	48"	

*Includes 5" casters.

Ships in  1



Visit the Camshelving® website at www.cambro.com/camshelving for product information, assembly videos and design layouts, or to view or download the Camshelving Specification and Price List.

ELEMENTS
SERIES

V4

4-SHELF VENTED UNITS

64"
HEIGHT

Starter units include 2 factory assembled stationary post kits, stationary traverses, stationary traverse dovetails and shelf plates. Add-On units include 1 factory assembled stationary post kit, stationary traverses, stationary traverse dovetails and shelf plates. Units ship complete in 1 box.

Starter

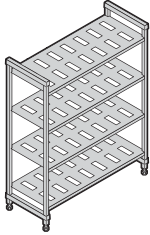

Add-On

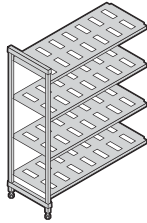

18"
DEPTH

DIMENSIONS D x L x H	CODE	LIST PRICE EA.
18" x 24" x 64"	ESU182464V4	\$ 404.90
18" x 30" x 64"	ESU183064V4	417.50
18" x 36" x 64"	ESU183664V4	458.90
18" x 42" x 64"	ESU184264V4	515.30
18" x 48" x 64"	ESU184864V4	535.50
18" x 54" x 64"	ESU185464V4	591.50
18" x 60" x 64"	ESU186064V4	629.90
18" x 72" x 64"	ESU187264V4	704.90

CODE	LIST PRICE EA.
ESU182464V4	\$ 404.90
ESU183064V4	417.50
ESU183664V4	458.90
ESU184264V4	515.30
ESU184864V4	535.50
ESU185464V4	591.50
ESU186064V4	629.90
ESU187264V4	704.90

CODE	LIST PRICE EA.
EA182464V4	\$ 320.75
EA183064V4	333.35
EA183664V4	374.75
EA184264V4	431.15
EA184864V4	451.35
EA185464V4	507.35
EA186064V4	545.75
EA187264V4	620.75

21"
DEPTH

21" x 24" x 64"	ESU212464V4	\$ 437.00
21" x 30" x 64"	ESU213064V4	453.00
21" x 36" x 64"	ESU213664V4	501.00
21" x 42" x 64"	ESU214264V4	564.60
21" x 48" x 64"	ESU214864V4	589.00
21" x 54" x 64"	ESU215464V4	652.80
21" x 60" x 64"	ESU216064V4	696.60
21" x 72" x 64"	ESU217264V4	783.80

ESU212464V4	\$ 437.00
ESU213064V4	453.00
ESU213664V4	501.00
ESU214264V4	564.60
ESU214864V4	589.00
ESU215464V4	652.80
ESU216064V4	696.60
ESU217264V4	783.80

EA212464V4	\$ 350.70
EA213064V4	366.70
EA213664V4	414.70
EA214264V4	478.30
EA214864V4	502.70
EA215464V4	566.50
EA216064V4	610.30
EA217264V4	697.50

24"
DEPTH

24" x 24" x 64"	ESU242464V4	\$ 448.00
24" x 30" x 64"	ESU243064V4	472.80
24" x 36" x 64"	ESU243664V4	514.60
24" x 42" x 64"	ESU244264V4	571.60
24" x 48" x 64"	ESU244864V4	609.00
24" x 54" x 64"	ESU245464V4	662.20
24" x 60" x 64"	ESU246064V4	701.80
24" x 72" x 64"	ESU247264V4	795.40

ESU242464V4	\$ 448.00
ESU243064V4	472.80
ESU243664V4	514.60
ESU244264V4	571.60
ESU244864V4	609.00
ESU245464V4	662.20
ESU246064V4	701.80
ESU247264V4	795.40

EA242464V4	\$ 361.00
EA243064V4	385.80
EA243664V4	427.60
EA244264V4	484.60
EA244864V4	522.00
EA245464V4	575.20
EA246064V4	614.80
EA247264V4	708.40

ELEMENTS
SERIES

V4

4-SHELF VENTED UNITS

72"
HEIGHT

Starter units include 2 factory assembled stationary post kits, stationary traverses, stationary traverse dovetails and shelf plates. Add-On units include 1 factory assembled stationary post kit, stationary traverses, stationary traverse dovetails and shelf plates. Units ship complete in 1 box.

Starter

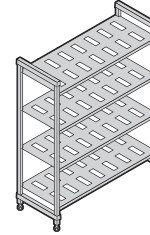

Add-On

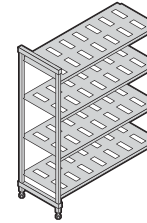

DIMENSIONS D x L x H	CODE	LIST PRICE EA.
18" x 24" x 72"	ESU182472V4	\$ 408.70
18" x 30" x 72"	ESU183072V4	421.30
18" x 36" x 72"	ESU183672V4	462.70
18" x 42" x 72"	ESU184272V4	519.10
18" x 48" x 72"	ESU184872V4	539.30
18" x 54" x 72"	ESU185472V4	595.30
18" x 60" x 72"	ESU186072V4	633.70
18" x 72" x 72"	ESU187272V4	708.70

CODE	LIST PRICE EA.
ESU182472V4	\$ 408.70
ESU183072V4	421.30
ESU183672V4	462.70
ESU184272V4	519.10
ESU184872V4	539.30
ESU185472V4	595.30
ESU186072V4	633.70
ESU187272V4	708.70

CODE	LIST PRICE EA.
EA182472V4	\$ 322.65
EA183072V4	335.25
EA183672V4	376.65
EA184272V4	433.05
EA184872V4	453.25
EA185472V4	509.25
EA186072V4	547.65
EA187272V4	622.65

21" x 24" x 72"	ESU212472V4	\$ 440.70
21" x 30" x 72"	ESU213072V4	456.70
21" x 36" x 72"	ESU213672V4	504.70
21" x 42" x 72"	ESU214272V4	568.30
21" x 48" x 72"	ESU214872V4	592.70
21" x 54" x 72"	ESU215472V4	656.50
21" x 60" x 72"	ESU216072V4	700.30
21" x 72" x 72"	ESU217272V4	787.50

ESU212472V4	\$ 440.70
ESU213072V4	456.70
ESU213672V4	504.70
ESU214272V4	568.30
ESU214872V4	592.70
ESU215472V4	656.50
ESU216072V4	700.30
ESU217272V4	787.50

EA212472V4	\$ 352.55
EA213072V4	368.55
EA213672V4	416.55
EA214272V4	480.15
EA214872V4	504.55
EA215472V4	568.35
EA216072V4	612.15
EA217272V4	699.35

24" x 24" x 72"	ESU242472V4	\$ 451.80
24" x 30" x 72"	ESU243072V4	476.60
24" x 36" x 72"	ESU243672V4	518.40
24" x 42" x 72"	ESU244272V4	575.40
24" x 48" x 72"	ESU244872V4	612.80
24" x 54" x 72"	ESU245472V4	666.00
24" x 60" x 72"	ESU246072V4	705.60
24" x 72" x 72"	ESU247272V4	799.20

ESU242472V4	\$ 451.80
ESU243072V4	476.60
ESU243672V4	518.40
ESU244272V4	575.40
ESU244872V4	612.80
ESU245472V4	666.00
ESU246072V4	705.60
ESU247272V4	799.20

EA242472V4	\$ 362.90
EA243072V4	387.70
EA243672V4	429.50
EA244272V4	486.50
EA244872V4	523.90
EA245472V4	577.10
EA246072V4	616.70
EA247272V4	710.30

Color: Brushed Graphite (580).

ELEMENTS
SERIES

84"
HEIGHT

V5
5-SHELF VENTED UNITS

Starter units include 2 factory assembled stationary post kits, stationary traverses, stationary traverse dovetails and shelf plates. Add-On units include 1 factory assembled stationary post kit, stationary traverses, stationary traverse dovetails and shelf plates. Units ship complete in 1 box.

Starter

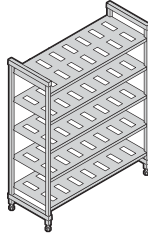

Add-On

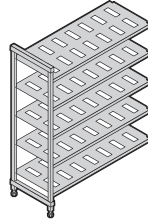

18"
DEPTH

DIMENSIONS D x L x H	CODE	LIST PRICE EA.
18" x 24" x 84"	ESU182484V5	\$ 494.65
18" x 30" x 84"	ESU183084V5	510.40
18" x 36" x 84"	ESU183684V5	562.15
18" x 42" x 84"	ESU184284V5	632.65
18" x 48" x 84"	ESU184884V5	657.90
18" x 54" x 84"	ESU185484V5	727.90
18" x 60" x 84"	ESU186084V5	775.90
18" x 72" x 84"	ESU187284V5	869.65

CODE	LIST PRICE EA.
ESU182484V5	\$ 494.65
ESU183084V5	510.40
ESU183684V5	562.15
ESU184284V5	632.65
ESU184884V5	657.90
ESU185484V5	727.90
ESU186084V5	775.90
ESU187284V5	869.65

CODE	LIST PRICE EA.
EA182484V5	\$ 395.20
EA183084V5	410.95
EA183684V5	462.70
EA184284V5	533.20
EA184884V5	558.45
EA185484V5	628.45
EA186084V5	676.45
EA187284V5	770.20

21"
DEPTH

21" x 24" x 84"	ESU212484V5	\$ 533.50
21" x 30" x 84"	ESU213084V5	553.50
21" x 36" x 84"	ESU213684V5	613.50
21" x 42" x 84"	ESU214284V5	693.00
21" x 48" x 84"	ESU214884V5	723.50
21" x 54" x 84"	ESU215484V5	803.25
21" x 60" x 84"	ESU216084V5	858.00
21" x 72" x 84"	ESU217284V5	967.00

ESU212484V5	\$ 533.50
ESU213084V5	553.50
ESU213684V5	613.50
ESU214284V5	693.00
ESU214884V5	723.50
ESU215484V5	803.25
ESU216084V5	858.00
ESU217284V5	967.00

EA212484V5	\$ 432.00
EA213084V5	452.00
EA213684V5	512.00
EA214284V5	591.50
EA214884V5	622.00
EA215484V5	701.75
EA216084V5	756.50
EA217284V5	865.50

24"
DEPTH

24" x 24" x 84"	ESU242484V5	\$ 547.00
24" x 30" x 84"	ESU243084V5	578.00
24" x 36" x 84"	ESU243684V5	630.25
24" x 42" x 84"	ESU244284V5	701.50
24" x 48" x 84"	ESU244884V5	748.25
24" x 54" x 84"	ESU245484V5	814.75
24" x 60" x 84"	ESU246084V5	864.25
24" x 72" x 84"	ESU247284V5	981.25

ESU242484V5	\$ 547.00
ESU243084V5	578.00
ESU243684V5	630.25
ESU244284V5	701.50
ESU244884V5	748.25
ESU245484V5	814.75
ESU246084V5	864.25
ESU247284V5	981.25

EA242484V5	\$ 444.75
EA243084V5	475.75
EA243684V5	528.00
EA244284V5	599.25
EA244884V5	646.00
EA245484V5	712.50
EA246084V5	762.00
EA247284V5	879.00

Color: Brushed Graphite (580).

ELEMENTS
SERIES

V4
**4-SHELF VENTED
MOBILE UNITS**

Mobile units include 2 factory assembled mobile post kits, mobile traverses, mobile traverse dovetails, shelf plates, and 4 premium swivel casters with total locking brake. Units ship complete in 1 box.

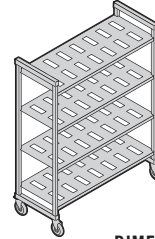

70"
HEIGHT

18"
DEPTH

CODE	DIMENSIONS D x L x H*	LIST PRICE EA.
EMU183670V4	18" x 36" x 70"	\$ 719.30
EMU184270V4	18" x 42" x 70"	775.50
EMU184870V4	18" x 48" x 70"	795.90
EMU185470V4	18" x 54" x 70"	830.90
EMU186070V4	18" x 60" x 70"	869.50

21"
DEPTH

EMU213670V4	21" x 36" x 70"	\$ 761.20
EMU214270V4	21" x 42" x 70"	825.00
EMU214870V4	21" x 48" x 70"	849.40
EMU215470V4	21" x 54" x 70"	892.40
EMU216070V4	21" x 60" x 70"	936.00

24"
DEPTH

EMU243670V4	24" x 36" x 70"	\$ 775.00
EMU244270V4	24" x 42" x 70"	831.80
EMU244870V4	24" x 48" x 70"	869.20
EMU245470V4	24" x 54" x 70"	901.80
EMU246070V4	24" x 60" x 70"	941.40

78"
HEIGHT

18"
DEPTH

CODE	DIMENSIONS D x L x H*	LIST PRICE EA.
EMU183678V4	18" x 36" x 78"	\$ 723.10
EMU184278V4	18" x 42" x 78"	779.30
EMU184878V4	18" x 48" x 78"	799.70
EMU185478V4	18" x 54" x 78"	834.70
EMU186078V4	18" x 60" x 78"	873.30

21"
DEPTH

EMU213678V4	21" x 36" x 78"	\$ 764.80
EMU214278V4	21" x 42" x 78"	828.60
EMU214878V4	21" x 48" x 78"	853.00
EMU215478V4	21" x 54" x 78"	896.00
EMU216078V4	21" x 60" x 78"	939.60

24"
DEPTH

EMU243678V4	24" x 36" x 78"	\$ 778.80
EMU244278V4	24" x 42" x 78"	835.60
EMU244878V4	24" x 48" x 78"	873.00
EMU245478V4	24" x 54" x 78"	905.60
EMU246078V4	24" x 60" x 78"	945.20

*Includes 5" casters.



CAMSHELVING® ELEMENTS SERIES ACCESSORIES

Bottom Shelf Dunnage Stands

Increase weight bearing capacity on bottom shelf only. Add to any shelf length. Highly recommended for starter units 54" and longer and all corner units, intermediate units and units specified for heavier load volume on and off bottom shelves.



CODE	DIMENSIONS D x H	LIST PRICE EA.
Dunnage Stand – Low		
EDS14H6	14" x 6½"	\$ 51.25
EDS18H6	18" x 6½"	52.90
EDS21H6	21" x 6½"	54.30
EDS24H6	24" x 6½"	55.60
Dunnage Stand – Tall		
EDS14H10	14" x 10½"	55.90
EDS18H10	18" x 10½"	57.55
EDS21H10	21" x 10½"	58.95
EDS24H10	24" x 10½"	60.25

Case Pack: 1 Color: Brushed Graphite (580).

Corner Connectors

Unique patented design ensures maximum shelf space utilization. Use 1 set per shelf to connect starter and add-on units in corners. Connect 4 or 5 intermediate shelves between 2 starter units (2 sets required per shelf). Available as a single set or 8 or 10 set packs.

CODE	DESCRIPTION	LIST PRICE EA.
ECC1	1 Set for 1 shelf	\$ 5.80
ECC8	8 Sets for 4 shelves	46.40
ECC10	10 Sets for 5 shelves	58.00

Color: Brushed Graphite (580).

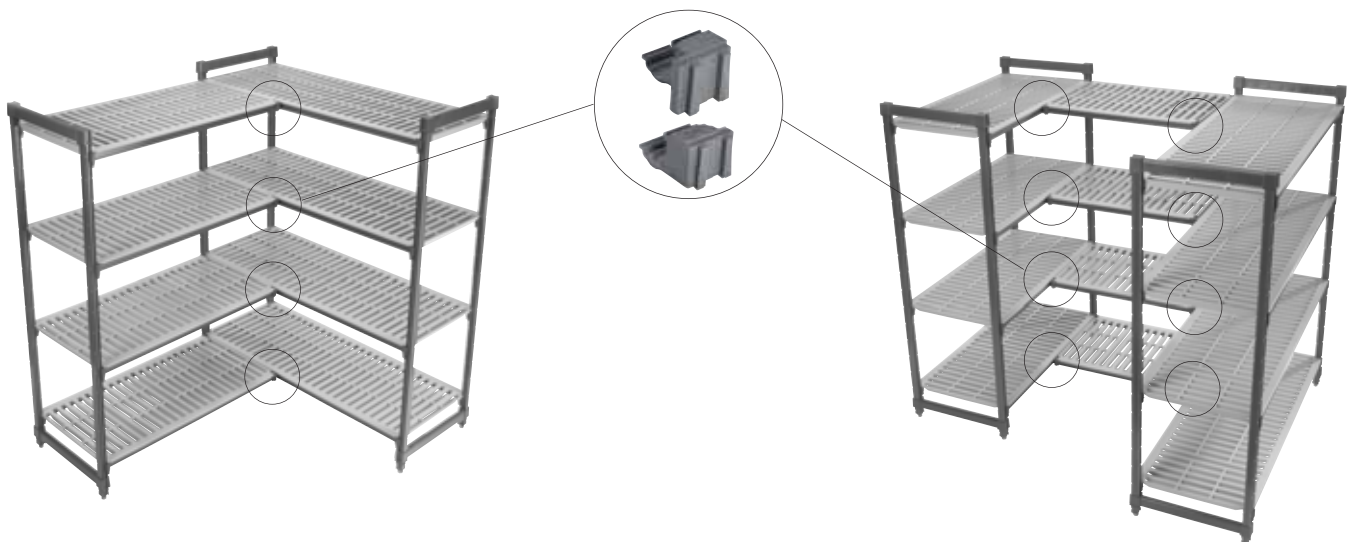

CAMSHELVING® ELEMENTS SERIES ACCESSORIES

Identification Tags

Clip onto shelf traverses to clearly identify stored product. Made of highly durable plastic with a clear slide in front panel. Labels included.

CODE	DESCRIPTION	SIZE L x H	LIST PRICE EA.
CSID6	6" ID Tag	6" x 1"	\$ 2.25
CSID3	3" ID Tag	3" x 1"	2.25

Case Pack: 12 Color: White / Clear.



Wall Fastener

Use to secure stationary shelving unit to a wall for added safety and stability where required. Made of stainless steel. Screws not included.

CODE	DIMENSION D x L x H	LIST PRICE EA.
CSWF	2 $\frac{7}{8}$ " x 9 $\frac{3}{8}$ " x 1 $\frac{1}{8}$ "	\$ 25.00

Case Pack: 4 Color: Silver (000).



*Hole diameter 7/16".



Seismic Foot

Secure stationary unit posts directly to the floor for added safety and stability where required. Made of stainless steel. Bolts not included.

CODE	DIMENSION D x L x H	LIST PRICE EA.
CSEQ3	4" x 3 $\frac{1}{3}$ " x 2 $\frac{5}{16}$ "	\$ 33.00

Case Pack: 4 Color: Silver (000).



*Hole diameter 9/16".



Premium Caster

Ideal in all areas of storage, especially coolers, freezers and/or wet areas. Made of highly durable, non-corrosive plastic with a 5" swivel, non-marking thermoplastic rubber wheel. Total locking brake locks both swivel motion and the wheel.

CODE	SIZE	LIST PRICE EA.
EMCWB	5"	\$ 56.65

Case Pack: 2 Color: Gray (000).



Donut Bumper

Offers added protection during transport and when maneuvering mobile units into place against walls or alongside other units for storage.

CODE	DIAMETER	LIST PRICE EA.
CSMHDB	5"	\$ 10.70

Case Pack: 4 Color: Gray (000).

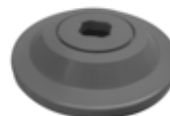

CAMSHELVING® ELEMENTS SERIES ACCESSORIES

Shelf Rails

Brackets are quick and easy to install and remove. Fits shelving units 24" to 72" wide and 14" to 24" deep. Double rods provide maximum security for shelf contents.

New rails can be used with shelf dividers and drying racks. Available in kits of 3 or 4 sides to meet all foodservice needs.

Full Shelf Rail Kits

CODE	DIMENSION D x L	LIST PRICE EA.
Full Shelf Rail Kits (2 sides, 2 ends)		
ESR2436	24" x 36"	\$ 121.40
ESR2442	24" x 42"	129.30
ESR2448	24" x 48"	135.20
3/4 Shelf Rail Kits (1 side, 2 ends)		
ESR24363	24" x 36"	86.90
ESR24423	24" x 42"	90.85
ESR24483	24" x 48"	93.80

Case Pack: 1 **Color:** Soft Gray (151).

Shelf Rail kits are available in all depths and all lengths. To see the entire selection of Full & 3/4 kits, see the Camshelving Product Specification and Price List.

Single Side Rail Kits

CODE	LENGTH	LIST PRICE EA.
ESR24S	24"	\$ 28.70
ESR30S	30"	31.55
ESR36S	36"	34.50
ESR42S	42"	38.45
ESR48S	48"	41.40
ESR54S	54"	45.30
ESR60S	60"	48.20
ESR72S	72"	55.10

Single End Rail Kits

CODE	DEPTH	LIST PRICE EA.
ESR14E	14"	\$ 21.75
ESR18E	18"	23.50
ESR21E	21"	24.80
ESR24E	24"	26.20

New!



Shelf Divider

Stack and separate items stored on shelves. Made of highly durable ABS plastic. Installs directly onto solid or vented shelves. Easily removable for relocating or washing. Use with Shelf Rails to prevent contents from falling off shelves.

CODE	DIMENSION D x H	LIST PRICE EA.
CSSD188	18" x 8"	\$ 17.00
CSSD218	21" x 8"	18.50
CSSD248	24" x 8"	20.00

Case Pack: 1
Color: Soft Gray (151).



Shelf Divider Bars (for 24" deep shelf only)

Create a custom service or storage station for food pans, boxes or dish racks. Install straight or angled dividers directly onto shelf traverses.

CODE	DESCRIPTION	LIST PRICE EA.
EDBA	Angled Divider Bar	\$ 4.40
EDBS	Straight Divider Bar	4.40

Case Pack: 4
Color: Speckled Gray (480).

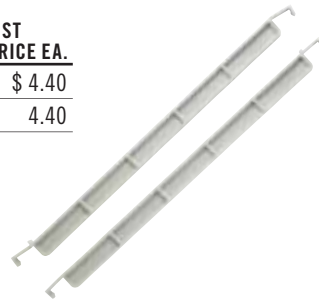

Single Shelf Sheet Pan / Tray Rack (for 24" deep shelf only)

Holds up to 6 each full size (1826) or 12 half size (1318) sheet pans or trays. Install 1 or more units onto vented shelves, any length. High quality, lightweight aluminum material is safe for use in coolers and freezers. Made from aluminum 6463 (6000 series).

CODE	DIMENSION D x L x H	LIST PRICE EA.
CSTSR	23" x 20 3/8" x 20"	\$ 385.00

Case Pack: 1 **Color:** Silver (000).



CAMSHELVING® ELEMENTS SERIES ACCESSORIES

Single Shelf Security Cage (for 24" deep shelf only)

Securely store valuable products on a single shelf. Made of heavy duty, 304 stainless steel for use in any environment. Requires 18" height between shelves. Install on vented shelves only. Lock not included.

CODE	DIMENSION D x L x H	LIST PRICE EA.
CSSC244818	25¼" x 42½" x 18"	\$ 640.00
Case Pack: 1 Color: Silver (000).		



Shelf Traverses

Available in single or double packs, stationary or mobile. Use two traverses to add an open shelf for divider bars or drying cradles. Add one stationary traverse onto back posts of a stationary unit for extra support when placing rolling equipment under the first shelf. Traverse dovetails included.

Stationary

LENGTH	SINGLE PACK CODE*	LIST PRICE EA.	DOUBLE PACK CODE**	LIST PRICE EA.
24"	ETR24	\$ 24.90	—	—
30"	ETR30	27.00	—	—
36"	ETR36	28.05	ETR362PK	\$ 56.10
42"	ETR42	29.95	ETR422PK	59.90
48"	ETR48	32.65	ETR482PK	65.30
54"	ETR54	35.45	ETR542PK	70.90
60"	ETR60	38.20	ETR602PK	76.40
72"	ETR72	43.70	—	—

*Case Pack: 1 **Case Pack: 2
Color: Brushed Graphite (580).



Stationary
Traverse

Mobile

LENGTH	SINGLE PACK CODE*	LIST PRICE EA.	DOUBLE PACK CODE**	LIST PRICE EA.
36"	EMTR36	\$ 33.50	EMTR362PK	\$ 67.00
42"	EMTR42	36.30	EMTR422PK	72.60
48"	EMTR48	39.10	EMTR482PK	78.20
54"	EMTR54	41.85	EMTR542PK	83.70
60"	EMTR60	44.65	EMTR602PK	89.30

*Case Pack: 1 **Case Pack: 2
Color: Brushed Graphite (580).



Mobile
Traverse

Dome Drying and Storage Cradle (for 21" deep shelf only)

Use to dry and safely store up to 10 patient meal delivery domes or plate covers upright. Installs directly onto shelf traverses. Made of highly durable ABS plastic. Available in single or 5 pack.

CODE	DIMENSIONS D x L x H	CASE PACK	LIST PRICE EA.
CSDDC	20½" x 16⅓" x 3⅜"	1	\$ 45.00
CSDDC5	20½" x 16⅓" x 3⅜"	5	225.00
Color: Soft Gray (151).			



CAMSHELVING® ELEMENTS SERIES ACCESSORIES

Vertical Drying and Storage Cradle (for 24" deep shelf only)

Modular 7-slot rack designed for drying and storing trays, sheet pans, cutting boards and lids. Installs directly onto shelf traverses. Made of highly durable ABS plastic. Available in single or 3 pack. Use with Shelf Rails to prevent contents from sliding off.

CODE	DIMENSIONS D x L x H	CASE PACK	LIST PRICE EA.
CSDR7	23½" x 10¼" x 3¼"	1	\$ 56.00
CSDR73	23½" x 10¼" x 3¼"	3	168.00

Color: Soft Gray (151).



Vertical Drying and Storage Rack

Promotes sanitary drying, safe handling and efficient product organization with easy access to product. Use with Shelf Rails to prevent contents from sliding off.

Units ship complete with factory assembled mobile post kits, 6 mobile shelf traverses, mobile shelf traverse dovetails, 12 or 15 vertical drying cradles and premium swivel casters with total locking brake. Assembly required.

CODE	DIMENSIONS D x L x H	HOLDING CAPACITY	LIST PRICE EA.
EMU244878DRPKG	24" x 48" x 78"	84 trays	\$ 1,273.90
EMU246078DRPKG	24" x 60" x 78"	105 trays	1,441.90

Color: Brushed Graphite (580).

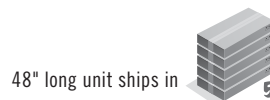

48" long unit ships in

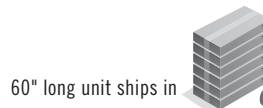

60" long unit ships in



Angled Drying and Storage Cradle (for 24" deep shelf only)

Uniquely designed cradle holds up to 8 each meal delivery pellets or use to dry, store and transport food pans and other commercial kitchen ware. Installs directly onto shelf traverses. Made of highly durable ABS plastic. Available in single or 4 pack.

CODE	DIMENSIONS D x L x H	CASE PACK	LIST PRICE EA.
CSDR8	23⅞" x 10⅝" x 6⅞"	1	\$ 45.00
CSDR84	23⅞" x 10⅝" x 6⅞"	4	180.00

Color: Soft Gray (151).



Angled Drying and Storage Rack

Promotes sanitary drying, safe handling and efficient product organization with easy access to product.

Unit ships complete with factory assembled mobile post kits, 8 mobile shelf traverses, mobile shelf traverse dovetails, 16 angled drying cradles and premium swivel casters with total locking brake. Assembly required.

CODE	DIMENSIONS D x L x H	HOLDING CAPACITY	LIST PRICE EA.
EMU244878PDPKG	24" x 48" x 78"	128 Pellets and Bases or 16 GN 1/1 Food Pans	\$ 1,443.60

Color: Brushed Graphite (580).



Ships in



CAMSHELVING® **BASICS PLUS** series

WHY CHOOSE BASICS PLUS?

Just because the budget is tight and storage needs are less rigorous, it doesn't mean that shelving performance and storage efficiencies should be compromised. Basics Plus Series is made from the same high performing, strong composite material as Elements Series and has the same design features. It's lighter in weight and less in cost but still strong enough to handle light to medium storage demands.



All Environments
-36°F TO 190°F

Stationary



COMPONENT

Post Connectors, Corner Connectors, Seismic Foot, Wall Fastener, and Identification Tags are not NSF listed.

storage needs
LIGHT to MEDIUM

weekly deliveries

2 – 5

CAMSHELVING® BASICS PLUS SERIES STATIONARY UNIT SIZES

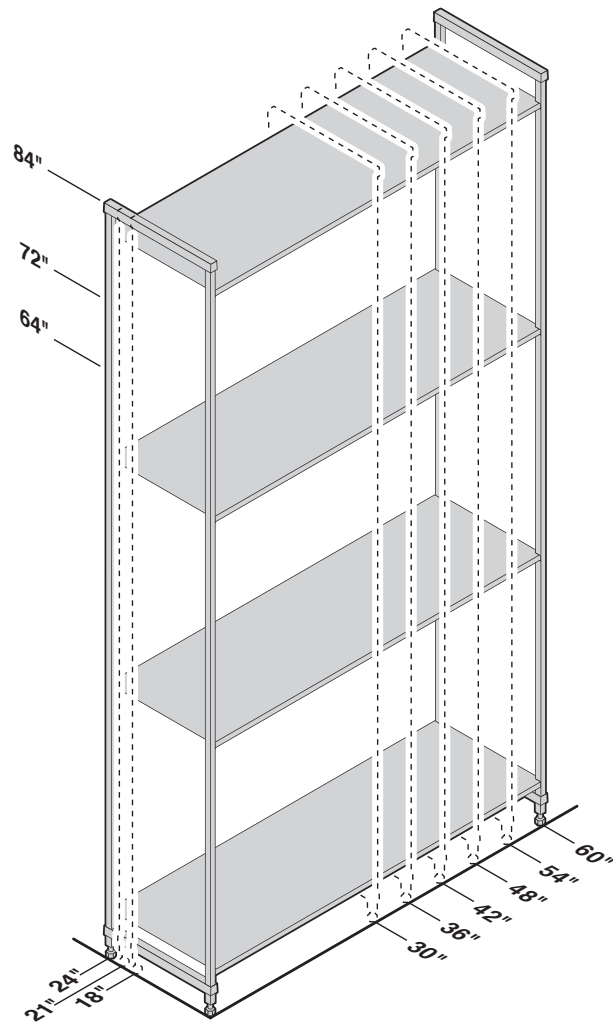

BASICS PLUS SERIES WEIGHT BEARING CAPACITY

Weight must be evenly distributed across the entire shelf.

		UNIT LENGTH 30" – 48"	UNIT LENGTH 54" – 60"
SINGLE UNIT	Unit only	1800 lbs.	1800 lbs.
	Shelf only	700	500
	Unit with dunnage stand*	2100	2100
	Bottom shelf with dunnage stand*	1000	800
CORNER UNIT With 2 Dunnage Stands required	Unit only	1350	—
	Shelf only	300	—
	Bottom shelf with dunnage stands*	450	—

*Dunnage Stands add stability and increase weight bearing capacity on bottom shelf only. Highly recommended for Starter Units 54" and longer, all Corner Units, U-Shape Units and units specified for heavier loads. (See page 98).

CAMSHELVING® BASICS PLUS SERIES

Starter and Add-On Units

These units make ordering easy and save time and labor during installation. Units ship complete in one box. Post kits are pre-assembled at the factory, speeding up on site set up.



4-Shelf Vented Stationary Starter and Add-On Units

Starter units include 2 factory assembled post kits and shelves.

Add-On units include 1 factory assembled post kit and shelves.

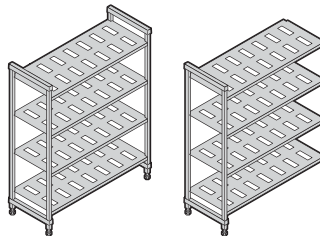

HEIGHTS	DEPTHS	LENGTHS	
3	3	6	
64"	18"	30"	48"
72"	21"	36"	54"
84"	24"	42"	60"

Ships in  1

4-Shelf Solid Stationary Starter and Add-On Units

Starter units include 2 factory assembled post kits and shelves.

Add-On units include 1 factory assembled post kit and shelves.

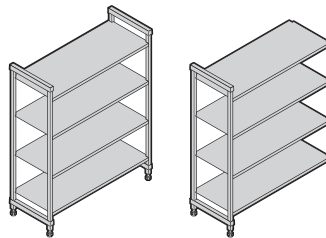

HEIGHTS	DEPTHS	LENGTHS	
3	3	6	
64"	18"	30"	48"
72"	21"	36"	54"
84"	24"	42"	60"

Ships in  1

4-Shelf Vented and Solid Stationary Starter and Add-On Units (3 vented + 1 solid)

Starter units include 2 factory assembled post kits and shelves.

Add-On units include 1 factory assembled post kit and shelves.

Install solid shelf on bottom to prevent water/cleaning solutions from sloshing up onto stored products. Install solid shelf on top to protect product stored on lower shelves from condensation in cooler.

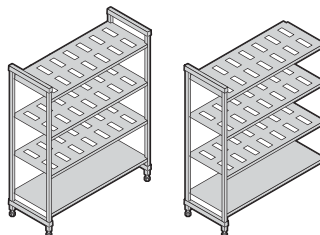

HEIGHTS	DEPTHS	LENGTHS	
3	3	6	
64"	18"	30"	48"
72"	21"	36"	54"
84"	24"	42"	60"

Ships in  1

5-Shelf Vented Stationary Starter and Add-On Units

Starter units include 2 factory assembled post kits and shelves.

Add-On units include 1 factory assembled post kit and shelves.

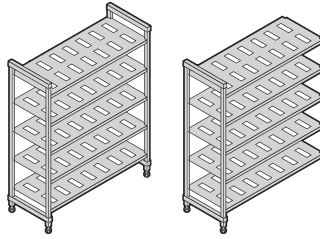

HEIGHTS	DEPTHS	LENGTHS	
3	3	6	
64"	18"	30"	48"
72"	21"	36"	54"
84"	24"	42"	60"

Ships in



5-Shelf Solid Stationary Starter and Add-On Units

Starter units include 2 factory assembled post kits and shelves.

Add-On units include 1 factory assembled post kit and shelves.

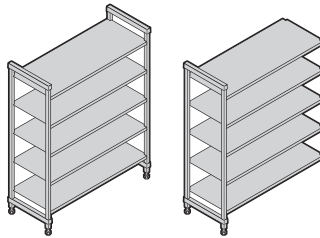

HEIGHT	DEPTHS	LENGTHS	
1	3	6	
84"	18"	30"	48"
	21"	36"	54"
	24"	42"	60"

Ships in



5-Shelf Vented and Solid Stationary Starter And Add-On Units (4 vented + 1 solid)

Starter units include 2 factory assembled post kits and shelves.

Add-On units include 1 factory assembled post kit and shelves.

Install solid shelf on bottom to prevent water/cleaning solutions from sloshing up onto stored products. Install solid shelf on top to protect product stored on lower shelves from condensation in cooler.

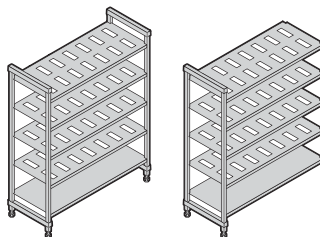

HEIGHT	DEPTHS	LENGTHS	
1	3	6	
84"	18"	30"	48"
	21"	36"	54"
	24"	42"	60"

Ships in



Visit the Camshelving® website at www.cambro.com/camshelving for product information, assembly videos and design layouts, or to view or download the Camshelving Specification and Price List.

BASICS PLUS SERIES
64"
HEIGHT

V4
4-SHELF VENTED UNITS

Starter units include 2 factory assembled post kits and shelves. Add-on units include 1 factory assembled post kit and shelves. Units ship complete in 1 box.

Starter

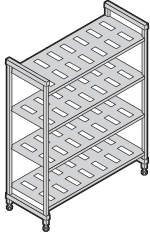

Add-On

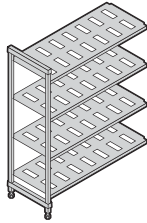

18"
DEPTH

DIMENSIONS D x L x H	CODE	LIST PRICE EA.	CODE	LIST PRICE EA.
18" x 30" x 64"	CBU183064V4	\$ 334.30	CBA183064V4	\$ 266.95
18" x 36" x 64"	CBU183664V4	367.10	CBA183664V4	299.75
18" x 42" x 64"	CBU184264V4	412.30	CBA184264V4	344.95
18" x 48" x 64"	CBU184864V4	428.50	CBA184864V4	361.15
18" x 54" x 64"	CBU185464V4	473.30	CBA185464V4	405.95
18" x 60" x 64"	CBU186064V4	503.90	CBA186064V4	436.55

21"
DEPTH

21" x 30" x 64"	CBU213064V4	\$ 362.30	CBA213064V4	\$ 293.25
21" x 36" x 64"	CBU213664V4	400.90	CBA213664V4	331.85
21" x 42" x 64"	CBU214264V4	451.90	CBA214264V4	382.85
21" x 48" x 64"	CBU214864V4	471.10	CBA214864V4	402.05
21" x 54" x 64"	CBU215464V4	522.50	CBA215464V4	453.45
21" x 60" x 64"	CBU216064V4	557.30	CBA216064V4	488.25

24"
DEPTH

24" x 30" x 64"	CBU243064V4	\$ 378.20	CBA243064V4	\$ 308.60
24" x 36" x 64"	CBU243664V4	411.80	CBA243664V4	342.20
24" x 42" x 64"	CBU244264V4	457.20	CBA244264V4	387.60
24" x 48" x 64"	CBU244864V4	487.20	CBA244864V4	417.60
24" x 54" x 64"	CBU245464V4	529.80	CBA245464V4	460.20
24" x 60" x 64"	CBU246064V4	561.40	CBA246064V4	491.80

Color: Brushed Graphite (580).

BASICS PLUS SERIES
72"
HEIGHT

V4
4-SHELF VENTED UNITS

Starter units include 2 factory assembled post kits and shelves. Add-on units include 1 factory assembled post kit and shelves. Units ship complete in 1 box.

Starter

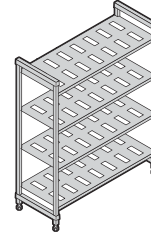

Add-On

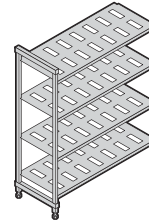

DIMENSIONS D x L x H	CODE	LIST PRICE EA.	CODE	LIST PRICE EA.
18" x 30" x 72"	CBU183072V4	\$ 337.30	CBA183072V4	\$ 268.45
18" x 36" x 72"	CBU183672V4	370.10	CBA183672V4	301.25
18" x 42" x 72"	CBU184272V4	415.30	CBA184272V4	346.45
18" x 48" x 72"	CBU184872V4	431.50	CBA184872V4	362.65
18" x 54" x 72"	CBU185472V4	476.30	CBA185472V4	407.45
18" x 60" x 72"	CBU186072V4	506.90	CBA186072V4	438.05

21" x 30" x 72"	CBU213072V4	\$ 365.20	CBA213072V4	\$ 294.70
21" x 36" x 72"	CBU213672V4	403.80	CBA213672V4	333.30
21" x 42" x 72"	CBU214272V4	454.80	CBA214272V4	384.30
21" x 48" x 72"	CBU214872V4	474.00	CBA214872V4	403.50
21" x 54" x 72"	CBU215472V4	525.40	CBA215472V4	454.90
21" x 60" x 72"	CBU216072V4	560.20	CBA216072V4	489.70

24" x 30" x 72"	CBU243072V4	\$ 381.20	CBA243072V4	\$ 310.10
24" x 36" x 72"	CBU243672V4	414.80	CBA243672V4	343.70
24" x 42" x 72"	CBU244272V4	460.20	CBA244272V4	389.10
24" x 48" x 72"	CBU244872V4	490.20	CBA244872V4	419.10
24" x 54" x 72"	CBU245472V4	532.80	CBA245472V4	461.70
24" x 60" x 72"	CBU246072V4	564.40	CBA246072V4	493.30

BASICS PLUS SERIES
84"
HEIGHT

V5
5-SHELF VENTED UNITS

Starter units include 2 factory assembled post kits and shelves. Add on units include 1 factory assembled post kit and shelves. Units ship complete in 1 box.

Starter

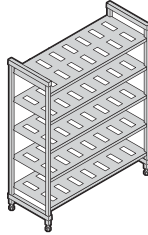

Add-On

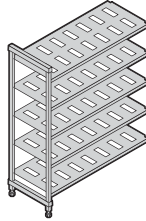

18"
DEPTH

DIMENSIONS D x L x H	CODE	LIST PRICE EA.	CODE	LIST PRICE EA.
18" x 30" x 84"	CBU183084V5	\$ 408.70	CBA183084V5	\$ 329.10
18" x 36" x 84"	CBU183684V5	449.70	CBA183684V5	370.10
18" x 42" x 84"	CBU184284V5	506.20	CBA184284V5	426.60
18" x 48" x 84"	CBU184884V5	526.45	CBA184884V5	446.85
18" x 54" x 84"	CBU185484V5	582.45	CBA185484V5	502.85
18" x 60" x 84"	CBU186084V5	620.70	CBA186084V5	541.10

21"
DEPTH

21" x 30" x 84"	CBU213084V5	\$ 442.65	CBA213084V5	\$ 361.45
21" x 36" x 84"	CBU213684V5	490.90	CBA213684V5	409.70
21" x 42" x 84"	CBU214284V5	554.65	CBA214284V5	473.45
21" x 48" x 84"	CBU214884V5	578.65	CBA214884V5	497.45
21" x 54" x 84"	CBU215484V5	642.90	CBA215484V5	561.70
21" x 60" x 84"	CBU216084V5	686.40	CBA216084V5	605.20

24"
DEPTH

24" x 30" x 84"	CBU243084V5	\$ 462.35	CBA243084V5	\$ 380.55
24" x 36" x 84"	CBU243684V5	504.35	CBA243684V5	422.55
24" x 42" x 84"	CBU244284V5	561.10	CBA244284V5	479.30
24" x 48" x 84"	CBU244884V5	598.60	CBA244884V5	516.80
24" x 54" x 84"	CBU245484V5	651.85	CBA245484V5	570.05
24" x 60" x 84"	CBU246084V5	691.35	CBA246084V5	609.55

Color: Brushed Graphite (580).

1.800.833.3003





CAMSHELVING® BASICS PLUS SERIES ACCESSORIES

Bottom Shelf Dunnage Stands

Increase weight bearing capacity on bottom shelf only. Add to any shelf length. Highly recommended for starter units 54" and longer and all corner units, intermediate units and units specified for heavier load volume on and off bottom shelves.



CODE	DIMENSIONS D x H	LIST PRICE EA.
Dunnage Stand – Low		
CBDS18H6	18" x 6¾"	\$ 50.25
CBDS21H6	21" x 6¾"	51.60
CBDS24H6	24" x 6¾"	52.80
Dunnage Stand – Tall		
CBDS18H10	18" x 10¾"	50.45
CBDS21H10	21" x 10¾"	51.80
CBDS24H10	24" x 10¾"	53.00

Case Pack: 1 Color: Brushed Graphite (580).

Shelf Traverses

Add one traverse onto back posts for extra support when placing rolling equipment under the first shelf. Traverse dovetails included.



CODE	LENGTH	LIST PRICE EA.
CBTR30	30"	\$ 24.50
CBTR36	36"	24.70
CBTR42	42"	27.40
CBTR48	48"	30.00
CBTR54	54"	32.65
CBTR60	60"	35.20

Case Pack: 1 Color: Brushed Graphite (580).

CAMSHELVING® BASICS PLUS SERIES ACCESSORIES

Corner Connectors

Unique patented design ensures maximum shelf space utilization. Use 1 set per shelf to connect starter and add-on units in corners. Connect 4 or 5 intermediate shelves between 2 starter units (2 sets required per shelf). Available as a single set or 8 or 10 set packs.

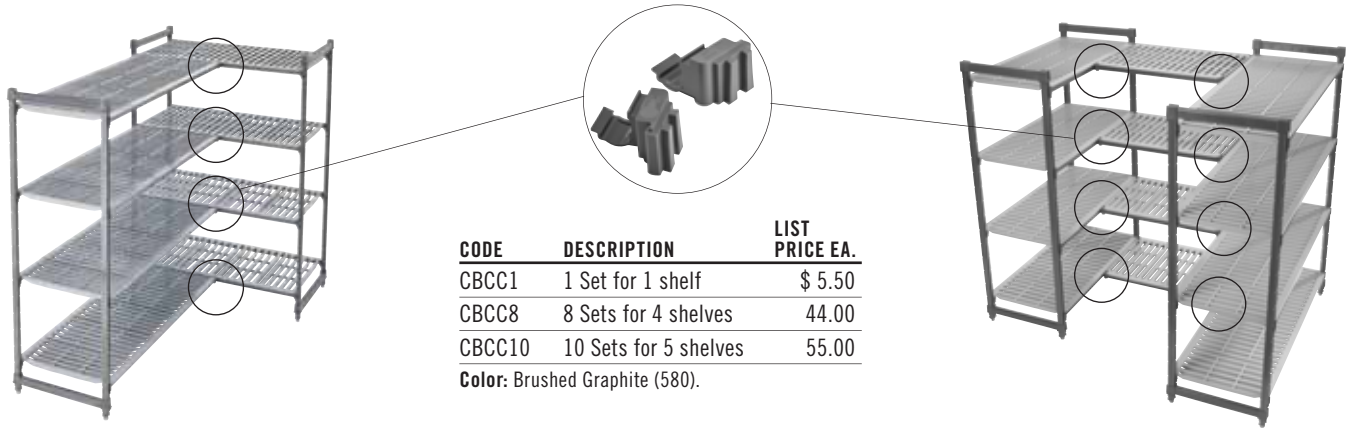

CODE	DESCRIPTION	LIST PRICE EA.
CBCC1	1 Set for 1 shelf	\$ 5.50
CBCC8	8 Sets for 4 shelves	44.00
CBCC10	10 Sets for 5 shelves	55.00

Color: Brushed Graphite (580).

Identification Tag

Clip onto shelf traverses to clearly identify stored product. Made of highly durable plastic with a clear slide in front panel. Labels included.

CODE	DESCRIPTION	DIMENSION L x H	LIST PRICE EA.
CBID6	6" ID tag	6" x 1"	\$ 2.80

Case Pack: 12 **Color:** White / Clear.



Wall Fastener

Use to secure stationary shelving unit to a wall for added safety and stability where required. Made of stainless steel. Screws not included.

CODE	DIMENSION D x L x H	LIST PRICE EA.
CSWF	2 $\frac{7}{8}$ " x 9 $\frac{3}{8}$ " x 1 $\frac{1}{8}$ "	\$ 25.00

Case Pack: 4 **Color:** Silver (000).

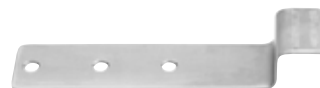

*Hole diameter 7/16".



Seismic Foot

Secure stationary unit posts directly to the floor for added safety and stability where required. Made of stainless steel. Bolts not included.

CODE	DIMENSION D x L x H	LIST PRICE EA.
CSEQ3	4" x 3 $\frac{1}{3}$ " x 2 $\frac{1}{16}$ "	\$ 33.00

Case Pack: 4 **Color:** Silver (000).



*Hole diameter 9/16".



CAMSHELVING® WALL SHELVES AND SHELF EXTENDERS

Wall Shelves

- Expand storage space in kitchens, above work stations and sinks.
- Features virtually indestructible I-beam supports that hold up to 150 lbs. (68 kg) per shelf.
- Durable polypropylene withstands temperatures up to 190°F (88°C), and will not rust or corrode.

- Snap fit rail design allows shelves to snap on and off for easy cleaning.
- 2" (5 cm) backsplash and marine front edge controls spills and cross contamination.

Shelf Extenders

- Convert empty wall space into a functional storage area.
- Use with or without Camshelving Wall Shelves.
- Peg strips withstand temperatures up to 190°F (88°C), and will not rust or corrode.

Wall Shelf Color: Speckled Gray (480).

Extender Peg Strip Color: Black (110).



Shelf Extenders ship in one carton with all hardware and includes:

LENGTH	PEG STRIPS	BRACKETS	HOOKS
36"	3	2	6
48"	3	3	9

Wall Shelves 14" Depth



CODE	CSWS1436SK	CSWS1448SK	CSWS1436VK	CSWS1448VK
DESCRIPTION	36" x 14" wall shelf, solid	48" x 14" wall shelf, solid	36" x 14" wall shelf, vented	48" x 14" wall shelf, vented
EXTERIOR DIMENSIONS	L 36" x D 14" x H 13½"	L 48" x D 14" x H 13½"	L 36" x D 14" x H 13½"	L 48" x D 14" x H 13½"
LIST PRICE EACH	\$ 152.40	\$ 175.00	\$ 152.40	\$ 175.00

Case Pack: 1

Wall Shelves 18" Depth



CODE	CSWS1836SK	CSWS1848SK	CSWS36EK	CSWS48EK
DESCRIPTION	36" x 18" wall shelf, solid	48" x 18" wall shelf, solid	36" shelf extender	48" shelf extender
EXTERIOR DIMENSIONS	L 36" x D 18" x H 13½"	L 48" x D 18" x H 13½"	L 35½" x D 2" x H 15½"	L 47½" x D 2" x H 15½"
LIST PRICE EACH	\$ 175.00	\$ 191.90	\$ 211.15	\$ 314.15

Case Pack: 1

Shelf Extenders

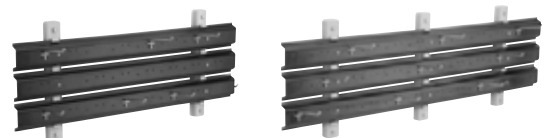

DUNNAGE RACKS



S-Series Dunnage Racks

- Keep frozen, cold or dry inventory 12" (30,5 cm) safely off the floor.
- One piece construction and sturdy legs provide strength and stability.
- Heavy duty polypropylene is safe to -36°F (-38°C), and will not rust, corrode or bend.
- Choose slotted tops for maximum air circulation around perishable products.
- Solid tops catch spills for easy clean up.

Colors: Dark Brown (131),
Speckled Gray (480).



CODE	EXTERIOR DIMENSIONS L x D x H	LOAD CAPACITY	LIST PRICE EA.
Solid Top			
DRS30	30" x 21" x 12"	1500 lbs.	\$ 235.00
DRS36	36" x 21" x 12"	1500	255.00
DRS48	48" x 21" x 12"	3000	305.00
DRS60	60" x 21" x 12"	3000	350.00
Slotted Top			
DRS300	30" x 21" x 12"	1500	235.00
DRS360	36" x 21" x 12"	1500	255.00
DRS480	48" x 21" x 12"	3000	305.00
DRS600	60" x 21" x 12"	3000	350.00

Case Pack: 1 InStock Color: Speckled Gray (480).

Camlink®

Camlink connectors securely lock dunnage racks together for greater stability.



CODE	CASE PACK	LIST PRICE EA.
DRLNK	6	\$ 2.40

Color: Black (110).

Camlink fits all sizes and styles.
One free Camlink supplied with every
Dunnage Rack.





supplies

- STORAGE
- TABLE SERVICE
- DISPLAY
- TRAYS



STORAGE

Quick Guide To Storage Solutions

Camwear® CamSquare®
Food Storage Containers

Camwear Round Food Storage Containers

Camwear Food Storage Boxes

StoreSafe® Food Rotation Labels

Camwear Food Pans

Camwear Colander Pans

X-Pan® High Heat Food Pans

H-Pan™ High Heat Food Pans

H-Pan High Heat Colander Pans

High Heat H-Pan with Handle(s)

Translucent Food Pans

Translucent Colander Pans

ColdFest® Gastronorm Pans, Crocks,
Covers & Pumps

Pizza Dough Boxes

Ingredient Bins & Camcrisper®

Camwear Scoops & Measuring Cups

Allergen Management



QUICK GUIDE TO STORAGE SOLUTIONS



Storage Containers

CamSquares® Food Storage Containers

Keeps food fresh and maximizes storage areas.



7	3	2
SIZES	MATERIALS	LID TYPES

Round Food Storage Containers

Store ingredients or transport ready to serve or partially prepared foods.



8	3	4
SIZES	MATERIALS	LID TYPES

Food Storage Boxes

Safely store bulk produce, meat, poultry and seafood.



2	5	2	2
SIZES	DEPTHS	MATERIALS	LID TYPES

Coldfest®

GN Pans

Holds cold food at safe temperatures without ice for hours.



4	1	1	5
SIZES	DEPTH	MATERIAL	LID TYPES

Food Pans

Camwear® Food Pans

Store, transport and serve all in one pan. Virtually unbreakable Camwear will not crack, bend or dent. Withstands temperatures from -40° to 210°F (-40° to 99°C).



8	4	3	7
SIZES	DEPTHS	COLORS	LID TYPES

Translucent Food Pans

An economical choice for storage and serving. Ideal for use in cold and ambient environments. Withstands temperatures from -40° to 160°F (-40° to 70°C).



6	2	1	3
SIZES	DEPTHS	COLOR	LID TYPES

X-Pan® High Heat Food Pans

Pans withstand and adapt to different temperatures cold to hot, thus expanding functionality and reducing unnecessary handling. Withstands temperatures from -40° to 375°F (-40° to 190°C).



7	3	1	6
SIZES	DEPTHS	COLOR	LID TYPES

Colander Pans

Liquids drain away from food into the pan below for enhanced food quality and improved food safety.

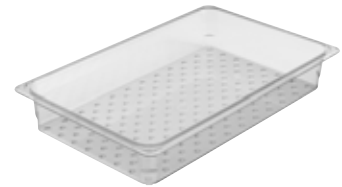

4	2	3	3
SIZES	DEPTHS	MATERIALS	LID TYPES

H-Pan™ High Heat Food Pans

Pans can go from prep to cooler to oven to steam table. Withstands temperatures from -40° to 375°F (-40° to 190°C).



8	3	2	7
SIZES	DEPTHS	COLORS	LID TYPES

Ingredient Bins

Store dry bulk ingredients such as flour and grain.



6	1	3
CAPACITIES	COLOR	LID TYPES

Food Pan Lids

Covers protect contents better than plastic wrap or foil while saving time and money. Lids improve food safety and extend product freshness. Fit selected Camwear®, X-Pan®, H-Pan™ high heat and translucent food pans.

7	7	3	5
TYPES	SIZES	MATERIALS	COLORS

Flat Cover

Basic cover available in all pan sizes.



Notched FlipLid®

FlipLid with notch to rest spoon in contents with lid closed.



Cover with Handle

Deep molded handle provides secure grip. Includes peg hole for sanitary drying.



Seal Cover for Camwear and Translucent Food Pans

Translucent seal cover provides an inner seal to protect food quality while eliminating the expense of plastic wrap.



Notched Cover with Handle

Notched cover allows utensils to remain in pan and off of potentially contaminated counters. Includes peg hole for sanitary drying.



GripLid®

Grips the side of the pan, reducing spills and points of cross contamination. Fits Camwear and high heat pans.



FlipLid®

Keeps contents covered and flips up easily for service.



Materials

Camwear®

Virtually unbreakable Camwear material will not crack, bend or dent. Withstands temperatures from -40° to 210°F (-40° to 99°C).



Polypropylene

Translucent polypropylene material provides a high chemical resistance. Withstands temperatures from -40° to 160°F (-40° to 70°C).



Polyethylene

High chemical and impact resistant material. Withstands temperatures from -40° to 160°F (-40° to 70°C).



X-Pan High Heat

Ideal for use in microwaves, steam tables, ovens and hot holding applications. Withstands temperatures from -40° to 375°F (-40° to 190°C).



H-Pan High Heat

High Heat Material is safe for heating and holding applications. Withstands temperatures from -40° to 375°F (-40° to 190°C).



ABS

High-performance and impact resistant material. Ideal for temperatures at or below 41°F (4°C).



CAMWEAR® CAMSQUARE® FOOD STORAGE CONTAINERS



Maximize your storage area with CamSquare food storage containers. The square shape provides 33% better space usage than traditional round containers. Clear Camwear provides product visibility for at a glance inventory management. Seal covers feature an inner and outer seal for superior spill resistance, even during transport.

Note: All graduations are approximate.



Tight fitting seal cover is spill resistant, saves expense & is safer for employees to handle during transport.

Interstacking saves space when not in use.



Wide molded-in handles on larger sizes ease carrying. Molded-in holes offer quick and sanitary drying.

Stain and odor resistant.

Crystal clear, virtually unbreakable Camwear withstands temperatures from -40° to 210°F (-40° to 99°C).

Easy to read color permanent graduations printed on the outside for quick inventory management.

Seal Covers for Camwear CamSquares*

- Inner and outer seal provide excellent spill resistance.
- Includes a hole on the corner for hanging during storage.
- Translucent lid easily identifies contents.
- Withstands temperatures from -40° to 160°F (-40° to 70°C).

*Seal covers only fit Camwear square containers.



CAMSQUARE® FOOD STORAGE CONTAINERS

Translucent

- Translucent material provides some content visibility and high chemical resistance.
- Withstands temperatures from -40° to 160°F (-40° to 70°C).
- Easy to read graduations are printed on the outside for at a glance inventory management.

Note: All graduations are approximate.



Poly

- Economical storage choice.
- Made of impact, stain and chemical resistant material.
- Withstands temperatures from -40° to 160°F (-40° to 70°C).

Note: All graduations are approximate.



Covers for CamSquares

- Snap-tight polyethylene covers feature thumb tabs for easy removal.
- Covers fit Camwear®, translucent and poly CamSquare containers.



Personalized Storage Products

Personalize food storage products to identify menu items, add fill lines for recipes, or use personalization in multiple languages to help ensure product quality and consistency.



CAMWEAR® CAMSQUARE® FOOD STORAGE CONTAINERS





							
CODE	2SFSCW	4SFSCW	6SFSCW	8SFSCW	12SFSCW**	18SFSCW**	22SFSCW**
CAPACITY	2 qt.	4 qt.	6 qt.	8 qt.	12 qt.	18 qt.	22 qt.
DIM. L x W x H	7¼" x 7¼" x 3½"	7¼" x 7¼" x 7½"	8¾" x 8¾" x 7¼"	8¾" x 8¾" x 9½"	11¼" x 12¼" x 8¾"	11¼" x 12¼" x 12½"	11¼" x 12¼" x 15¾"
LIST PRICE EACH	\$ 8.55	\$ 13.05	\$ 16.90	\$ 19.85	\$ 26.45	\$ 39.25	\$ 49.75

Case Pack: 6 Color/InStock Color: Clear (135). Height includes covers.



Seal Covers for Camwear CamSquares*

			
CODE	SFC2SCPP	SFC6SCPP	SFC12SCPP
DESCRIPTION	Fits 2 & 4 qt.	Fits 6 & 8 qt.	Fits 12, 18 & 22 qt.
LIST PRICE EACH	\$ 3.60	\$ 4.45	\$ 6.50

Case Pack: 6 Color/InStock Color: Translucent (190).

Note: All graduations are approximate.

*Seal covers fit Camwear CamSquare containers only.

**Dimensions include handles.



CAMSQUARE® FOOD STORAGE CONTAINERS



Translucent



CODE	2SFSP	4SFSP	6SFSP	8SFSP	12SFSP**	18SFSP**	22SFSP**
CAPACITY	2 qt.	4 qt.	6 qt.	8 qt.	12 qt.	18 qt.	22 qt.
DIM. L x W x H	7¼" x 7¼" x 3⅜"	7¼" x 7¼" x 7⅞"	8⅞" x 8⅞" x 7¼"	8⅞" x 8⅞" x 9⅞"	11¼" x 12¼" x 8¾"	11¼" x 12¼" x 12⅞"	11¼" x 12¼" x 15¾"
LIST PRICE EACH	\$ 6.95	\$ 9.55	\$ 11.85	\$ 14.05	\$ 19.80	\$ 26.95	\$ 33.20

Case Pack: 6 Color/InStock Color: Translucent (190). Height includes covers.

Poly

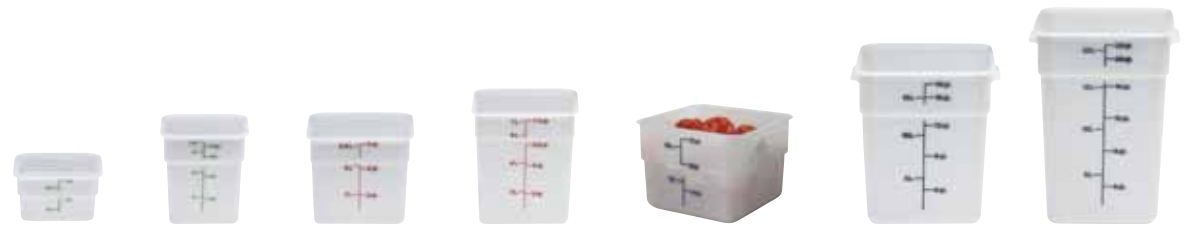

CODE	2SFSP	4SFSP	6SFSP	8SFSP	12SFSP**	18SFSP**	22SFSP**
CAPACITY	2 qt.	4 qt.	6 qt.	8 qt.	12 qt.	18 qt.	22 qt.
DIM. L x W x H	7¼" x 7¼" x 3⅜"	7¼" x 7¼" x 7⅞"	8⅞" x 8⅞" x 7¼"	8⅞" x 8⅞" x 9⅞"	11¼" x 12¼" x 8¾"	11¼" x 12¼" x 12⅞"	11¼" x 12¼" x 15¾"
LIST PRICE EACH	\$ 6.60	\$ 9.00	\$ 11.20	\$ 13.25	\$ 18.90	\$ 25.55	\$ 31.20

Case Pack: 6 Color: Natural White (148). Height includes covers.

Covers*



CODE	SFC2	SFC6	SFC12
COLOR	Kelly Green (452)	Winter Rose (451)	Midnight Blue (453)
DESCRIPTION	Fits 2 & 4 qt.	Fits 6 & 8 qt.	Fits 12, 18 & 22 qt.
LIST PRICE EACH	\$ 3.60	\$ 4.45	\$ 6.50

Case Pack: 6 Colors/InStock Colors: Kelly Green (452), Winter Rose (451), Midnight Blue (453).

Note: All graduations are approximate.

*PolyCovers fit Camwear, Translucent and Poly CamSquare Containers.

**Dimensions include handles.



CAMWEAR® ROUND FOOD STORAGE CONTAINERS



Store ingredients or transport ready to serve or partially prepared foods. Clear Camwear allows for easy content identification at a glance. Reduces risk of contamination and enhances food safety. Round shape promotes proper air circulation, ideal for stirring soups and sauces.

Note: All graduations are approximate.

Note: To order Round Food Storage Containers without imprinted graduations, simply add "N" to the end of the code number.

Lids are not interchangeable.



Seal Cover provides excellent spill resistance.

Crystal clear, virtually unbreakable Camwear withstands temperatures from -40° to 210°F (-40° to 99°C).

Molded-in handles ease carrying. Molded-in holes offer quick and sanitary drying.

Interstacking saves space when not in use.

Resists food acids, oils & alcohol. Stain and odor resistant.

Easy to read graduations on the outside for at a glance inventory management.



Camwear Covers

- Snap on covers fit tightly.
- Stain resistant to food acids and oils.
- Withstands temperatures from -40° to 210°F (-40° to 99°C).



Round Seal Covers

- Inner and outer seal provide excellent spill resistance.
- Safe from -40° to 160°F (-40° to 70°C).
- Thumb tab for easy removal.



ROUND FOOD STORAGE CONTAINERS

Translucent

- Translucent material offers some product visibility.
- Rounds are durable and resistant to stains.
- Withstands temperatures from -40° to 160°F (-40° to 70°C).
- Snap on covers fit tightly to protect contents and extend product freshness.

Note: All graduations are approximate.
Lids are not interchangeable.



Poly

- Impact, stain and chemical resistant material.
- An affordable storage choice.
- Safe from -40° to 160°F (-40° to 70°C).
- Snap on covers fit tightly yet are easily removed.

Note: All graduations are approximate.

Note: To order Round Food Storage Containers without imprinted graduations, simply add "N" to the end of the code number.

Lids are not interchangeable.



CAMWEAR® ROUND FOOD STORAGE CONTAINERS



Camwear



CODE	RFSCW1	RFSCW2	RFSCW4	RFSCW6	RFSCW8	RFSCW12	RFSCW18	RFSCW22
CAPACITY	1 qt.	2 qt.	4 qt.	6 qt.	8 qt.	12 qt.	18 qt.	22 qt.
DIMENSIONS	Top dia. 6 ¹ / ₁₆ " Height 5"	Top dia. 8 ³ / ₁₆ " Height 4 ³ / ₁₆ "	Top dia. 8 ³ / ₁₆ " Height 8 ¹ / ₁₆ "	Top dia. 9 ¹ / ₁₆ " Height 7 ¹⁵ / ₁₆ "	Top dia. 9 ¹ / ₁₆ " Height 10 ¹ / ₈ "	Top dia. 14 ¹ / ₈ " Height 8 ³ / ₈ "	Top dia. 14 ¹ / ₈ " Height 12"	Top dia. 14 ¹ / ₈ " Height 15"
CASE PACK	12	12	12	12	12	6	6	6
LIST PRICE EACH	\$ 6.65	\$ 9.20	\$ 15.55	\$ 18.20	\$ 23.05	\$ 32.55	\$ 44.65	\$ 51.40

Color/InStock Color: Clear (135). Top diameter dimension includes handle. Height dimension includes cover. Two year warranty on Camwear rounds.



Camwear Covers

DESCRIPTION	CASE PACK	CODE	LIST PRICE EA.
Fits 1 qt.	12	RFSCWC1	\$ 2.40
Fits 2 & 4	12	RFSCWC2	4.30
Fits 6 & 8	12	RFSCWC6	5.45
Fits 12, 18 & 22	6	RFSCWC12	12.45

Color/InStock Color: Clear (135).



Seal Covers for Camwear Rounds

DESCRIPTION	CASE PACK	CODE	LIST PRICE EA.
Fits 1 qt.	12	RFS1SCPP	\$ 2.15
Fits 2 & 4	12	RFS2SCPP	3.30
Fits 6 & 8	12	RFS6SCPP	3.40
Fits 12, 18 & 22	6	RFS12SCPP	7.30

Color/InStock Color: Translucent (190).

ROUND FOOD STORAGE CONTAINERS



Translucent



CODE	RFS1PP	RFS2PP	RFS4PP	RFS6PP	RFS8PP	RFS12PP	RFS18PP	RFS22PP
CAPACITY	1 qt.	2 qt.	4 qt.	6 qt.	8 qt.	12 qt.	18 qt.	22 qt.
DIMENSIONS	Top dia. 6 $\frac{1}{16}$ " Height 5"	Top dia. 8 $\frac{3}{16}$ " Height 4 $\frac{1}{16}$ "	Top dia. 8 $\frac{3}{16}$ " Height 8 $\frac{3}{16}$ "	Top dia. 9 $\frac{15}{16}$ " Height 7 $\frac{15}{16}$ "	Top dia. 9 $\frac{15}{16}$ " Height 10 $\frac{1}{8}$ "	Top dia. 14 $\frac{7}{8}$ " Height 8 $\frac{3}{8}$ "	Top dia. 14 $\frac{7}{8}$ " Height 12"	Top dia. 14 $\frac{7}{8}$ " Height 15"
CASE PACK	12	12	12	12	12	6	6	6
LIST PRICE EACH	\$ 4.45	\$ 4.95	\$ 5.75	\$ 6.95	\$ 9.25	\$ 16.50	\$ 20.00	\$ 23.50

Color/InStock Color: Translucent (190). Top diameter dimension includes handle. Height dimension includes cover.

Poly



CODE	RFS1	RFS2	RFS4	RFS6	RFS8	RFS12	RFS18	RFS22
CAPACITY	1 qt.	2 qt.	4 qt.	6 qt.	8 qt.	12 qt.	18 qt.	22 qt.
DIMENSIONS	Top dia. 6 $\frac{1}{16}$ " Height 5"	Top dia. 8 $\frac{3}{16}$ " Height 4 $\frac{1}{16}$ "	Top dia. 8 $\frac{3}{16}$ " Height 8 $\frac{3}{16}$ "	Top dia. 9 $\frac{15}{16}$ " Height 7 $\frac{15}{16}$ "	Top dia. 9 $\frac{15}{16}$ " Height 10 $\frac{1}{8}$ "	Top dia. 14 $\frac{7}{8}$ " Height 8 $\frac{3}{8}$ "	Top dia. 14 $\frac{7}{8}$ " Height 12"	Top dia. 14 $\frac{7}{8}$ " Height 15"
CASE PACK	12	12	12	12	12	6	6	6
LIST PRICE EACH	\$ 4.30	\$ 4.65	\$ 5.30	\$ 6.60	\$ 8.65	\$ 15.50	\$ 18.80	\$ 22.15

Color: Natural White (148). Top diameter dimension includes handle. Height dimension includes cover.

Covers for Translucent Rounds

DESCRIPTION	CASE PACK	CODE	LIST PRICE EA.
Fits 1 qt.	12	RFSC1PP	\$ 1.65
Fits 2 & 4	12	RFSC2PP	1.70
Fits 6 & 8	12	RFSC6PP	2.45
Fits 12, 18 & 22	6	RFSC12PP	5.65

Color/InStock Color: Translucent (190).

Covers for Poly Rounds

DESCRIPTION	CASE PACK	CODE	LIST PRICE EA.
Fits 1 qt.	12	RFSC1	\$ 1.45
Fits 2 & 4	12	RFSC2	1.50
Fits 6 & 8	12	RFSC6	2.15
Fits 12, 18 & 22	6	RFSC12	5.15

Color: Natural White (148).

CAMWEAR® FOOD STORAGE BOXES — ELIMINATE THE HAZARD OF CROSS CONTAMINATION



Extend the freshness of ingredients and eliminate points of cross contamination by transferring product into food boxes at the receiving dock. A safe solution for storing bulk fruits and vegetables. Clear Camwear allows visibility for product identification. Snap tight Camwear covers or SlidingLids™, sold separately, won't come off during transportation.

SlidingLids are covered by the following U.S. Patents D 447,906 S & 6,540,098 B1.

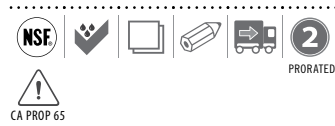

Withstands temperatures from -40° to 210°F (-40° to 99°C) for use in coolers and freezers.

SlidingLid provides easy access.

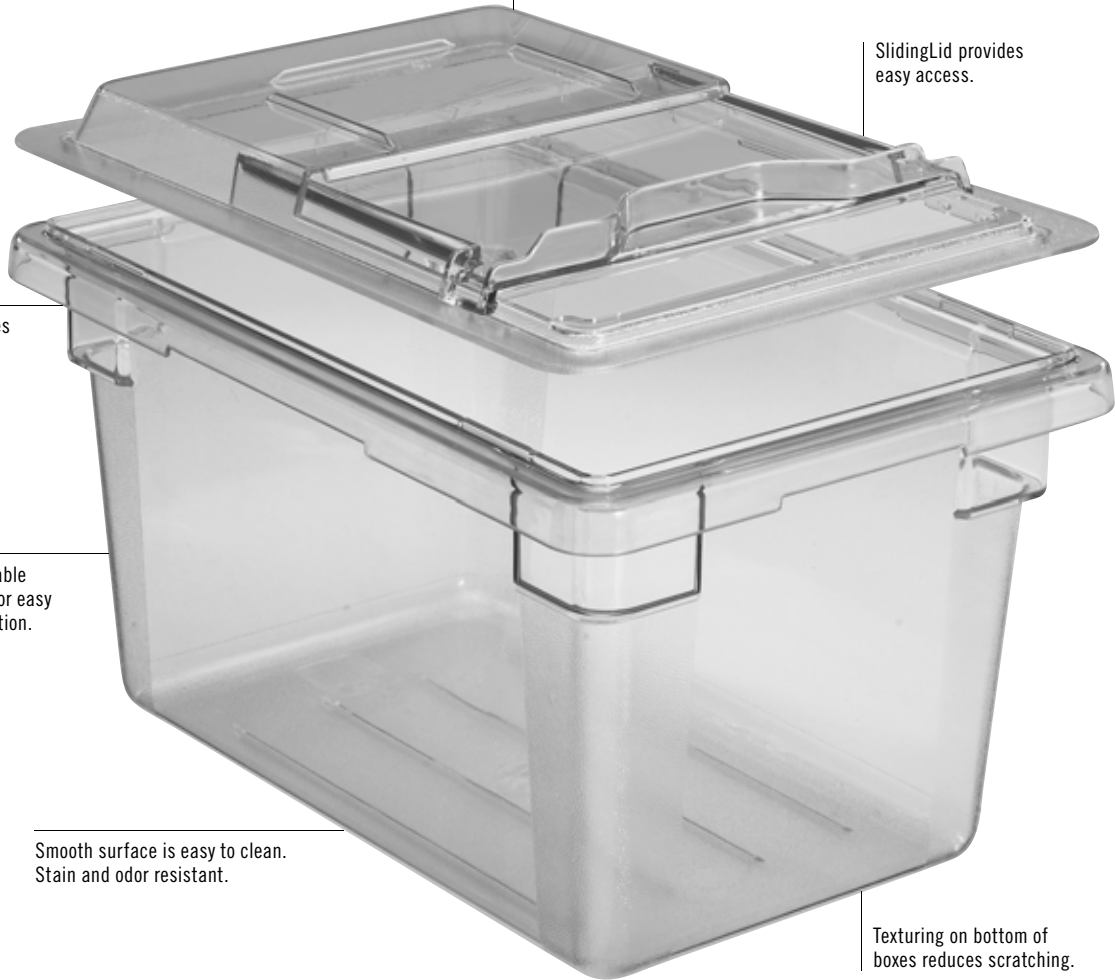

Molded-in handles ease carrying.

Crystal clear, durable Camwear allows for easy product identification.

Smooth surface is easy to clean. Stain and odor resistant.

Texturing on bottom of boxes reduces scratching.

Camwear Flat Lids

- Snap-tight covers won't come off during transport.
- Top molded-in rails for safer, more secure stacking.
- Durable Camwear is safe from -40° to 210°F (-40° to 99°C).

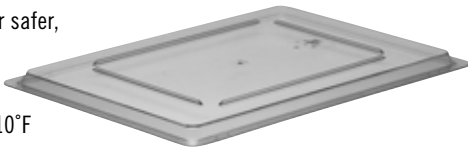

Camwear SlidingLids fits Camwear Food Storage Boxes

- Lid slides back to easily access contents, minimizing handling.
- Reduces the risk of cross contamination since lid remains on food box.
- Made of virtually unbreakable Camwear.



FOOD STORAGE BOXES

ColanderKits™

- A complete food safety system packaged in one carton.
- Store raw meats, fish on ice or bulk produce safely.
- Juices and liquids drip into the food box below for quick and easy disposal.
- Reduces handling and risk of cross contamination.



Camwear® Colanders

- Enhances food quality and reduces risk of cross contamination.
- Liquids and juices drain directly into food box for improved food safety.
- Ideal for draining fruits and vegetables, thawing meat or poultry, or storing seafood on ice.



Camwear Drain Shelves

- Lifts contents out of liquids to enhance food quality and freshness.
- Made of virtually unbreakable Camwear.
- Camwear drain shelves fit in both Camwear boxes and white poly boxes.



Poly Food Storage Boxes

- Economical choice for storing bulk produce and ingredients.
- Impact, stain and chemical resistant material.
- Withstands temperatures from -40° to 160°F (-40° to 70°C).



Camwear Safety Red and Yellow Food Storage Boxes

- Helps prevent cross-contamination between raw meats, poultry and other food products.
- Red and translucent yellow color clearly identifies product inside.
- Matching flat cover also available.



CAMWEAR® FOOD BOXES



Camwear Boxes



CODE	18263CW	❖ ● 18266CW	18269CW
DIMENSIONS	18" x 26" x 3½"	18" x 26" x 6"	18" x 26" x 9"
APPROX. CAPACITY	5 gal.	8.75 gal.	13 gal.
CASE PACK	6	6	4
LIST PRICE EACH	\$ 44.00	\$ 57.00	\$ 75.00



CODE	182612CW	182615CW	12183CW	❖ ● 12186CW	❖ 12189CW
DIMENSIONS	18" x 26" x 12"	18" x 26" x 15"	12" x 18" x 3½"	12" x 18" x 6"	12" x 18" x 9"
APPROX. CAPACITY	17 gal.	22 gal.	1.75 gal.	3 gal.	4.75 gal.
CASE PACK	4	3	6	6	6
LIST PRICE EACH	\$ 91.35	\$ 107.80	\$ 24.10	\$ 30.50	\$ 41.00

Color/InStock Color: Clear (135). 18266CW & 12186CW are available in Safety Yellow & Red.

● Safety Red (467). ❖ Safety Yellow (464) Contact your Cambro representative for pricing information.



Camwear Covers

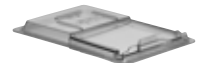
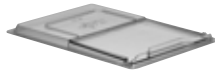

CODE	❖ ● 1826CCW FLAT LID	1826SCCW SLIDINGLID	❖ ● 1218CCW FLAT LID	1218SCCW SLIDINGLID™
DIMENSIONS	18" x 26"	18" x 26"	12" x 18"	12" x 18"
LIST PRICE EACH	\$ 29.85	\$ 53.45	\$ 14.90	\$ 31.80

Case Pack: 6 Color/InStock Color: Clear (135). 1826CCW & 1218CCW are available in Safety Yellow & Red.

● Safety Red (467). ❖ Safety Yellow (464) Contact your Cambro representative for pricing information.



FOOD STORAGE BOXES



Poly Boxes



CODE	18263P	18266P	18269P
DIMENSIONS	18" x 26" x 3½"	18" x 26" x 6"	18" x 26" x 9"
APPROX. CAPACITY	5 gal.	8.75 gal.	13 gal.
CASE PACK	6	6	6
LIST PRICE EACH	\$ 32.05	\$ 42.05	\$ 54.85



CODE	182612P	182615P	12183P	12186P	12189P
DIMENSIONS	18" x 26" x 12"	18" x 26" x 15"	12" x 18" x 3½"	12" x 18" x 6"	12" x 18" x 9"
APPROX. CAPACITY	17 gal.	22 gal.	1.75 gal.	3 gal.	4.75 gal.
CASE PACK	4	3	6	6	6
LIST PRICE EACH	\$ 66.50	\$ 78.25	\$ 19.35	\$ 24.15	\$ 31.90

Color/InStock Color: Natural White (148).

Poly Covers



CODE	1826CP FLAT LID	1218CP FLAT LID
DIMENSIONS	18" x 26"	12" x 18"
LIST PRICE EACH	\$ 24.70	\$ 14.85

Camwear and Poly Lids are not interchangeable.

Case Pack: 6 Color/InStock Color: Natural White (148).

Accessories

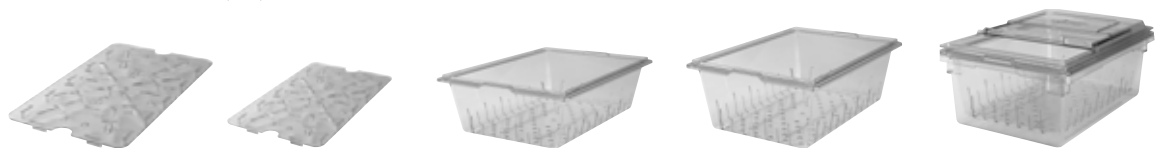

CODE	1826DSCW	1218DSCW	1826CLRCW (5" DEEP)	18268CLRCW (8" DEEP)	18268CLRKIT
DESCRIPTION	Drain shelf	Drain shelf	Colander	Colander	ColanderKit™
DIMENSIONS	Fits 18" x 26" food storage boxes	Fits 12" x 18" food storage boxes	Fits Camwear food storage boxes 18" x 26" x 6" and deeper	Fits Camwear food storage boxes 18" x 26" x 9" and deeper	One 8" deep colander One 18" x 26" x 9" food box One 18" x 26" SlidingLid™
CASE PACK	6	6	6	4	1 Kit
LIST PRICE EACH	\$ 24.55	\$ 9.70	\$ 47.15	\$ 81.55	\$ 209.95

Color/InStock Color: Clear (135).



STORESAFE® FOOD ROTATION LABELS



- Label and adhesive dissolve in less than 30 seconds.
- Leaves behind no sticky residue which can be a breeding ground for bacteria.
- Assists in a proper First In First Out (FIFO) food storage system.
- Run under hot or cold water or through the dishwasher.
- Safe for all sewer and septic systems. Will not build up in drains.
- Withstands high heat temperatures up to 200°F (93°C) for 4 hours. Microwave safe.
- Withstands freezer temperatures up to -40°F (-40°C).

Label color: White.

 *Available for ordering in cases only.
 No broken cartons.

 100% biodegradable.
 FDA approved material.



Eliminates sticky residue and prevents cross contamination! No more scraping!



Dissolves completely within 30 seconds off all containers when placed through dishwasher or under running water.



Retail Blister Pack

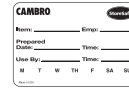

CASE CODE	23SL
LABEL SIZE	2" x 3"
CASE PACK	20 rolls, 100 labels per roll
LIST PRICE CASE	\$ 381.10

StoreSafe Label Blister Pack is covered by U.S. Patent 690,589 S.



Half Size Bulk Dispenser Pack



CASE CODE	1252SLB250	1252SLINB250
LABEL SIZE	1¼" x 2"	1¼" x 2"
CASE PACK	24 rolls, 250 labels per roll	24 rolls, 250 labels per roll
LIST PRICE CASE	\$ 350.20	\$ 350.20

Bulk Dispenser Pack

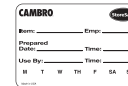
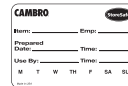

CASE CODE	23SLB250	23SLB6250
LABEL SIZE	2" x 3"	2" x 3"
CASE PACK	24 rolls, 250 labels per roll	6 rolls, 250 labels per roll
LIST PRICE CASE	\$ 705.55	\$ 183.35

Blank Bulk Dispenser Pack

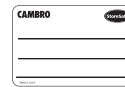

CASE CODE	23SLINB250
LABEL SIZE	2" x 3"
CASE PACK	24 rolls, 250 labels per roll
LIST PRICE CASE	\$ 705.55

Laser Sheet



CASE CODE	SLL30
LABEL SIZE	1" x 2½" (Avery® 5160)
CASE PACK	100 sheets, 30 labels per sheet 8½" x 11" sheet size
LIST PRICE CASE	\$ 180.25





CAMWEAR® FOOD PANS

Store, transport and serve all in one pan. Camwear food pans are made from durable Camwear that will not crack, bend or dent. Precisely designed to Gastronorm GN specifications, with a large radius bottom to reduce food waste. At half the cost of stainless steel, Camwear pans keep contents as cold as metal pans with less condensation. Pans stack neatly without wedging or sticking.

Colors: Clear (135), White (148), Black (110). Except 18CW and 28CW available in Clear (135) only.

Camwear pans are not recommended for steam table or microwave use. See X-Pan® and H-Pan™ section for high heat applications.

Colander Pan is covered by U.S. Patent D 528,376.

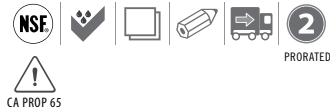

Uniform 1/2" (1,27 cm) flange ensures a smooth fit in prep tables and food bars.

Virtually unbreakable Camwear withstands temperatures from -40° to 210°F (-40° to 99°C).

Molded-in graduations in standard & metric for easy inventory management.

Won't react with food; minimizes potentially hazardous chemical or acidic reaction.



Non-stick smooth interior surface increases yields and promotes easy cleaning.

Textured bottoms resist scratching.



Cold Test

Tests prove Camwear food pans keep products as cold as stainless steel. Stainless may feel colder, but as these test results demonstrate, Camwear food pans keep products just as cold for just as long.



CAMWEAR PANS

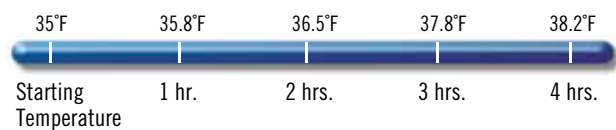

STAINLESS STEEL PANS

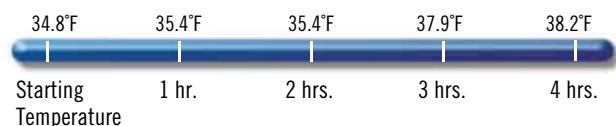

CAMWEAR® FOOD PANS



FULL SIZE

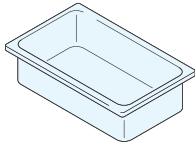

CONFIGURATIONS	PAN CODE	PAN DEPTH	APPROXIMATE CAPACITY	LIST PRICE EA.
GN 1/1 12¾" x 20⅞" (32,5 x 53 cm)	12CW	2½" (6,5 cm)	8.9 qt.	\$ 21.35
	14CW	4" (10)	13.7	27.15
	16CW	6" (15)	20.6	32.95
	18CW	8" (20)	27	39.35
	10CWD	—	Drain shelf	15.50

HALF SIZE LONG

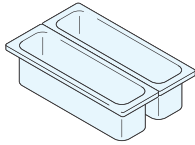

GN 1/2 Long 6⅞" x 20⅞" (16,2 x 53 cm)	22LPCW	2½" (6,5)	3.2	16.20
	24LPCW	4" (10)	5.3	20.20
	20LPCWD	—	Drain shelf	8.05

HALF SIZE

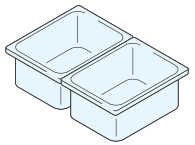

GN 1/2 10⅞" x 12¾" (26,5 x 32,5 cm)	22CW	2½" (6,5)	4.1	11.85
	24CW	4" (10)	6.3	14.75
	26CW	6" (15)	9.4	18.95
	28CW	8" (20)	12.4	24.10
	20CWD	—	Drain shelf	7.20

ONE THIRD SIZE

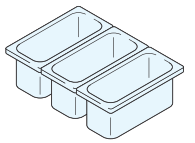

GN 1/3 6⅞" x 12¾" (17,6 x 32,5 cm)	32CW	2½" (6,5)	2.5	8.90
	34CW	4" (10)	3.8	12.25
	36CW	6" (15)	5.6	14.30
	38CW	8" (20)	7.3	18.30
	30CWD	—	Drain shelf	6.65

QUARTER SIZE

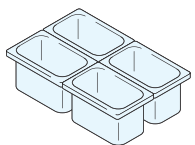

GN 1/4 6⅞" x 10⅞" (16,2 x 26,5 cm)	42CW	2½" (6,5)	1.8	9.00
	44CW	4" (10)	2.7	10.60
	46CW	6" (15)	3.9	12.25
	40CWD	—	Drain shelf	5.55

ONE SIXTH SIZE

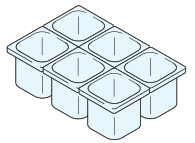

GN 1/6 6⅞" x 6⅞" (16,2 x 17,6 cm)	62CW	2½" (6,5)	1.1	6.55
	64CW	4" (10)	1.6	7.40
	66CW	6" (15)	2.4	9.90
	60CWD	—	Drain shelf	2.95

ONE EIGHTH SIZE

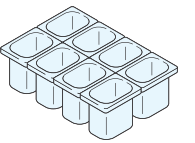

GN 1/8 6⅞" x 5⅞" (16,12 x 13,17 cm)	82CW*	2½" (6,5)	0.7	6.60
	84CW	4" (10)	1.1	7.75
	86CW	6" (15)	1.5	10.25
	80CWD	—	Drain shelf	2.60

ONE NINTH SIZE

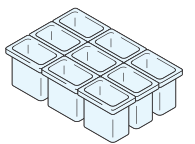

GN 1/9 4¼" x 6⅞" (10,8 x 17,6 cm)	92CW	2½" (6,5)	0.6	6.65
	94CW	4" (10)	0.9	8.10
	96PCW New!	6" (15)	1.4	10.15
	90CWD	—	Drain shelf	2.25

Case Pack for all Pans: 6. Lids listed on page 159.

InStock Color: Clear (135).

96PCW InStock Color: Clear (135), Black (110).

Colors: Clear (135), White (148), Black (110). *82CW is not available in Black (110). 18CW, 28CW and Drain Shelves available in Clear (135) only.

All Camwear food pans are made of FDA approved materials. All Camwear food pans are designed to GEN Gastronorm Standard EN 631-1.

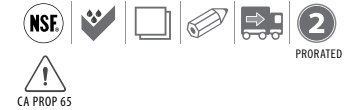

Drain Shelves

- Supports products and promotes drainage.
- Available to fit all pan sizes.



See next page for colanders.



96PCW

CAMWEAR® LIDS



Flat Cover

Available in all pan sizes.



Cover with Handle

Deep molded handle provides secure grip and also includes a peg hole for sanitary drying. Available in black to help block light, reducing discoloration of meats and cheeses.



Notched Cover with Handle

Notched cover allows utensils to remain in pan and off of potentially contaminated counters. Includes peg hole for sanitary drying.



Seal Cover

Designed to fit Camwear and translucent food pans, Seal Covers feature an inner seal that provides superior spill resistance and extends shelf life up to 3 days.



FlipLid®

Flip up lid to easily access contents. Food can be held without getting dried out, increasing yields. Reduces points of cross contamination.



Notched FlipLid

FlipLid with notch to rest spoon in contents with lid closed.



GripLid®

Molded-in polyurethane gasket on the lid grips the side of the food pan, reducing spills and points of cross-contamination.

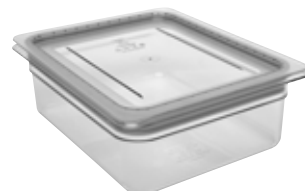

FITS PAN	LID CODE	DESCRIPTION	LIST PRICE EA.
GN 1/1 12 ³ / ₄ " x 20 ⁷ / ₈ " (32,5 x 53 cm)	10CWC	Flat cover	\$ 18.00
	10CWCH*	Cover with handle	18.00
	10CWCHN*	Notched cover w/handle	18.00
	10CWGL	GripLid	37.95
	10PPCWSC	Seal cover	11.95
GN 1/2 Long 6 ³ / ₈ " x 20 ⁷ / ₈ " (16,2 x 53 cm)	20LPCWC	Flat cover	13.80
GN 1/2 10 ¹ / ₁₆ " x 12 ³ / ₄ " (26,5 x 32,5 cm)	20CWC	Flat cover	9.40
	20CWCH*	Cover with handle	9.40
	20CWCHN*	Notched cover w/handle	11.00
	20CWL	FlipLid	14.85
	20CWLN	Notched FlipLid	14.85
	20CWGL	GripLid	26.35
	20PPCWSC	Seal cover	7.30
GN 1/3 6 ¹⁵ / ₁₆ " x 12 ³ / ₄ " (17,6 x 32,5 cm)	30CWC	Flat cover	6.90
	30CWCH*	Cover with handle	6.90
	30CWCHN*	Notched cover w/handle	9.40
	30CWL	FlipLid	12.70
	30CWLN	Notched FlipLid	12.70
	30CWGL	GripLid	18.15
	30PPCWSC	Seal cover	5.50
GN 1/4 6 ³ / ₈ " x 10 ⁷ / ₁₆ " (16,2 x 26,5 cm)	40CWC	Flat cover	6.25
	40CWCH*	Cover with handle	6.25
	40CWCHN*	Notched cover w/handle	6.25
	40PPCWSC	Seal cover	4.85
GN 1/6 6 ³ / ₈ " x 6 ¹⁵ / ₁₆ " (16,2 x 17,6 cm)	60CWC	Flat cover	4.90
	60CWCH*	Cover with handle	5.40
	60CWCHN*	Notched cover w/handle	5.40
	60CWL	FlipLid	7.20
	60CWLN	Notched FlipLid	7.20
	60CWGL	GripLid	14.90
	60PPCWSC	Seal cover	3.75
GN 1/8 6 ¹⁵ / ₁₆ " x 5 ³ / ₁₆ " (16,12 x 13,17 cm)	80CWC	Flat cover	5.20
	80CWCH*	Cover with handle	5.70
	80CWCHN*	Notched cover with handle	5.70
	80PPCWSC	Seal cover	3.60
GN 1/9 4 ¹ / ₄ " x 6 ¹⁵ / ₁₆ " (10,8 x 17,6 cm)	90CWC*	Flat cover	5.50
	90CWCN	Flat notched cover	5.50
	90PPCWSC	Seal cover	3.35

Case Pack for all Lids: 6 InStock Color: Clear (135).

*Includes peg hole.

Color: Clear (135).

Seal Cover Color: Translucent (190).

Cover with Handle Colors: Clear (135), Black (110).

FlipLids are covered by U.S. Patent D 420,849, D 422,838 & D 427,012.

GripLids are covered by U.S. Patent D 446,076 & Utility Patent 6,273,288 B1.



X-PAN® HIGH HEAT FOOD PANS

Reduce handling and save expense with one pan that can go from prep to cooler to oven to steam table. X-Pan food pans are designed to Gastronorm GN specifications. Unlike metal pans, they are safe for use in heating and holding applications. Ideal for heated carts, steam tables and chafing dishes.

Color: Sandstone (772).
 X-Pan food pans are made of FDA approved materials and are designed to CEN Gastronorm Standard EN 631-1. Colors may vary.



New!

Uniform 1/2" (1,27 cm) flange ensures a smooth fit in steam tables and food bars.

Great for flash freezing and reheating in microwave ovens.



Pans stack neatly, without wedging or sticking.



Non-stick smooth interior surface increases yields and promotes easy cleaning.

Made from FDA approved material that withstands temperatures from -40° to 375°F (-40° to 190°C).



X-PAN® HIGH HEAT FOOD PANS



FULL SIZE

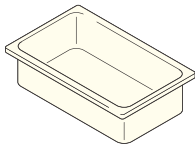

CONFIGURATIONS	PAN CODE	PAN DEPTH	APPROXIMATE CAPACITY	LIST PRICE EA.
GN 1/1 12¾" x 20⅞" (32,5 x 53 cm)	12HP	2½" (6,5 cm)	8.9 qt.	\$ 64.10
	14HP	4" (10)	13.7	77.55
	16HP	6" (15)	20.6	100.80
	10HPD*	—	Drain shelf	42.45

Color: Sandstone (772).
Drain Shelf Color: Amber (150).

X-Pan food pans and drain shelves are made of FDA approved material and are designed to CEN Gastronorm Standard EN 631-1. Colors may vary.



HALF SIZE

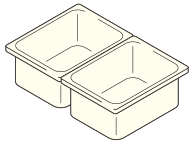

GN 1/2 10⅞" x 12¾" (26,5 x 32,5 cm)	22HP	2½" (6,5)	4.1	31.95
	24HP	4" (10)	6.3	41.55
	26HP	6" (15)	9.4	53.25
	20HPD*	—	Drain shelf	19.05

ONE THIRD SIZE

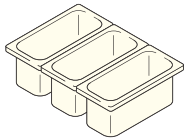

GN 1/3 6⅞" x 12¾" (17,6 x 32,5 cm)	32HP	2½" (6,5)	2.5	26.75
	34HP	4" (10)	3.8	34.65
	36HP	6" (15)	5.6	47.15
	30HPD*	—	Drain shelf	14.30

QUARTER SIZE

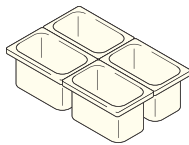

GN 1/4 6⅞" x 10⅞" (16,2 x 26,5 cm)	42HP	2½" (6,5)	1.8	23.15
	44HP	4" (10)	2.7	28.60
	46HP	6" (15)	3.9	36.65
	40HPD*	—	Drain shelf	14.30

ONE SIXTH SIZE

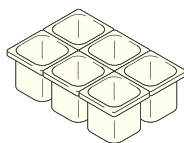

GN 1/6 6⅞" x 6⅞" (16,2 x 17,6 cm)	62HP	2½" (6,5)	1.1	18.10
	64HP	4" (10)	1.6	21.85
	66HP	6" (15)	2.4	26.50
	60HPD*	—	Drain shelf	7.35

ONE EIGHTH SIZE

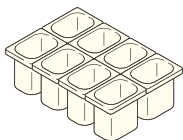

GN 1/8 6⅞" x 5⅞" (16,12 x 13,17 cm)	82HP	2½" (6,5)	0.7	15.85
	84HP	4" (10)	1.1	20.05
	86HP	6" (15)	1.5	25.85
	80HPD*	—	Drain shelf	6.45

ONE NINTH SIZE

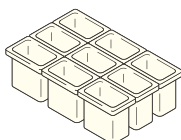

GN 1/9 4⅞" x 6⅞" (10,8 x 17,6 cm)	92HP	2½" (6,5)	0.6	13.70
	94HP	4" (10)	0.9	16.00
	90HPD*	—	Drain shelf	5.45

Case Pack: 6 Lids listed on page 165.

*Drain shelf available in Amber (150) only.

InStock Color: Amber (150) (Drain shelf only), Sandstone (772).

Drain Shelf

- Supports product and promotes drainage.
- Available to fit all food pan sizes.



Colanders listed on page 164.



34HP

H-PAN™ HIGH HEAT FOOD PANS

Reduce handling and save expense with one pan that can go from prep to cooler to oven to steam table.

H-Pans are designed to Gastronorm GN specifications. Unlike metal pans, H-Pans are safe for use in heating and holding applications. Ideal for heated carts, steam tables and chafing dishes. H-Pans have both standard and metric graduation markings to promote easy inventory management.

Colors: Amber (150), Black (110).

H-Pans are made of FDA approved material and are designed to CEN Gastronorm Standard EN 631-1. Amber color may vary.



Uniform 1/2" (1,27 cm) flange ensures a smooth fit in prep tables and food bars.



Great for flash freezing and reheating.

Pans stack neatly, without wedging or sticking.



Made from FDA approved material that withstands temperatures from -40° to 375°F (-40° to 190°C).

Non-stick smooth interior surface increases yields and promotes easy cleaning.



H-PAN™ HIGH HEAT FOOD PANS

FULL SIZE

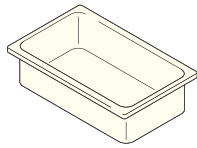

CONFIGURATIONS	PAN CODE	PAN DEPTH	APPROXIMATE CAPACITY	LIST PRICE EA.
GN 1/1 12 ³ / ₄ " x 20 ⁷ / ₈ " (32,5 x 53 cm)	12HP	2 ¹ / ₂ " (6,5 cm)	8.9 qt.	\$ 64.10
	14HP	4" (10)	13.7	77.55
	16HP	6" (15)	20.6	100.80
	10HPD*	—	Drain shelf	42.45

HALF SIZE LONG

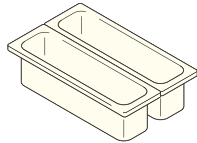

GN 1/2 Long 6 ³ / ₈ " x 20 ⁷ / ₈ " (16,2 x 53 cm)	22LPHP	2 ¹ / ₂ " (6,5)	3.2	45.60
	24LPHP	4" (10)	5.3	56.70
	20LPHPD*	—	Drain shelf	21.20

HALF SIZE

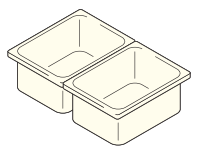

GN 1/2 10 ¹ / ₁₆ " x 12 ³ / ₄ " (26,5 x 32,5 cm)	22HP	2 ¹ / ₂ " (6,5)	4.1	31.95
	24HP	4" (10)	6.3	41.55
	26HP	6" (15)	9.4	53.25
	20HPD*	—	Drain shelf	19.05

ONE THIRD SIZE

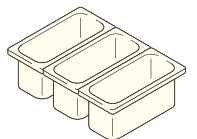

GN 1/3 6 ¹ / ₁₆ " x 12 ³ / ₄ " (17,6 x 32,5 cm)	32HP	2 ¹ / ₂ " (6,5)	2.5	26.75
	34HP	4" (10)	3.8	34.65
	36HP	6" (15)	5.6	47.15
	30HPD*	—	Drain shelf	14.30

QUARTER SIZE

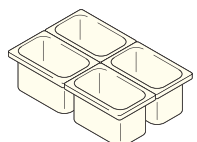

GN 1/4 6 ³ / ₈ " x 10 ¹ / ₁₆ " (16,2 x 26,5 cm)	42HP	2 ¹ / ₂ " (6,5)	1.8	23.15
	44HP	4" (10)	2.7	28.60
	46HP	6" (15)	3.9	36.65
	40HPD*	—	Drain shelf	14.30

ONE SIXTH SIZE

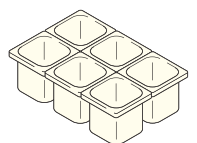

GN 1/6 6 ³ / ₈ " x 6 ¹ / ₁₆ " (16,2 x 17,6 cm)	62HP	2 ¹ / ₂ " (6,5)	1.1	18.10
	64HP	4" (10)	1.6	21.85
	66HP	6" (15)	2.4	26.50
	60HPD*	—	Drain shelf	7.35

ONE EIGHTH SIZE

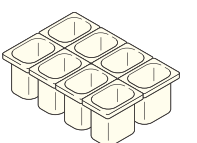

GN 1/8 6 ³ / ₁₆ " x 5 ¹ / ₁₆ " (16,12 x 13,17 cm)	82HP	2 ¹ / ₂ " (6,5)	0.7	15.85
	84HP	4" (10)	1.1	20.05
	86HP	6" (15)	1.5	25.85
	80HPD*	—	Drain shelf	6.45

ONE NINTH SIZE

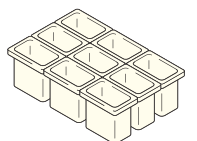

GN 1/9 4 ¹ / ₄ " x 6 ¹ / ₁₆ " (10,8 x 17,6 cm)	92HP	2 ¹ / ₂ " (6,5)	0.6	13.70
	94HP	4" (10)	0.9	16.00
	96PHP New!	6" (15)	1.4	22.75
	90HPD*	—	Drain shelf	5.45

Case Pack: 6 Lids listed on page 165.

*Drain shelf available in Amber (150) only. **InStock Color:** Amber (150).

Colors: Amber (150), Black (110).
Drain Shelf Color: Amber (150).

H-Pans are made of FDA approved materials and are designed to CEN Gastronorm Standard EN 631-1. Amber color may vary.



Drain Shelf

- Supports product and promotes drainage.
- Available to fit all food pan sizes.



Colanders listed on page 164.



86HP

H-PAN™ HIGH HEAT COLANDER PANS

- Colanders drain liquids and grease away from hot foods, improving food quality.
- Ideal for reheating in microwaves and holding applications such as steam tables and buffet lines.
- Reduces handling and improves food safety.
- H-Pan flat covers, covers with handles and notched covers with handles fit on pans with colanders.



Microwave/Steam



Hold Hot Foods



Drain

CONFIGURATIONS	PAN CODE	COLANDER DEPTH	FITS H-PAN DEPTH	LIST PRICE EA.
GN 1/1 12 ³ / ₄ " x 20 ⁷ / ₈ " (32,5 x 53 cm)	13CLRHP	3" (7,6 cm)	4" (10 cm)	\$ 77.55
	15CLRHP	5" (12,7)	6" (15)	100.80
GN 1/2 10 ⁷ / ₁₆ " x 12 ³ / ₄ " (26,5 x 32,5 cm)	23CLRHP	3" (7,6)	4" (10)	41.55
	25CLRHP	5" (12,7)	6" (15)	53.25
GN 1/3 6 ¹⁵ / ₁₆ " x 12 ³ / ₄ " (17,6 x 32,5 cm)	33CLRHP	3" (7,6)	4" (10)	34.65
	35CLRHP	5" (12,7)	6" (15)	47.15
GN 1/6 6 ³ / ₈ " x 6 ¹⁵ / ₁₆ " (16,2 x 17,6 cm)	63CLRHP	3" (7,6)	4" (10)	21.85
	65CLRHP	5" (12,7)	6" (15)	26.50

Case Pack: 6. Lids listed on following page. **Color:** Amber (150).



LIDS FOR H-PAN™ AND X-PAN® FOOD PANS



Flat Cover

Available in all pan sizes.



FITS PAN	LID CODE	DESCRIPTION	LIST PRICE EA.
GN 1/1 12 ³ / ₄ " x 20 ⁷ / ₈ " (32,5 x 53 cm)	10HPC	Flat cover	\$ 57.55
	10HPCH	Cover with handle	57.55
	10HPCHN	Notched cover w/handle	57.60

GN 1/2 Long 6 ³ / ₈ " x 20 ⁷ / ₈ " (16,2 x 53 cm)	20LPHPC	Flat cover	34.35
---	---------	------------	-------

Cover with Handle

Deep molded handle gives secure grip.



GN 1/2 10 ¹ / ₄ " x 12 ³ / ₄ " (26,5 x 32,5 cm)	20HPC	Flat cover	25.05
	20HPCH	Cover with handle	26.55
	20HPCHN	Notched cover w/handle	30.45
	20HPL	FlipLid	44.10
	20HPLN	Notched FlipLid	44.10

Notched Cover with Handle

Easy access for ladles or spoons.



GN 1/3 6 ¹⁵ / ₁₆ " x 12 ³ / ₄ " (17,6 x 32,5 cm)	30HPC	Flat cover	18.70
	30HPCH	Cover with handle	21.10
	30HPCHN	Notched cover w/handle	21.10
	30HPL	FlipLid	31.50
	30HPLN	Notched FlipLid	31.50

GN 1/4 6 ³ / ₈ " x 10 ⁷ / ₁₆ " (16,2 x 26,5 cm)	40HPC	Flat cover	15.20
	40HPCH	Cover with handle	16.35
	40HPCHN	Notched cover w/handle	16.55

FlipLid®

Flip up lid to easily access contents. Food can be held without getting dried out, increasing yields.



GN 1/6 6 ³ / ₈ " x 6 ¹⁵ / ₁₆ " (16,2 x 17,6 cm)	60HPC	Flat cover	13.25
	60HPCH	Cover with handle	13.25
	60HPCHN	Notched cover w/handle	13.25
	60HPL	FlipLid	18.05
	60HPLN	Notched FlipLid	18.05

GN 1/8 6 ⁵ / ₁₆ " x 5 ⁵ / ₁₆ " (16,12 x 13,17 cm)	80HPC	Flat cover	11.15
	80HPCH	Cover with handle	11.15
	80HPCHN	Notched cover w/handle	11.15

Notched FlipLid®

FlipLid with notch to rest spoon in contents with lid closed.



GN 1/9 4 ¹ / ₄ " x 6 ¹⁵ / ₁₆ " (10,8 x 17,6 cm)	90HPC	Flat cover	9.10
---	-------	------------	------

Case Pack for all Lids: 6 InStock Color: Amber (150).

Color: Amber (150).
Amber color may vary.

FlipLids are covered by U.S. Patent D 420,849, D 422,838 & D 427,012 & Patent 6,273,288 B1.
GripLids are covered by U.S. Patent D 446,076.



HIGH HEAT H-PAN™ WITH HANDLE(S)



- Flat base to maximize contact with heating element.
- High heat material withstands temperatures from -40° to 375°F (-40° to 190°C).
- Fits all leading manufacturer's product holding units (PHU), including single-sided and pass-through models.
- Reinforced textured handle design with finger grip feature for a secure grasp.
- Handle designed with drain holes to avoid water build-up after warewashing process.

Color: Amber (150).
 32HP2H is covered by U.S. Patent D797,493 S



32HP2H



32HP1H

CONFIGURATIONS	PAN CODE	DESCRIPTION	PAN DEPTH	APPROX. CAPACITY	LIST PRICE EA.
1/3 6 ¹⁵ / ₁₆ " x 12 ³ / ₄ " (17,6 x 32,5 cm)	32HP1H	Single Handle	2 ¹ / ₂ " (6,5 cm)	2.5 qt.	\$ 41.00
	32HP2H	Double Handle	2 ¹ / ₂ " (6,5)	2.5	42.00

Case Pack: 6 Color/InStock Color: Amber (150).

H-PAN WITH HANDLES

- Full size 2¹/₂" deep food pan with handles fits all leading product holding units (PHU).
- High Heat Material withstands temperatures from -40° to 375°F (-40° to 190°C).
- Two handles allow employees to reach the pan from either side of the unit for safe handling.



12HPH

CONFIGURATIONS	PAN CODE	PAN DEPTH	APPROX. CAPACITY	LIST PRICE EA.
1/1 12 ³ / ₄ " x 20 ⁷ / ₈ " (32,5 x 53 cm)	12HPH	2 ¹ / ₂ " (6,5 cm)	8.9 qt.	\$ 73.70

Case Pack: 6 Color/InStock Color: Amber (150).
 Lids listed on previous page.

TRANSLUCENT FOOD PANS

- An economical choice for storing food.
- Translucent polypropylene material provides content visibility and high chemical resistance.
- Withstands temperature ranges from -40° to 160°F (-40° to 70°C).
- Meets Gastronorm GN food pan specifications EN-631-1.
- Non-stick smooth interior surface promotes easy cleaning.

Color: Translucent (190).
 Graduation marks and capacities are approximate.
 Translucent food pans are made of FDA approved materials.
 Translucent food pans interstack with other Cambro food pans.
 Translucent pans are not designed for steam table use.



Ideal for transporting in Cambro top loading carriers. (UPC100, UPCS140, 100MPC, UPC140, UPCS160, 240MPC, UPC160)



Seal covers protect food quality while eliminating the expense of plastic wrap. Available for all Camwear® and translucent food pan sizes.



Uniform 1/2" (1,27 cm) flange width ensures the right fit in prep tables and food bars.



Use Cambro StoreSafe® food rotation labels on translucent food pans to manage inventory and reduce waste.

TRANSLUCENT COLANDER PANS

- Rinse, drain and store all in one pan.
- Liquids drain easily into the food pan below for enhanced food quality and reduced handling.
- Translucent Cover w/Handle and Notched Cover with Handle fit on pans with colanders.

Color: Translucent (190).
 Translucent food pans are made of FDA approved materials.
 Translucent pans are not designed for steam table use.



CONFIGURATIONS	PAN CODE	COLANDER DEPTH	FITS TRANSLUCENT PAN DEPTH	LIST PRICE EA.
GN 1/3 6 ¹⁵ / ₁₆ " x 12 ³ / ₄ " (17,6 x 32,5 cm)	33CLRPP	3" (7,6 cm)	4" (10 cm)	\$ 8.30
	35CLRPP	5" (12,7)	6" (15)	9.60
GN 1/6 6 ³ / ₈ " x 6 ¹⁵ / ₁₆ " (16,2 x 17,6 cm)	63CLRPP	3" (7,6)	4" (10)	5.35
	65CLRPP	5" (12,7)	6" (15)	6.05

Case Pack for all Pans: 6. Lids listed on following page. **Color:** Translucent (190).

TRANSLUCENT FOOD PANS AND LIDS



FULL SIZE

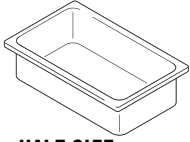

CONFIGURATIONS	PAN CODE	PAN DEPTH	APPROXIMATE CAPACITY	LIST PRICE EA.
GN 1/1 12 ³ / ₄ " x 20 ⁷ / ₈ " (32,5 x 53 cm)	14PP	4" (10 cm)	13.7 qt.	\$ 16.80
	16PP	6" (15)	20.6	21.50
	18PP	8" (20)	27	28.90
	10PPD	—	Drain shelf	9.55

HALF SIZE

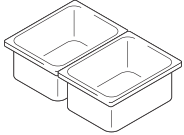

GN 1/2 10 ⁷ / ₁₆ " x 12 ³ / ₄ " (26,5 x 32,5 cm)	24PP	4" (10)	6.3	10.05
	26PP	6" (15)	9.4	13.05
	20PPD	—	Drain shelf	4.95

ONE THIRD SIZE

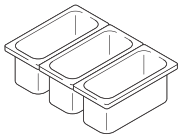

GN 1/3 6 ¹⁵ / ₁₆ " x 12 ³ / ₄ " (17,6 x 32,5 cm)	32PP	2 ¹ / ₂ " (6,5)	2.5	6.10
	34PP	4" (10)	3.8	8.30
	36PP	6" (15)	5.6	9.60
	30PPD	—	Drain shelf	4.60

QUARTER SIZE

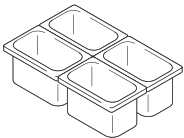

GN 1/4 6 ³ / ₈ " x 10 ⁷ / ₁₆ " (16,2 x 26,5 cm)	42PP	2 ¹ / ₂ " (6,5)	1.8	6.10
	44PP	4" (10)	2.7	7.20
	46PP	6" (15)	3.9	8.30
	40PPD	—	Drain shelf	3.85

ONE SIXTH SIZE

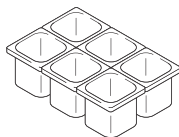

GN 1/6 6 ³ / ₈ " x 6 ¹⁵ / ₁₆ " (16,2 x 17,6 cm)	62PP	2 ¹ / ₂ " (6,5)	1.1	4.70
	64PP	4" (10)	1.6	5.35
	66PP	6" (15)	2.4	7.00
	60PPD	—	Drain shelf	2.55

ONE NINTH SIZE

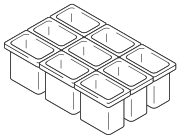

GN 1/9 4 ¹ / ₄ " x 6 ¹⁵ / ₁₆ " (10,8 x 17,6 cm)	92PP	2 ¹ / ₂ " (6,5)	0.6	4.95
	94PP	4" (10)	0.9	6.05
	90PPD	—	Drain shelf	1.75

Case Pack: 6 Color/InStock Color: Translucent (190).

Color: Translucent (190).

All translucent food pans are made of FDA approved materials.

All translucent polypropylene GN Food Pans are designed to CEN Gastronorm Standard EN 631-1.



Drain Shelf

Available for all food pan sizes.



Cover with Handle

Available for all food pan sizes except 1/9.



Notched Cover with Handle

Available for 1/3 and 1/6 food pans.



Seal Cover

Available for all food pan sizes.



Flat Cover

Only available for 1/9 food pans.



1/1



1/3



1/4



1/6

FITS PAN	LID CODE	DESCRIPTION	LIST PRICE EA.
GN 1/1 12 ³ / ₄ " x 20 ⁷ / ₈ " (32,5 x 53 cm)	10PPCH	Cover with handle	\$ 12.45
	10PPCWSC	Seal cover	11.95

GN 1/2 10 ⁷ / ₁₆ " x 12 ³ / ₄ " (26,5 x 32,5 cm)	20PPCH	Cover with handle	8.55
	20PPCWSC	Seal cover	7.30

GN 1/3 6 ¹⁵ / ₁₆ " x 12 ³ / ₄ " (17,6 x 32,5 cm)	30PPCH	Cover with handle	5.90
	30PPCHN	Notched cover w/handle	7.30
	30PPCWSC	Seal cover	5.50

GN 1/4 6 ³ / ₈ " x 10 ⁷ / ₁₆ " (16,2 x 26,5 cm)	40PPCH	Cover with handle	5.75
	40PPCWSC	Seal cover	4.85

GN 1/6 6 ³ / ₈ " x 6 ¹⁵ / ₁₆ " (16,2 x 17,6 cm)	60PPCH	Cover with handle	5.00
	60PPCHN	Notched cover w/handle	5.45
	60PPCWSC	Seal cover	3.75

GN 1/9 4 ¹ / ₄ " x 6 ¹⁵ / ₁₆ " (10,8 x 17,6 cm)	90PPC	Flat cover	4.30
	90PPCWSC	Seal cover	3.35

Case Pack: 6 Color/InStock Color: Translucent (190).

COLDVEST® GASTRONORM PANS, CROCKS, COVERS & PUMPS



- Keeps contents chilled at or below HACCP guidelines of 41°F (4°C) without the use of messy ice.
- Freeze upside down for eight hours or overnight before filling with pre-chilled product.
- Half and third-size pans hold contents cold for up to eight hours. Sixth size pans and crocks hold contents cold for up to six hours.
- Conforms to Gastronorm exterior dimensions to fit standard food bars or make tables.
- Stackable to save space when freezing and storing.
- Can be used for direct food contact with all types of food products.

Colors: Black (110), White (148).
Flat Cover Color: Clear (135).
Seal Cover Color: White (148).
Pump with Cover Color: Clear (135).

Suggested holding times are based on tests with ambient room conditions of up to 74°F (23°C).

ColdFest is covered under U.S. Patent D 419,364.

*Pumps and Round Covers are Not NSF Listed.



Ideal in Cambro Salad Bars or to keep condiments and creamers chilled.

Pans / Crock



CODE	26CF	36CF	66CF	CFR18
CONFIGURATIONS	GN 1/2 – 10¼" x 12¾"	GN 1/3 – 6 ¹¹ / ₁₆ " x 12¾"	GN 1/6 – 6 ³ / ₈ " x 6¾"	Dia. 6 ¹³ / ₁₆ "
DEPTH	6"	6"	6"	6¾"
APPROX. CAPACITY	6.5 qt.	3.7 qt.	1.5 qt.	1.7 qt.
LIST PRICE EACH	\$ 59.85	\$ 45.00	\$ 30.65	\$ 33.25

Case Pack: 1 InStock Color: White (148).



ColdFest Food Pans are made with high-impact resistant ABS shells and non-toxic refrigerant gel cores.

Covers



CODE	20CFC	30CFC	60CFC	CFRC18*	CFRSC18
DESCRIPTION	Flat cover	Flat cover	Flat cover	Flat cover	Seal cover
FITS COLDVEST	GN 1/2	GN 1/3	GN 1/6	Crock	Crock
LIST PRICE EACH	\$ 15.15	\$ 12.65	\$ 6.75	\$ 18.50	\$ 5.50

Case Pack: 2 InStock Color: Clear (135).

Pumps with Covers



CODE	CFPSRC10*	CFPMRC10*	CFPFR10*
DESCRIPTION	Standard pump dispense 1oz. portions	Maxi pump for chunky condiments	Fixed nozzle pump for controlled dispensing
DIMENSIONS W x D x H	7¼" x 9" x 11¼"	7¼" x 10¼" x 12 ³ / ₈ "	7¼" x 11 ⁵ / ₈ " x 11¼"
LIST PRICE EACH	\$ 15.90	\$ 37.85	\$ 37.50

Case Pack: 1



PIZZA DOUGH BOXES AND PIZZA DOUGH BOX CAMDOLLY



DB18263P

Polypropylene

- Ideal for storing, transporting, proofing and cooling dough.
- Lightweight, durable, and break resistant.
- Chemical resistant material won't absorb odors and is easy to clean.
- Boxes nest tightly together to keep out dirt and contaminants, extending product freshness.

- Each box acts as a tight lid for the box below, reducing the need and expense of covers.
- Withstands temperatures from -40° to 160°F.*
- Cover can be used as an 18" x 26" tray.

Color: White (148).

Camwear & Polypropylene dough boxes do not inter stack.

*Polypropylene dough boxes are safe for use in high temperature dishwashers.

Caster Type A: 5" Casters: 2 fixed, 2 swivel, 1 with brake.



CD1826PDB

Capacity: 300 lbs.
Caster Type: A
Holds: DB18263CW, DB18266CW, DB18263P



Camwear®

- Prevents crusting to increase the storage life of dough.
- Virtually unbreakable Camwear construction is reinforced on all sides.
- Boxes won't bend or lose their shape.

- Withstands temperatures from -40° to 210°F.
- Available in 3" and 6" depths.



DB18266CW

DB18263CW

CODE	OUTSIDE DIMENSIONS INSIDE DIMENSIONS	CASE PACK	LIST PRICE EA.
Polypropylene Pizza Dough Box			
DB18263P	18" x 26" x 3" 16" x 24"	6	\$ 39.40
Polypropylene Cover			
DBC1826P	18" x 26"	6	26.50
Camwear Pizza Dough Boxes			
DB18263CW	18" x 26" x 3" 16" x 24"	6	49.25
DB18266CW	18" x 26" x 6" 16" x 24"	6	66.20
Camwear Cover			
DBC1826CW	18" x 26"	6	35.90
Camdolly® For Pizza Dough Boxes			
CD1826PDB**	19 ⁷ / ₁₆ " x 27 ⁷ / ₁₆ " x 10 ¹ / ₄ " 17 ¹ / ₁₆ " x 25 ³ / ₈ "	1	365.00

InStock Color: White (148). **Optional Strap Available. See Camdolly section for available colors.

INGREDIENT BINS & CAMCRISPER®



Ingredient Bins

- Store bulk dry ingredients such as flour and grain.
- Hygienic clear sliding lid reduces handling and allows for quick content identification.
- Bin made of FDA-accepted material so no liners are needed.
- Designed to fit under standard work tables.

Camcrisper

- A self-contained system for brining or storing, washing and transporting bulk produce.
- Prevents cross contamination and minimizes unnecessary handling.
- Transfer dry produce out of cartons into bin, cover and roll into cooler for safe storage.
- Wash and rinse produce for easy and safe prep.

Soak and Brine Tank

- Designed for complete submersion of meats or poultry in brining solution for enhanced moisture retention, texture and flavor.
- Can also be used as a pre-soak tank for smallwares and dishes in sanitation solution to help reduce labor in pre-scrubbing.
- Clear sliding lid always stays on to help reduce the risk of cross-contamination.

3" Casters: 2 fixed, 2 swivel.

Bin Color: White (148).
Cover Color: Clear (135).

Scoops sold separately. S-Hook included.



Casters feature wide wheels for excellent stability and weight bearing capability.



Now with Sliding Lid.

CODE	IBS20	IBS27	IBS37	IBSF27
DIMENSIONS W x L x H	13" x 29½" x 28"	16⅝" x 29⅝" x 28"	21½" x 29½" x 28¼"	13" x 30⅝" x 28½"
CAPACITY	21 gal.	27 gal.	37 gal.	26.7 gal.
CUBIC FEET	2.87	3.98	5.55	3.56
LOAD CAPACITY (SUGAR)	170 lbs.	226 lbs.	314 lbs.	216 lbs.
LOAD CAPACITY (FLOUR)	140 lbs.	150 lbs.	225 lbs.	150 lbs.
LIST PRICE EACH	\$ 375.00	\$ 385.00	\$ 425.00	\$ 400.00

Case Pack: 1 InStock Color: White (148).



Camcrisper

Soak and Brine Tank

CODE	IB32	IB36	IB44	CC32	IBSD37
DIMENSIONS W x L x H	22" x 24" x 23"	15¼" x 29½" x 29"	18½" x 29½" x 29"	22" x 24" x 23"	21½" x 29½" x 28¼"
CAPACITY	32 gal.	34 gal.	42.5 gal.	32 gal.	37 gal.
CUBIC FEET	4.35	4.54	5.69	4.28	5.55
LOAD CAPACITY (SUGAR)	215 lbs.	252 lbs.	320 lbs.	24 lettuce heads (unfinished)	—
LOAD CAPACITY (FLOUR)	160 lbs.	180 lbs.	230 lbs.	42 lettuce heads (finished)	—
LIST PRICE EACH	\$ 415.00	\$ 425.00	\$ 430.00	\$ 620.00	\$ 566.67

Case Pack: 1

CAMWEAR® SCOOPS & MEASURING CUPS



Camwear Scoops

Color: Clear (135).

- Virtually unbreakable Camwear will not dent, chip or rust.
- Molded-in sure grip handle includes a hole for hanging.
- Ideal for use with Cambro Ice Caddies and Ingredient Bins.



CODE	APPROX. CAPACITY	CASE PACK	LIST PRICE EA.
SCP6CW	6 oz.	12	\$ 6.70
SCP12CW	12	12	7.25
SCP24CW	24	12	9.20
SCP64CW	64	6	13.10

InStock Color: Clear (135).

Camwear Measuring Cups

Color: Clear (135).

- Externally marked graduations are molded in and imprinted in red for American standard and blue for metric for easy measurement.
- Durable, virtually unbreakable Camwear will not dent, ensuring an accurate measurement every time.
- Molded-in handle will not break off.



CODE	CAPACITY	CASE PACK	LIST PRICE EA.
25MCCW	1 cup (dry measure)	12	\$ 6.55
50MCCW	1 pt.	12	12.20
100MCCW	1 qt.	12	13.70
200MCCW	2	12	18.90
400MCCW	4	1	20.50

InStock Color: Clear (135).

ALLERGEN MANAGEMENT

Storage Containers

- Personalized containers include easy-to-identify purple graduations and Allergen-Free imprint on the opposite side.
- Purple Seal covers feature an inner and outer seal to help keep ingredients safe from cross-contamination, even during transport.



Allergen 6 qt. Container: 6SFSCW441
Lid: SFC6SCPP441

Trays

- Protect your customers from the risk of allergenic foods by keeping color coded Allergen-Free trays on hand.



1418 Camtray
551 (Grape)

Measuring Cups

- Externally marked purple graduations and Allergen-Free logo are imprinted in Allergen purple for easy identification.



100MCCW441

CODE	DESCRIPTION	CAPACITY	CASE PACK	LIST PRICE EA.
Allergen-Free CamSquares®				
2SFSCW441	—	2 qt.	6	\$ 9.40
4SFSCW441	—	4	6	14.35
6SFSCW441	—	6	6	18.60
8SFSCW441	—	8	6	21.85
12SFSCW441	—	12	6	29.10
18SFSCW441	—	18	6	43.20
22SFSCW441	—	22	6	54.75
Allergen-Free CamSquare Seal Covers				
SFC2SCPP441	Fits 2 & 4 qt.	—	6	3.80
SFC6SCPP441	Fits 6 & 8	—	6	4.75
SFC12SCPP441	Fits 12, 18 & 22	—	6	6.90
Allergen-Free Trays				
1418	13 ¹⁵ / ₁₆ " x 17 ¹⁵ / ₁₆ "	—	12	24.95
Allergen-Free Measuring Cups				
25MCCW441	—	1 Cup (dry measure)	12	7.20
50MCCW441	—	1 pt.	12	13.40
100MCCW441	—	1 qt.	12	15.05
200MCCW441	—	2	12	20.80
400MCCW441	—	4	1	22.85

Color: Allergen-Free Purple (441).



TABLE SERVICE

Versa Camcovers®

Camwear® Camcovers

Camwear Dinnerware

CamView® Pitchers

Aliso® Barware, Goblets and Dessert Glass

Cambro Tumblers and Disposable CamLids®

CamView Camliters®

Beverage Dispenser, Pail with Bail and Swirl Bowls®

Camwear Wine Buckets, Punch Bowls and Bud Vase

Personalization



VERSA CAMCOVERS®

Serve hot food hot with the Versa Camcover, an elegant and efficient alternative to traditional metal covers.

- Withstands temperatures up to 300°F (149°C). *Can be used in heated carts.
- Covers remain cool to the touch for easy handling.
- Lighter and quieter than metal covers.
- Elegant appearance without polishing.
- Keeps food warm longer than metal covers.

- Available in a variety of sizes in round and square.
- Made of fiberglass material.

Colors: Ivory (380), Granite Gray (191), Antique Parchment (101).

*Microwave safe.

For help selecting the correct size plate cover, refer to the Camcover Sizing Guide on our website at www.cambro.com. Or, send one of your plates to Cambro Customer Service for sizing.



CODE	INSIDE DIAMETER	OUTSIDE HEIGHT	LIST PRICE EA.
Square			
85SFVS	8 ⁵ / ₈ "	2 ³ / ₄ "	\$ 13.40
978SFVS	10"	2 ³ / ₄ "	13.65
Round			
68VS	6 ¹ / ₂ "	2 ³ / ₁₆ "	11.35
86VS	8 ¹ / ₄ "	2 ⁵ / ₈ "	12.55
91VS	9 ¹ / ₈ "	2 ¹ / ₁₆ "	13.40
913VS	9 ¹³ / ₁₆ "	2 ¹ / ₁₆ "	13.40
95VS	9 ⁵ / ₁₆ "	2 ¹ / ₁₆ "	13.40
99VS	9 ⁹ / ₁₆ "	2 ⁵ / ₈ "	13.40
911VS	9 ¹¹ / ₁₆ "	2 ³ / ₄ "	13.80
100VS	10"	2 ¹ / ₁₆ "	13.65
103VS	10 ³ / ₁₆ "	2 ¹ / ₁₆ "	14.05
105VS	10 ⁵ / ₁₆ "	2 ¹ / ₁₆ "	14.05
106VS	10 ¹³ / ₃₂ "	2 ¹³ / ₁₆ "	15.75
1010VS	10 ⁵ / ₈ "	2 ¹ / ₁₆ "	14.90
1012VS	10 ³ / ₄ "	2 ¹ / ₁₆ "	14.90
1014VS	10 ⁷ / ₈ "	2 ¹ / ₁₆ "	14.90
116VS	11 ³ / ₈ "	3 ³ / ₁₆ "	16.05
120VS	12"	2 ⁷ / ₈ "	20.60
124VS	12 ¹ / ₄ "	2 ⁷ / ₈ "	21.35

Case Pack: 12

CAMWEAR® CAMCOVERS

- Food stays hot and appetizing without re-heating.
- Ideal for use in heated carts up to 210°F (99°C).*
- Made of durable Camwear, will not dent or scratch.
- Lightweight for quiet service.
- Saves on labor with no polishing required.

Colors: Clear (135), Amber (153), Beige (133), Silver (486).

MDCPC9CW Colors: Clear (135), Amber (153), Beige (133), Silver (486).

For help selecting the correct size plate cover, refer to the Camcover Sizing Guide on our website at www.cambro.com. Or, send one of your plates to Cambro Customer Service for sizing.

*Not recommended for microwave use.



CODE	INSIDE DIAMETER	OUTSIDE HEIGHT	LIST PRICE EA.
Camwear Camcovers			
806CW	8 ¹ / ₁₆ "	2 ¹ / ₁₆ "	\$ 9.75
900CW	9 ¹ / ₈ "	2 ³ / ₄ "	9.85
901CW	9 ³ / ₁₆ "	2 ¹³ / ₁₆ "	10.50
905CW	9 ¹ / ₂ "	2 ¹³ / ₁₆ "	10.80
909CW	9 ³ / ₄ "	2 ³ / ₄ "	10.75
9011CW	10"	2 ⁷ / ₈ "	11.70
9013CW	10"	2 ³ / ₄ "	11.70
1000CW	10 ³ / ₁₆ "	2 ¹ / ₁₆ "	11.65
1005CW	10 ⁵ / ₁₆ "	2 ¹³ / ₁₆ "	11.90
1007CW	10 ⁷ / ₁₆ "	2 ³ / ₄ "	11.90
1013CW	10 ¹³ / ₁₆ "	2 ¹ / ₁₆ "	11.95
1101CW	11"	2 ¹ / ₁₆ "	11.90
1202CW	12 ¹ / ₂ "	2 ³ / ₄ "	11.95

Camwear Low Profile Camcover

MDCPC9CW New!	9 ¹ / ₈ "	2"	8.75
----------------------	---------------------------------	----	------

Case Pack: 12

CAMWEAR® DINNERWARE

5 5 YEAR PRORATED WARRANTY
AGAINST BREAKAGE

- Durable Camwear resists stains, odors and scratches.
- Textured surface on salad and dinner plates for long wear.
- Ideal for schools, cafeterias, day care centers and healthcare facilities.
- Mug and stacking cup can be personalized.

Not recommended for microwave use.



Oval Platters and Compartment Plates



CODE	90SPCW	120CWP	93CW	HK93BCW*
DIAMETER	9" x 1 ¹⁵ / ₁₆ "	12" x 9"	9"	9 ¹ / ₂ "
DESCRIPTION	Round, soup bowl	Oval, narrow rim	Narrow rim	Heat Keeper base
CASE PACK	48	24	48	12
LIST PRICE EACH	\$ 7.35	\$ 8.40	\$ 7.30	\$ 15.70

*HK93BCW is available in Beige (133) only. Not recommended for microwave use.

Plates



CODE	10CWNR	9CWNR	825CWNR	725CWNR	65CWNR	55CWNR
DIAMETER	10"	9"	8 ¹ / ₄ "	7 ¹ / ₄ "	6 ⁵ / ₁₆ "	5 ¹ / ₂ "
DESCRIPTION	Narrow rim	Narrow rim	Narrow rim	Narrow rim	Narrow rim	Narrow rim
CASE PACK	48	48	48	48	48	48
LIST PRICE EACH	\$ 6.90	\$ 5.00	\$ 5.20	\$ 4.45	\$ 3.25	\$ 2.75

Not recommended for microwave use.

Bowls



CODE	10CW	10CWL	35CW	45CW	50CW	60CW	100CW	150CW
APPROX. CAPACITY	9.4 oz.	—	8.4 oz.	5 oz.	15.3 oz.	10.9 oz.	12.5 oz.	16.7 oz.
DESCRIPTION	Square bowl	Lid for 10CW bowl	Bouillon	#3 ¹ / ₂ Fruit cup	Nappie bowl	#1 Grapefruit bowl	5" Nappie	Square bowl
CASE PACK	48	48	48	48	48	48	48	48
SHAPE	Square	Square	Round	Round	Round	Round	Round	Top/Rnd-Bottom/Sqr
OUTSIDE DIA.	Top: 4" x 4"	—	3 ¹⁵ / ₁₆ "	4 ⁵ / ₈ "	5 ¹ / ₄ "	6"	5"	Top: 5 ¹ / ₄ "
HEIGHT	1 ¹ / ₈ "	7 ⁷ / ₈ "	2 ¹ / ₈ "	1 ¹⁵ / ₁₆ "	2 ¹ / ₈ "	1 ¹ / ₂ "	1 ¹¹ / ₁₆ "	2 ³ / ₈ "
LIST PRICE EACH	\$ 3.25	\$ 2.50	\$ 2.25	\$ 2.75	\$ 3.25	\$ 3.25	\$ 2.80	\$ 4.45

Not recommended for microwave use.

Mugs and Cups



CODE	75CW	96CW
APPROX. CAPACITY	7.5 oz.	9.6 oz.
DESCRIPTION	Stacking cup	Mug
CASE PACK	48	48
MAX DIA. / HEIGHT	4 ¹ / ₁₆ " - 3 ³ / ₁₆ "	4 ³ / ₁₆ " - 3 ³ / ₄ "
FULL SIZE CAMRACK®	16C414	16C414
LIST PRICE EACH	\$ 4.25	\$ 4.25

Maximum diameter includes handle.
Not recommended for microwave use.

Camwear® Heat Keepers



HK93PMC

CODE	HK93CW	HK39
DESCRIPTION	3 Compartment base and cover	Heat keeper base and cover for 9" plate
CASE PACK	6	6
LIST PRICE EACH	\$ 28.95	\$ 29.60

HK93CW is available in Beige (133). HK39 is available in Antique White (148).
Not recommended for microwave use.

Camcarrier® for HK93CW available by special request. Call Cambro Customer Service for more information.

CAMVIEW® PITCHERS

- Made of durable CamView material.
- Lightweight for easy handling.
- Exclusive ice-control contoured lip and pour spout reduce spills.
- Slotted base allows for complete and sanitary drying.

Color: Clear (135). P600CW is also available in Amber (153).

InStock Color: Clear (135).

Capacities calculated to rim.

PC34CW Stackable Pitcher is covered by the following U.S. Patent D 682,002 S.



P320CW, P480CW and P600CW

An industry standard. Broad base for stability, prevents tipping.



P320CW

CAPACITY: 32 oz.

HEIGHT WITH SPOUT: 6¾"

DIAMETER WITH HANDLE: 5¾"

LIST PRICE EACH: \$ 10.70

Case Pack: 6



P480CW

CAPACITY: 47 oz.

HEIGHT WITH SPOUT: 7⅞"

DIAMETER WITH HANDLE: 6¼"

LIST PRICE EACH: \$ 12.90

Case Pack: 6



P600CW - BPA FREE

CAPACITY: 60 oz.

HEIGHT WITH SPOUT: 8"

DIAMETER WITH HANDLE: 6¾"

LIST PRICE EACH: \$ 13.65

Case Pack: 6



P60CW

CAPACITY: 60 oz.

HEIGHT WITH SPOUT: 9"

DIAMETER WITH HANDLE: 7¼"

LIST PRICE EACH: \$ 15.75

Case Pack: 6

PL60CW

Laguna® pitcher with hammered texture that hides scratches. Pour liquids from front or ice and liquid from sides. Matching tumblers available.



PL60CW

CAPACITY: 60 oz.

HEIGHT WITH SPOUT: 7⅞"

DIAMETER WITH HANDLE: 6¾"

LIST PRICE EACH: \$ 9.35

Case Pack: 6

PE600CW

Economy and lightweight design. Pour liquids from front or ice and liquid from sides.



PE600CW

CAPACITY: 60 oz.

HEIGHT WITH SPOUT: 7⅞"

DIAMETER WITH HANDLE: 7⅞"

LIST PRICE EACH: \$ 9.35

Case Pack: 6

P64CW

Tapered design and drip-proof spout.



P64CW

CAPACITY: 64 oz.

HEIGHT WITH SPOUT: 9¼"

DIAMETER WITH HANDLE: 7⅞"

LIST PRICE EACH: \$ 15.75

Case Pack: 6

PC64CW

Three position lid can strain ice, free pour or close to protect contents.



PC64CW

CAPACITY: 64 oz.

HEIGHT WITH SPOUT: 9¼" with lid

DIAMETER WITH HANDLE: 7⅞"

LIST PRICE EACH: \$ 20.25

Case Pack: 6

PC34CW

Stackable pitchers and lid with frosted design to hide scratches.



PC34CW

CAPACITY: 34 oz.

HEIGHT WITH SPOUT: 7½" with lid

DIAMETER WITH HANDLE: 6⅞"

LIST PRICE EACH: \$ 9.50

Case Pack: 6

ALISO® BARWARE, GOBLETS AND DESSERT GLASS

Aliso Barware replicates the look, heft and clarity of glass with durable Camwear®. The smooth seamless appearance makes Aliso Barware a stylish choice for casual dining, outdoor events or poolside service.

- Barware items have large, heavy bases for stability.
- Bases designed for fast draining and complete drying.
- Chill or frost barware without concerns of thermal shock damage.

Color: Clear (135).

Capacities calculated to rim.



CODE	BWM10CW	BWW10CW	BWP14CW	BWB16CW	GB850CW	GB1200CW	DG3CW*
DESCRIPTION	Martini	Wine	Pilsner	Beer mug	Goblet	Goblet	Dessert glass
MAX DIAMETER	4 ¹³ / ₁₆ "	2 ¹⁵ / ₁₆ "	3 ¹ / ₄ "	4 ³ / ₄ "	2 ³ / ₄ "	2 ³ / ₄ "	2 ¹ / ₂ "
MAX HEIGHT	6 ⁷ / ₈ "	6 ³ / ₄ "	9 ⁹ / ₁₆ "	6 ¹ / ₄ "	6 ¹ / ₄ "	7 ⁷ / ₈ "	3"
FULL SIZE CAMRACK®	9S638	25S638	25S958	9S638	36S638	36S738	49S318
CAPACITY TO RIM	10.5 oz.	10.5 oz.	15.5 oz.	16 oz.	9 oz.	12.8 oz.	3.4 oz.
CASE PACK	12	24	24	12	24	24	72
LIST PRICE EACH	\$ 11.10	\$ 8.75	\$ 12.05	\$ 11.55	\$ 4.15	\$ 4.90	\$ 2.35

Color/InStock Color: Clear (135). * Cases only. No broken cartons.

CAMBRO® TUMBLERS AND DISPOSABLE CAMLIDS®



- Disposable lids fit tightly on Cambro tumblers, avoiding spills.
- Lids have tumbler code imprinted on them for easy cross reference.
- Includes a cross slot for straws.
- Reusable tumblers save operators the cost of replacing broken glass or disposable kids' cups while reducing waste.
- Reusable tumblers can be personalized with logos or exclusive designs to enhance branding.

CAMWEAR® *Durable*



TUMBLER	CAPACITY	LID
950CW	9.6 oz.	CLNT10
1600CW	17	CL900P

COLORWARE *Value Tumbler*



TUMBLER	CAPACITY	LID
500P/500P2	5.2 oz.	CLJ6
800P	7.8	CL800P
900P/900P2	9.7	CL900P
950P/950P2	9.8	CL950P

DEL MAR® *Crackled Glass Look*



TUMBLER	CAPACITY	LID
D14	14 oz.	CLST9

Disposable CamLid Color:

Translucent (190).

Disposable lids are sold in full cases only. No broken cartons.

*Excludes a cross-slot for straws.

LIDO® *Diamond Point Design*



TUMBLER	CAPACITY	LID
LDT5	5 oz.	CLJ6
LDT6	6	CLST6
LDT9	9	CL900P
LDT10	10	CLNT10
LDT12	12	CLNT12
LDT16	16	CLST9
LDT22	22	CLSM8B5*

HUNTINGTON® *Elegant Design, Durable*



TUMBLER	CAPACITY	LID
HT8CW	8 oz.	CLNT8
HT120CW	12	CLNT12
HT16CW	16	CLAM8B5*
HT22CW	22	CLSM8B5*

LAGUNA® *Hammered Texture*



TUMBLER	CAPACITY	LID
LT6	6 oz.	CLLT6
LT8	8	CLLT8
LT10	10	CLLT10
LT12	12	CLLT12
LT16	16	CLAM8B5*

NEWPORT *Traditional Fluted Design*



TUMBLER	CAPACITY	LID
NT5	6.5 oz.	CLNT5
NT8	8	CLNT8
NT9	9.3	CLNT9
NT10	10	CLNT10
NT12	12.6	CLNT12
NT20	22	CLSM8B5*

LIDO® TUMBLERS

- Ideal for fast-paced casual dining or outdoor events. Offers the look of glass without the risk.
- Easy to clean internal stacking ring promotes stable and space-efficient storage.
- Prevent spills with tight fitting disposable Camlids®.
- Made of impact resistant SAN plastic that resists chips and breaks, minimizing replacement costs.

Color: Clear (152).

Capacity is to the top fill-line.

Lido Tumblers are covered by U.S. Patent D720,963 S.



*6 oz. and 9 oz. tumblers feature subtle graduation markings intended for use in healthcare operations to measure liquid intake.



CODE	LDT5	LDT6	LDT9	LDT10	LDT12	LDT16	LDT22
FITS LID	CLJ6	CLST6	CL900P	CLNT10	CLNT12	CLST9	CLSM8B5**
DIAMETER	2 ⁵ / ₁₆ "	2 ¹ / ₁₆ "	3 ³ / ₁₆ "	2 ⁷ / ₈ "	3"	3 ⁵ / ₁₆ "	3 ¹ / ₂ "
HEIGHT	3 ¹ / ₁₆ "	3 ¹ / ₁₆ "	3 ¹ / ₁₆ "	4 ¹ / ₂ "	4 ¹⁵ / ₁₆ "	5 ⁵ / ₁₆ "	6 ⁷ / ₈ "
FULL SIZE CAMRACK®	49S318	36S318	25S318	36S418	30S434	25S534	20S638
CAPACITY TO RIM	5 oz.	6 oz.*	9 oz.*	10 oz.	12 oz.	16 oz.	22 oz.
LIST PRICE EACH	\$ 1.69	\$ 1.84	\$ 2.13	\$ 2.15	\$ 2.17	\$ 2.60	\$ 3.21

Case Pack: 36 **Excludes a cross-slot for straws.

CAMWEAR® HUNTINGTON® AND NEWPORT TUMBLERS

Huntington Tumblers

- Feature the elegant look and feel of glass without the high replacement costs.
- Made of durable Camwear.
- Lightweight.
- Stacking lugs to prevent sticking.
- Three sided drain bottom for easy washing and drying.

Colors: Azure Blue (196), Clear (135).

Capacities calculated to rim.

Withstands temperatures from -40° to 210°F.

*Excludes a cross-slot for straws.



CODE	HT5CW	HT8CW	HT10CW	HT120CW	HT12CW	HT14CW	HT16CW	HT22CW
MAX DIAMETER	2 ¹¹ / ₃₂ "	2 ¹¹ / ₁₆ "	2 ¹³ / ₁₆ "	3"	3 ³ / ₈ "	3 ¹ / ₄ "	3 ⁵ / ₁₆ "	3 ¹ / ₂ "
MAX HEIGHT	3 ⁹ / ₁₆ "	4 ⁷ / ₁₆ "	4 ¹³ / ₁₆ "	5"	3 ³ / ₄ "	4 ⁷ / ₈ "	5 ¹ / ₂ "	6 ¹¹ / ₁₆ "
FULL SIZE CAMRACK®	49S434	36S418	36S434	25S434	25S418	25S434	25S534	25S638
FITS LID	—	CLNT8	—	CLNT12	—	—	CLAM8B5*	CLSM8B5*
CAPACITY TO RIM	5 oz.	8 oz.	10 oz.	12 oz.	12 oz.	14 oz.	16 oz.	22 oz.
LIST PRICE EACH	\$ 2.58	\$ 2.70	\$ 2.81	\$ 2.94	\$ 2.88	\$ 3.23	\$ 3.76	\$ 4.70

Case Pack: 36 InStock Color: Clear (135).

Newport Tumblers

- Fluted design features the upscale look of glass with the safety benefits and cost savings of plastic.
- Impact resistant SAN plastic resists chips and breaks.
- Stacking lugs prevent sticking.
- Sani-Rim lip provides a sanitary drinking surface.

Colors: Clear (152), Amber (153), Slate Blue (401).

Capacities calculated to rim.

Withstands temperatures from -4° to 185°F.

*Excludes a cross-slot for straws.



CODE	NT5	NT8	NT9	NT10	NT12	NT14	NT16	NT20
MAX DIAMETER	2 ¹ / ₂ "	2 ¹¹ / ₁₆ "	3 ¹ / ₄ "	2 ¹³ / ₁₆ "	3"	3 ¹ / ₈ "	3 ¹ / ₄ "	3 ¹ / ₁₆ "
MAX HEIGHT	3 ¹¹ / ₁₆ "	4"	3 ⁹ / ₁₆ "	4 ⁷ / ₁₆ "	5 ¹ / ₈ "	5"	5 ³ / ₄ "	6 ¹ / ₂ "
FULL SIZE CAMRACK	36S318	36S418	25S318	36S434	25S434	25S434	25S534	25S638
FITS LID	CLNT5	CLNT8	CLNT9	CLNT10	CLNT12	—	—	CLSM8B5*
CAPACITY TO RIM	6.4 oz.	8 oz.	9.3 oz.	10 oz.	12.6 oz.	14 oz.	16.4 oz.	22 oz.
LIST PRICE EACH	\$ 1.54	\$ 1.60	\$ 1.74	\$ 1.90	\$ 1.97	\$ 2.29	\$ 2.36	\$ 2.92

Case Pack: 36 InStock Color: Clear (152).

LAGUNA® AND DEL MAR® TUMBLERS

Laguna Tumblers

- Hammered texture hides water spots and scratches.
- Made of impact resistant SAN.
- Lightweight and easy to carry.

Colors: Clear (152), Spanish Green (427).

Capacities calculated to rim.

Withstands temperatures from -4° to 185°F.

*Excludes a cross-slot for straws.



CODE	LT6	LT8	LT10	LT12	LT14	LT16	LT22
MAX DIAMETER	2½"	2¾"	2 ¹⁵ / ₁₆ "	3 ¹ / ₈ "	3 ¹ / ₄ "	3 ⁵ / ₁₆ "	3 ¹¹ / ₁₆ "
MAX HEIGHT	4¼"	4¼"	4¾"	5"	5 ¹ / ₈ "	5½"	6 ¹ / ₁₆ "
FULL SIZE CAMRACK®	36S418	36S418	30S434	25S434	25S434	25S534	16S534
FITS LID	CLLT6	CLLT8	CLLT10	CLLT12	—	CLAM8B5*	—
CAPACITY TO RIM	6 oz.	8 oz.	10 oz.	12 oz.	14 oz.	16 oz.	22 oz.
LIST PRICE EACH	\$ 1.93	\$ 2.11	\$ 2.18	\$ 2.39	\$ 2.53	\$ 2.80	\$ 3.15

Case Pack: 36 InStock Color: Clear (152).

Del Mar Tumblers

- Cracked glass look features the lightweight handling of plastic.
- Thick sturdy base and rolled rim edge for added stability.
- Made of impact resistant SAN plastic.

Colors: Clear (152), Ruby Red (156), Sapphire Blue (608), Light Amber (609).

Capacities calculated to rim.

Del Mar Tumblers are covered by the following U.S. Patent D 478,778 S.

Withstands temperatures from -4° to 185°F.



CODE	D8	D12	D14	D16	D24
MAX DIAMETER	2 ⁵ / ₈ "	2 ¹⁵ / ₁₆ "	3 ¹ / ₄ "	3 ¹ / ₁₆ "	3 ¹ / ₁₆ "
MAX HEIGHT	4 ³ / ₁₆ "	4¾"	4 ³ / ₁₆ "	5 ¹⁵ / ₁₆ "	6 ⁵ / ₈ "
FULL SIZE CAMRACK	36S418	25S434	25S418	25S534	25S638
FITS LID	—	—	CLST9	—	—
CAPACITY TO RIM	8 oz.	12 oz.	14 oz.	16 oz.	24 oz.
LIST PRICE EACH	\$ 1.48	\$ 1.56	\$ 1.93	\$ 1.98	\$ 2.57

Case Pack: 36 InStock Color: Clear (152).

COLORWARE TUMBLERS

- A classic value tumbler ideal for casual dining.
- Textured on the outside to resist scratching.
- Made of impact resistant SAN.
- Interior stacking lugs for easy storing.
- Sani-Rim lip provides a sanitary drinking surface.

Colors: Slate Blue (401), Clear (152), Amber (153), Ruby Red (156).

Capacities calculated to rim.

Withstands temperatures from -4° to 185°F.



CODE (72 PACK)	500P	800P	900P	950P	1200P	1600P	2000P	—
CODE (24 PACK)	500P2	800P2	900P2	950P2	1200P2	1600P2	2000P2	3200P2
MAX DIAMETER	2 1/4"	2 5/8"	3 3/16"	2 3/4"	2 15/16"	3 1/8"	3 3/8"	3 15/16"
MAX HEIGHT	3 5/8"	4"	3 3/4"	4 3/8"	5 3/16"	5 3/4"	6 1/2"	7 1/4"
FULL SIZE CAMRACK®	49S318	36S418	25S318	36S418	25S434	25S534	25S638	16S738
FITS LID	CLJ6	CL800P	CL900P	CL950P	—	—	—	—
CAPACITY TO RIM	5.2 oz.	7.8 oz.	9.7 oz.	9.8 oz.	12.6 oz.	16.4 oz.	22 oz.	32 oz.
P CODE-CASE PACK	72	72	72	72	72	72	72	—
P2 CODE-CASE PACK	24	24	24	24	24	24	24	24
LIST PRICE EACH - 72 PACK	\$ 1.02	\$ 1.23	\$ 2.07	\$ 1.43	\$ 1.59	\$ 1.88	\$ 2.32	—
LIST PRICE EACH - 24 PACK	\$ 1.09	\$ 1.32	\$ 2.26	\$ 1.55	\$ 1.68	\$ 1.99	\$ 2.53	\$ 3.77

InStock Color: Clear (152).

Camrack IceExpress Glass Filler

- Dramatically reduces banquet set-up time.
- Fills 25 glasses with ice all at once.
- Reduces breakage and risk of contamination.
- Ice falls directly into glasses with no spills or drips.

CODE	EXTERIOR DIMENSIONS W x D x H	LIST PRICE EA.
25SWGf	20" x 20 1/2" x 1 1/4"	\$ 88.25

Case Pack: 1 Color: Black (110).



Coca-Cola® Tumblers

- Colorware Tumblers featuring the Coca-Cola trademark logo in White.
- Available only to Coca-Cola fountain customers for foodservice use.

Color: Clear (152).

Coca-Cola Logo is imprinted in White only.

These trademarked tumblers may not be resold at retail and are available only for distribution to Coca-Cola Fountain customers for food service use.

Withstands temperatures from -4° to 185°F.



CODE	20CC	32CC
MAX DIAMETER	3 3/8"	3 15/16"
MAX HEIGHT	6 1/2"	7 1/4"
FULL SIZE CAMRACK	25S638	16S738
CAPACITY TO RIM	22 oz.	32 oz.
CASE PACK	72	24
LIST PRICE EACH - 72 PACK	\$ 2.74	—
LIST PRICE EACH - 24 PACK	—	\$ 4.13

CAMWEAR® TUMBLERS AND CAMVIEW® CAMLITERS®

Camwear Tumblers

- The look and feel of glass but made of durable Camwear.
- Textured exterior surface resists scratching.
- Smooth interior promotes easy cleaning.
- Designed with a Sani-Rim lip for sanitary drinking.

Color: Clear (152).

Capacities calculated to rim.

Withstands temperatures from -40° to 210°F.



CODE	500CW	800CW	850CW	950CW	1200CW	1600CW
MAX DIAMETER	2¼"	2⅝"	3⅜"	2¾"	2 ¹⁵ / ₁₆ "	3⅝"
MAX HEIGHT	3⅝"	3⅞"	3 ¹³ / ₁₆ "	4⅜"	5 ³ / ₁₆ "	5¾"
FULL SIZE CAMRACK®	49S318	36S418	25S418	36S418	25S434	25S534
FITS LID	—	—	—	CLNT10	—	CL900P
CAPACITY TO RIM	5.4 oz.	8 oz.	9.1 oz. (Heavy wall)	9.6 oz.	13 oz.	17 oz.
LIST PRICE EACH	\$ 1.55	\$ 1.90	\$ 4.85	\$ 2.20	\$ 2.50	\$ 3.10

Case Pack: 48

CamView Camlitter Beverage Decanters

- Ideal for serving juice or wine on buffet lines or table side.
- Spill-proof, snap tight flat lids included to protect content from cross contamination.
- Pour spout lid available to protect content while allowing free pour.

- Light-weight, dent and scratch resistant.
- Made of impact resistant material.
- NSF Listed- Camlitter with Flat Lid.

Color: Clear (135).

Lid Color: White (148).



Lids not NSF listed.

CODE	CAPACITY	HEIGHT	LIST PRICE EA.
Camlitters with Flat Lids			
WW1500	1½ L	10"	\$ 13.60
WW1000	1	9¾"	10.45
WW500	½	7⅞"	7.70
WW250	¼	6¼"	4.65

Lids

WW1000LS (Pour spout lid for 1½ L, 1 L and ½ L)	0.95
WW1000L (Replacement lid for 1½ L, 1 L and ½ L)	0.95
WW250L (Replacement lid for ¼ L)	0.95

Case Pack: 12 InStock Color: Clear (135).



WW1000L - Flat Lid



WW1000LS - Pour Spout



BEVERAGE DISPENSER, PAIL WITH BAIL AND SWIRL BOWLS®



6-Gallon Beverage Dispenser

- Perfect for mixing and serving concentrated beverages.
- Standard and metric graduations are printed on dispenser.
- Impact resistant polyethylene withstands temperatures from -40° to 160°F (-40° to 70°C).

CODE	LIST PRICE EA.
DSPR6	\$ 47.15

Case Pack: 1 **Color:** White (148).
DSPR6 Capacity: 6 gallons (22,7 L).



Pail with Bail – Poly

- A large, multi-purpose, 22 quart (20,8 L) pail, ideal for mixing, storing and transporting.
- Durable polyethylene withstands temperatures from -40° to 160°F (-40° to 70°C), and is stain resistant.
- Snap-tight, thumb tab cover sold separately.

CODE	LIST PRICE EA.
PWB22	\$ 27.55
RFSC12 (cover)	5.15

Case Pack: 6 **Color:** White (148).
 All graduations are approximate.



Swirl Bowls

- Ideal for hot or cold side dishes, desserts, dips, or fruit.
- Fits on a plate or stacks in place on a buffet station.
- Available in durable Camwear® or break resistant SAN.

Colors:
SRB5CW and SRB13CW: Clear (135), Black (110), White (148).
SRB5 and SRB13: Clear (152), Black (110), White (148).

*Made of (P.E.T.) material.



SRB13CW

SRB5CW

Disposable lid available

CODE	CAPACITY	CASE PACK	LIST PRICE EA.
Camwear			
SRB5CW	5 oz.	24	\$ 2.25
SRB13CW	13	24	4.45
SAN			
SRB5	5	24	1.90
SRB13	13	24	3.55
Disposable Lid			
CLSRB5*	Fits 5 oz. only	1,000	146.45

Disposable Lid Color: Clear (152). **InStock Colors:** Clear (152).

CAMWEAR® WINE BUCKETS, PUNCH BOWLS AND BUD VASE

Wine Buckets

- Chill and showcase wine or champagne.
- Tough Camwear won't crack or break and is easy to clean.

Color: Clear (135).



WC100CW

CODE	SIZE DIA. x H	LIST PRICE EA.
WC100CW	8" x 9½"	\$ 40.95
WC100CWNH (without handles)	8" x 9"	23.55

Case Pack: 1

Pebbled Pedestal Punch Bowls

- Perfect for parties, weddings and receptions.
- Made of durable Camwear.
- Attractive pebbled exterior is scratch resistant and smooth interior is easy to clean.

Color: Pebbled (176).

Capacities are calculated to rim.



CODE	INSIDE DIAMETER	APPROX. CAPACITY	LIST PRICE EA.
PPB15	15"	11.2 qt.	\$ 74.40
PPB18	18"	20.2	98.15
PPB23	23"	40.0	168.85

Case Pack: 1

Bud Vase

- Ideal for dining rooms, cafeteria tables and patient or room service trays.
- Made of durable Camwear.
- Fill with a fresh rose bud or a colorful faux flower.

Colors: Black (110), Clear (135), White (148).



CODE	DESCRIPTION	LIST PRICE EA.
BV6CW	6" Bud vase	\$ 3.50

Case Pack: 12

PROMOTE YOUR BRAND

Personalize tumblers, barware, pitchers or other table service items with your logo or design. Use personalized drinkware in promotions.

Food storage products can also be personalized to identify menu items, add fill lines for recipes or to add instructions in multiple languages to help ensure product quality and consistency.

 Look for this icon that identifies items that can be personalized.

IMPRINTING TABLE SERVICE AND STORAGE ITEMS

Sample Turnaround Time: 7-10 business days after receipt of approved artwork

Print Area: 1/4" to 4", subject to printable area on each item

Full Case Quantity: No broken Cartons

PERSONALIZATION CHARGES (NET)

Sample Charge: \$ 50.00 (Charge will be billed on sample order, credited on first purchase order)

Plate Charge: \$ 75.00 (Billed on sample order, one time charge)

Set-Up Charge: \$ 50.00 (per order)

Cost Per Imprint: \$ 0.30 (per side)

HOW TO ORDER A SAMPLE

1. Request a Sample

Contact your local Cambro representative to complete and submit your sample request to Cambro.

2. Provide Artwork

Provide ready to use artwork, digital format only. Completed sample request form must be submitted to Cambro **PRIOR** to artwork being sent. If artwork is incomplete, graphic support services are available at \$ 50.00 per hour.

3. Submit Artwork

E-mail artwork to your Cambro Rep or direct to Cambro at letsgetpersonal@Cambro.com. Title e-mail subject with logo name and provide contact info.

File dimensions: 100% reproduction size, 300dpi resolution.

File type:

Adobe® Illustrator®, Photoshop®.

File format: jpeg, tiff, and eps.

Or mail digital artwork to:
Cambro Attn: Kristie Patterson,
7601 Clay Avenue,
Huntington Beach, CA 92648.

4. Questions

Call Kristie Patterson
at 714-230-4125 direct
or 800-854-7631 ext. 4125.

5. Sample Approval

A signed sample approval form must be faxed to Cambro customer service prior to processing any purchase orders. This form is included with each sample.



CHOOSE ANY ONE OF THESE STANDARD IMPRINT COLORS



Due to the catalog printing process, the colors shown may not be exact.



DISPLAY

Deli Crocks & Platter

Camwear® Bowls

Bell Shaped, Budget & Fiberglass Bowls

ShowFest® Display Bowls & Trays

Crocks And Ladles

Serving Spoons, Camtensils® & Turners

Lugano® Tongs

Camwear Shakers/Dredges

Condiment Jars

Camwear Display Covers & Trays



DELI CROCKS & PLATTER

- Prep, store and serve all in one with contemporary style at an economical price.
- Crock and platter are made of SAN, making them impact, stain and chip resistant.
- Ideal for supermarket delis, sandwich shops, buffets and catered events.
- Handled covers are made of crystal clear, virtually unbreakable Camwear®.

Crock and Platter Colors: Clear (152), Black (110), White (148), Red (404).

Crock Cover Color: Clear (135).

Deli Crock covers are covered by the following U.S. Patents D 504,283 S, D 503,871 S & D 494,419 S. Scalloped Food Service Cover is covered by the following U.S. Patent D 509,705 S.

DCC5, DCC10 are NSF Component.



Prep, stack, store and serve all in one.



Interstacking saves storage space.



Avoid cross contamination and keep food fresh by using clear cover with handle.



Lid can be used as a riser to provide additional height on the buffet table or in a deli display case.



Cover doubles as a false bottom for presentation and to reduce waste.

Crocks & Platter

CODE	DC5	DC10	DP15
DESCRIPTION	Crock	Crock	Platter
DIM. W x D x H	10 ⁵ / ₁₆ " x 6 ¹³ / ₁₆ " x 3 ³ / ₁₆ "	13 ³ / ₁₆ " x 10 ⁷ / ₁₆ " x 3 ³ / ₁₆ "	11 ⁵ / ₁₆ " x 15 ³ / ₄ " x 2 ³ / ₁₆ "
APPROX. CAPACITY	2.2 qt.	4.9 qt.	3.4 qt.
LIST PRICE EACH	\$ 11.35	\$ 15.60	\$ 13.35

Case Pack: 6



Covers



CODE	DCC5 fits DC5	DCC10 fits DC10
DIM. W x D x H	9 ³ / ₈ " x 5 ⁷ / ₈ " x 1 ¹ / ₁₆ "	12 ³ / ₁₆ " x 9 ⁷ / ₁₆ " x 1 ¹ / ₁₆ "
APPROX. CAPACITY	0.9 qt.	2 qt.
LIST PRICE EACH	\$ 7.95	\$ 11.10

Case Pack: 6

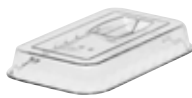

SHOWFEST® DISPLAY BOWLS & TRAYS

- Showcase cold deli, buffet and salad bar items.
- Made from SAN for impact, stain, break & chip resistance.
- Variety of shapes and sizes to make the best use of display area.

Color: Black (110).



Scalloped Ovals



CODE	SFV1015
DIM. W x L x H	10" x 15" x 2½"
APPROX. CAPACITY	3 qt.
LIST PRICE EACH	\$ 18.30
Case Pack: 6	



Scalloped Rectangles



CODE	SFR1012
DIM. W x L x H	10" x 12½" x 3"
APPROX. CAPACITY	4.5 qt.
LIST PRICE EACH	\$ 17.60
Case Pack: 6	

Octagonals



CODE	SFG1012	SFG1015	SFG820	SFG1220
DIM. W x L x H	10" x 12" x 2"	10" x 15" x 2"	8" x 20" x 2"	12" x 20" x 2"
APPROX. CAPACITY	3 qt.	3.5 qt.	4 qt.	6 qt.
LIST PRICE EACH	\$ 17.60	\$ 18.75	\$ 19.95	\$ 23.95
Case Pack: 6				

Triangles



CODE	SFT1010	SFT1212	SFT1515
DIM. W x L x H	10" x 10" x 12" x 2½"	12" x 12" x 15" x 2½"	15" x 15" x 20" x 2½"
APPROX. CAPACITY	2 qt.	3 qt.	4.5 qt.
LIST PRICE EACH	\$ 16.65	\$ 18.00	\$ 20.90
Case Pack: 6			





CAMWEAR® BOWLS

Round Pebbled Bowls

- Textured on the outside for an elegant look, smooth on the inside for easy cleaning.
- Made of virtually unbreakable Camwear for years of dependable service.
- Ideal for fruit, salads, snacks and desserts.

Color: Pebbled (176).

 Capacities are calculated to rim.

    CA PROP 65







Ribbed Bowls

- Stylish, contemporary appearance for a dramatic presentation.
- Made of virtually unbreakable Camwear that won't break like glass.
- Bowls are durable and lightweight. Will not chip and crack like acrylic.
- Resistant to stains, acids and odors.

Colors: Clear (135), Black (110), White (148).

 Rectangular Ribbed Bowls are not available in White (148).

 Capacities are calculated to rim.

    CA PROP 65



Round Pebbled Bowls



CODE	PSB6	PSB8	PSB10	PSB12
INSIDE DIAMETER	6"	8"	10"	12"
APPROX. CAPACITY	18.8 oz.	1.6 qt.	3.2 qt.	5.8 qt.
CASE PACK	12	12	12	12
LIST PRICE EACH	\$ 3.55	\$ 6.05	\$ 11.95	\$ 15.45

InStock Color: Pebbled (176).

CAMWEAR® BOWLS

Round Pebbled Bowls



CODE	PSB15	PSB18	PSB23
INSIDE DIAMETER	15"	18"	23"
APPROX. CAPACITY	11.2 qt.	20.2 qt.	40 qt.
CASE PACK	4	4	4
LIST PRICE EACH	\$ 25.15	\$ 40.05	\$ 61.00

InStock Color: Pebbled (176).

Rectangular Ribbed Bowls



CODE	RSB912CW	RSB1014CW	RSB1419CW
INSIDE DIAMETER	9" x 12 $\frac{1}{8}$ "	10 $\frac{3}{4}$ " x 14 $\frac{3}{16}$ "	14 $\frac{1}{4}$ " x 19 $\frac{3}{8}$ "
APPROX. CAPACITY	2.9 qt.	5 qt.	12 qt.
CASE PACK	12	4	4
LIST PRICE EACH	\$ 12.65	\$ 18.50	\$ 30.00

Rectangular Ribbed Bowls are not available in White (148).

Round Ribbed Bowls



CODE	RSB6CW	RSB8CW	RSB10CW	RSB12CW
INSIDE DIAMETER	6"	8"	10"	12"
APPROX. CAPACITY	18.8 oz.	1.65 qt.	3.2 qt.	5.8 qt.
CASE PACK	12	12	12	12
LIST PRICE EACH	\$ 4.55	\$ 8.85	\$ 16.20	\$ 27.00



CODE	RSB15CW	RSB18CW	RSB23CW
INSIDE DIAMETER	15"	18"	22 $\frac{7}{8}$ "
APPROX. CAPACITY	11.2 qt.	20.2 qt.	40 qt.
CASE PACK	4	4	4
LIST PRICE EACH	\$ 34.90	\$ 50.25	\$ 75.70

InStock Color: Black (110).

BELL-SHAPED, BUDGET & FIBERGLASS BOWLS

Camwear® Bell-Shaped Pebbled Bowls

- Perfect for showcasing fruits and salads.
- A versatile alternative to Cambro traditional Round Pebbled Bowls.
- Made from virtually unbreakable Camwear.

Color: Pebbled (176).

Capacities are calculated to rim.



CODE	BSB10	BSB12	BSB18
INSIDE DIAMETER	9 ¹ / ₈ "	12"	18"
APPROX. CAPACITY	2.1 qt.	4 qt.	12.5 qt.
CASE PACK	12	4	4
LIST PRICE EACH	\$ 11.95	\$ 15.40	\$ 32.45

Budget Salad Bowls

- An economical serving choice for fruit, salads, snacks and desserts.
- Impact resistant FDA approved material resists stains, acids and odors.

Colors: Birch (174), Black (110).

Capacities are calculated to rim.



CODE	SB55	SB60	SB80
INSIDE DIAMETER	5 ¹ / ₁₆ "	6"	8"
APPROX. CAPACITY	10.9 oz.	12.6 oz.	31.2 oz.
LIST PRICE EACH	\$ 1.90	\$ 2.30	\$ 4.65

Case Pack: 72



Fiberglass Bowls

- Combines the look of warm wood grains with the durability of fiberglass.
- Colors won't fade even after years of service and washing.

Color: Dark Basketweave (301).

Capacities are calculated to rim.



CODE	6F	8F
INSIDE DIAMETER	6 ¹ / ₈ "	8"
APPROX. CAPACITY	14.3 oz.	31.2 oz.
LIST PRICE EACH	\$ 12.25	\$ 14.25

Case Pack: 12



CROCKS AND LADLES

Crocks

- Ideal for use with salad bars, on buffet tables or at food stations.
- Resists stains and odors caused by vinegar, salad oils, or mayonnaise.
- Made of high impact FDA accepted material.
- Smooth surface is easy-to-clean.

Solid Color Crock Colors:
Black (110), Beige (133),
Reddish Brown (195), White (148).
Lid Color: White (148).
Clear Crock Color: Clear (152).

*Lids for Solid Color and Clear Crocks are not interchangeable.



CODE	CAPACITY	CASE PACK	LIST PRICE EA.
Solid Color Crocks			
CP12	1.2 quart w/lid	12	\$ 8.60
CP15	1.5 quart w/lid	6	10.65
CP27	2.7 quart w/lid	6	12.15
Lids for Solid Color Crocks			
CPL12*	Fits CP12 crock	12	1.45
CPL27*	Fits CP15 & CP27 crock	12	1.50
Clear Crocks			
CCP12	1.2 quart w/lid	12	9.85
CCP15	1.5 quart w/lid	6	15.40
CCP27	2.7 quart w/lid	6	16.40
Lids for Clear Crocks			
CCPL12*	Fits CCP12 crock	12	1.40
CCPL27*	Fits CCP15 & CCP27 crock	12	1.45

CODE	HEIGHT	TOP DIAMETER	CUT OUT DIAMETER
Solid Color Crock with Lid			
CP12	5 $\frac{5}{16}$ "	5 $\frac{1}{16}$ "	4 $\frac{3}{4}$ "
CP15	4 $\frac{5}{16}$ "	6 $\frac{5}{8}$ "	6 $\frac{3}{16}$ "
CP27	6 $\frac{3}{4}$ "	6 $\frac{5}{8}$ "	6 $\frac{1}{8}$ "
Clear Color Crock with Lid			
CCP12	5 $\frac{1}{4}$ "	5 $\frac{1}{4}$ "	4 $\frac{7}{8}$ "
CCP15	4 $\frac{3}{4}$ "	6 $\frac{3}{4}$ "	6 $\frac{1}{4}$ "
CCP27	6 $\frac{3}{4}$ "	6 $\frac{3}{4}$ "	6 $\frac{3}{16}$ "

InStock Color: Black (110).

Camwear® Ladles

- Portion control bowls serve the perfect amount of dressing or food ingredient.
- Angled for easy handling.
- Designed with a side rest so ladles don't slip into crocks or serving bowls.
- Made of virtually unbreakable Camwear for years of dependable service.

Colors: Black (110), Beige (133), Clear (135), White (148).

*Cambro's assortment pack is available in black only. It offers 8 imprinted ladles and 4 with no imprinting. The 8 imprints include: 1 Thousand Island, 1 French, 1 House, 1 Italian, 1 Bleu Cheese, 1 Ranch, 1 Low Cal, 1 Caesar. This makes a perfect start-up set for a salad bar.

Custom Order Ladle Imprints – See personalization section for information, ordering and pricing. Maximum imprint area is 1" x 1/2". Six dozen minimum.

No broken cartons on assortment pack or imprinted ladles. Special order item not carried in stock, non-returnable.



Imprinted Ladles shown.

CODE	DESCRIPTION	LENGTH	CAPACITY	LIST PRICE EA.
LD85	Plain	8 $\frac{1}{2}$ "	$\frac{3}{4}$ oz.	\$ 3.30
LD85A*	Assortment	8 $\frac{1}{2}$ "	$\frac{3}{4}$	4.75
LD105	Plain	10 $\frac{1}{16}$ "	1	3.30
LD105A*	Assortment	10 $\frac{1}{16}$ "	1	4.75
LD130	Plain	13"	1	3.70

Case Pack: 12 InStock Color: Black (110).

SERVING SPOONS, CAMTENSILS® & TURNERS

Camwear® Serving Spoons

- Made of virtually unbreakable Camwear, spoons won't tarnish, bend or dent.
- A wide handle and molded in thumb rest ensure a solid, ergonomic grip.
- Spoons feature a notched back to rest on pans.
- Spoon capacities are approximate and are not intended for measuring.

Colors: Black (110), Beige (133), Clear (135), White (148) Red (404).

InStock Color: Black (110).

*Cannot be personalized.



SPOP10CW PERFORATED
DESCRIPTION: ¾ oz. 10"
Perforated salad spoon
DIMENSIONS: 10¼" x 1¹¹/₁₆"
LIST PRICE EACH: \$ 2.85
Case Pack: 12



SPO11CW* PERFORATED
DESCRIPTION: 11"
Perforated deli spoon
DIMENSIONS: 11½" x 2⁷/₈"
LIST PRICE EACH: \$ 3.50
Case Pack: 12



SPOP13CW* PERFORATED
DESCRIPTION: 13"
Perforated deli spoon
DIMENSIONS: 13½" x 2⁷/₈"
LIST PRICE EACH: \$ 6.00
Case Pack: 12

See personalization section for information, ordering and pricing.



SPO8CW
DESCRIPTION: ½ oz. 8"
Salad spoon
DIMENSIONS: 8⁷/₈" x 1½"
LIST PRICE EACH: \$ 2.60
Case Pack: 12



SPO10CW
DESCRIPTION: ¾ oz. 10"
Buffet spoon
DIMENSIONS: 10¼" x 1¹¹/₁₆"
LIST PRICE EACH: \$ 2.85
Case Pack: 12



SPO11CW*
DESCRIPTION: 11"
Deli spoon
DIMENSIONS: 11½" x 2⁷/₈"
LIST PRICE EACH: \$ 3.50
Case Pack: 12



SP013CW*
DESCRIPTION: 13"
Deli spoon
DIMENSIONS: 13½" x 2⁷/₈"
LIST PRICE EACH: \$ 6.00
Case Pack: 12

High Heat Camtensils, Spoons and Turners

- Ideal for preparing and serving hot and cold foods.
- Made of a durable high heat material that withstands temperatures from -40° to 300°F (-40° to 149°C).
- Handle includes a hole for hanging when not in use and notches to rest on pans.

Colors: Amber (150), Black (110).

InStock Color: Black (110).



SP013
DESCRIPTION: 13"
Solid spoon
DIMENSIONS: 13½" x 2⁷/₈"
LIST PRICE EACH: \$ 10.90
Case Pack: 12



SPA14
DESCRIPTION: 14"
Solid turner
DIMENSIONS: 14½" x 3½"
LIST PRICE EACH: \$ 12.25
Case Pack: 12



SPOP13 PERFORATED
DESCRIPTION: 13"
Perforated spoon
DIMENSIONS: 13½" x 2⁷/₈"
LIST PRICE EACH: \$ 10.90
Case Pack: 12



SPASL14 SLOTTED
DESCRIPTION: 14"
Slotted turner
DIMENSIONS: 14½" x 3½"
LIST PRICE EACH: \$ 12.25
Case Pack: 12



LUGANO® TONGS

- Colored tongs are made from a durable heat resistant material. Temperature range of -40° to 212°F (-40° to 100°C).
- Clear tongs are made from virtually unbreakable Camwear®. Temperature range of -40° to 210°F (-40° to 99°C).

Lugano Flat and Scallop Grip Tongs

- Flat Tongs are ribbed to provide a secure hold.
- Scallop Tongs feature an ergonomic design and secure finger grip.

Colors: Black (110), Beige (133), Clear (135), Red (404), White (148).

InStock Color: Black (110).



FLAT GRIP



TGG6
LENGTH: 6"
LIST PRICE EACH: \$ 2.45
Case Pack: 12



TGG9
LENGTH: 9"
LIST PRICE EACH: \$ 3.90
Case Pack: 12

SCALLOP GRIP



6TGS
LENGTH: 6"
LIST PRICE EACH: \$ 2.50
Case Pack: 12



9TGS
LENGTH: 9"
LIST PRICE EACH: \$ 3.90
Case Pack: 12



12TGS
LENGTH: 12"
LIST PRICE EACH: \$ 5.90
Case Pack: 12



Lugano Angled and Easy-Grasp Tongs

- Angled tongs feature an ergonomic design that makes it easy to serve a variety of foods.
- Easy-Grasp Tongs provide a secure grip for hard to hold items.

Angled Tong Color: Black (110).

Easy-Grasp Tong Colors: Black (110), Beige (133), Clear (135), White (148).

InStock Color: Black (110).



ANGLED TONG



TGA8
LENGTH: 8¼"
LIST PRICE EACH: \$ 3.85
Case Pack: 12



TGA11
LENGTH: 10¹³/₁₆"
LIST PRICE EACH: \$ 4.50
Case Pack: 12

EASY-GRASP



TGG6
LENGTH: 6⁹/₁₆"
LIST PRICE EACH: \$ 3.85
Case Pack: 12



TGG9
LENGTH: 9½"
LIST PRICE EACH: \$ 4.15
Case Pack: 12



CAMWEAR® SHAKERS/DREDGES & CONDIMENT JARS

Camwear Shakers/Dredges

- A staple in the kitchen, at the condiment station or on the dining table.
- Clear virtually unbreakable Camwear and color coded lids make it easy to identify contents.
- Dishwasher safe and unaffected by food acids.

Shaker Color: Clear (135).



96SKRLD
Salt & Pepper



96SKRLM
Med. Ground



96SKRLC
Cheese



96SKRLP
Parsley

CODE	COLOR	APPROX. CAPACITY	LIST PRICE EA.
Shakers Complete with Lids			
96SKRP (w/parsley lid)	—	10	\$ 5.70
96SKRD (w/salt & pepper lid)	—	10	5.70
96SKRC (w/cheese lid)	—	10	5.70
96SKRM (w/medium ground lid)	—	10	5.70

InStock Color: Clear (135).



Lids

96SKRLP parsley lid	White (148)	—	0.95
96SKRLD salt & pepper lid	Beige (406)	—	0.95
96SKRLC cheese lid	Yellow (405)	—	0.95
96SKRLM medium ground lid	Rose (408)	—	0.95

Case Pack: 12

Camwear Condiment Jars

- Use to hold condiments such as mustard, ketchup, dressings, jam or salsa.
- Made of clear, virtually unbreakable Camwear.
- Lids are slotted to hold serving spoons when not in use.

Color: Clear (135).



CODE	APPROX. CAPACITY	SIZE H x D	CASE PACK	LIST PRICE EA.
Jar & Cover				
CJ80CW*	8 oz.	4" x 3¼"	24	\$ 8.25

*Spoons not included

CAMWEAR® DISPLAY COVERS & TRAYS

- Display covers protect freshness of pastries, breads and desserts.
- Virtually unbreakable Camwear features the upscale look of glass.
- Openings on side or end provide quick and easy access to contents without removing cover.**

Display Covers Color: Clear (135).

Display Trays Color: Clear (135), Black (110).



Display Trays are stackable.
Display Trays cannot be personalized.
Refer to Market Tray page for information.



RD1200CW



RD1220CW



RD1220CWH



**DD1220BECW



Display Tray – DT1220CW



**Dome with side cut – DD1220SCW

CODE	DESCRIPTION	APPROX. DIMENSIONS W x D x H*	CASE PACK	LIST PRICE EA.
Display Covers				
RD1200CW	Cake cover	12" x 12" x 8¼"	1	\$ 29.95
DD1220CW	Dome cover	21⅞" x 14¾" x 8"	1	51.75
DD1220ECW	Dome w/end cut	21⅞" x 14¾" x 8"	1	65.40
DD1220BECW	Dome w/2 ends cut	21⅞" x 14¾" x 8"	1	79.65
DD1220SCW	Dome w/side cut	21⅞" x 14¾" x 8"	1	65.40
DD1826CW	Dome cover	26¾" x 18⅞" x 8⅞"	1	72.60
RD926CW	Rectangular cover	26⅝" x 10" x 6¼"	1	48.20
RD1220CW	Rectangular cover	21⅞" x 14⅞" x 5⅝"	1	54.75
RD1220CWH	Rectangular w/hinge	21⅞" x 14⅞" x 5"	1	77.90
RD1826CW	Rectangular cover	26⅞" x 18⅞" x 6¼"	1	70.95
RD1826CWH	Rectangular w/hinge	26¾" x 18¾" x 5⅝"	1	82.80
Display Tray – Fits with all 1220 Covers				
DT1220CW	Tray	12" x 20"	1	20.85
Market Tray – Fits with all 1826 Covers				
1826MT	Tray	25⅜" x 17⅜" x 1⅜"	6	33.25

*Dimensions include handle(s). Handle height is 13/16".

TRAYS

Trays At A Glance

Personalized Camtrays®

Camtrays

Camtrays with Handles, Dietary Trays and
Metric Camtrays

Non-Skid Versa Camtrays

Non-Skid Versa Camtrays with Handles

Camwear® Trays

Camwear Non-Skid Trays

EpicTread™ Trays

Hotel Room Service Trays

Camtread® Trays

Treadlite™ Trays

Polytread® Trays

Personalized Camtread Trays

Fast Food Trays

Market Trays, Pans and Camlite® Trays

Compartment Trays

2 X 2 Compartment Trays

Compartment Serving Trays &
Trapezoid Compartment Trays

Meal Delivery Trays & Separator® Compartment Trays

Tray On Tray Meal Delivery System



TRAYS AT A GLANCE

Patron Trays

Camtray®

The industry standard. Durable fiberglass construction.



43 SIZES	8 SHAPES	53 COLORS
-------------	-------------	--------------



Non-Slip Service Trays

Camtread® Trays

Durable fiberglass construction with non-skid surface. Grips service items to avoid spills.



16 SIZES	3 SHAPES	2 COLORS
-------------	-------------	-------------



Camlite® Tray

Combine economy with durability. Fiberglass construction.



6 SIZES	1 SHAPE	9 COLORS
------------	------------	-------------



Treadlite™ Tray

Fiberglass reinforced polyester lightweight tray with molded in non-skid surface ensures items stay in place during service.



2 SIZES	1 SHAPE	2 COLORS
------------	------------	-------------



Camwear® Trays

Made of durable Camwear.



3 SIZES	3 SHAPES	5 COLORS
------------	-------------	-------------



Polytread® Trays

General purpose tray with non-skid surface.



6 SIZES	2 SHAPES	2 COLORS
------------	-------------	-------------



Fast Food Tray

Economical choice that withstands frequent use.



3 SIZES	1 SHAPE	14 COLORS
------------	------------	--------------



EpicTread™ Trays

Lightweight, contemporary tray with molded-in, non-skid surface.



2 SIZES	1 SHAPE	6 COLORS
------------	------------	-------------



Healthcare Dietary Tray

Low profile offers patient comfort. Made of durable fiberglass. Camtray and Non-Skid Versa Camtrays are also recommended for patient meal delivery.



6 SIZES	1 SHAPE	53 COLORS
------------	------------	--------------



Camwear Non-Skid Tray

Made of durable Camwear. Non-skid surface grips items firmly.



2 SIZES	2 SHAPE	3 COLORS
------------	------------	-------------



TRAYS AT A GLANCE

Non-Skid Versa Camtrays®

Non-Skid Versa Trays reduce waste, save money and provide a stable tray surface for meal delivery.



2 SIZES	3 SHAPES	3 COLORS
------------	-------------	-------------



Compartment Serving Trays

Compartment configurations to meet all menu requirements. Warranty varies by material.



3 SIZES	3 SHAPES	7 COLORS
------------	-------------	-------------



Service Trays

Hotel Room Service Tray

Lightweight yet durable service tray features a contemporary design.



1 SIZE	1 SHAPE	3 COLORS
-----------	------------	-------------



Trapezoid Compartment Tray

Offers seven deep compartments for ample, portion controlled serving.



1 SIZE	1 SHAPE	1 COLOR
-----------	------------	------------



Display Trays

Market Trays and Pans

Ideal for merchandising food items in showcases. Durable fiberglass construction.



19 SIZES	1 SHAPE	5 COLORS
-------------	------------	-------------



Separator® Compartment Trays

Tray with cover separates each compartment to retain food temperature and reduce spills. Warranty varies by material.



2 SIZES	1 SHAPE	4 COLORS
------------	------------	-------------



Compartment Trays

Compartment Tray

Six compartment tray available in three materials. Warranty varies by material.



1 SIZE	1 SHAPE	10 COLORS
-----------	------------	--------------



Tray on Tray Meal Delivery System

Use Insert Tray and Base Tray to serve hot and cold foods together. Warranty varies by material.



3 SIZES	2 SHAPES	4 COLORS
------------	-------------	-------------



2 x 2 Compartment Trays

Durable trays with easy grip handles. Trays fit side by side in dishrack to reduce warewashing expense. Warranty varies by material.



2 SIZES	2 SHAPES	9 COLORS
------------	-------------	-------------



Meal Delivery Trays

Deep compartments and snap-on cover. Warranty varies by material.

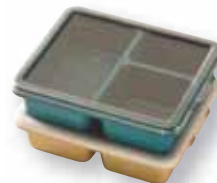

2 SIZES	2 SHAPES	4 COLORS
------------	-------------	-------------



PROMOTE YOUR BRAND — PERSONALIZED CAMTRAY®

Personalize Camtrays to display a message with every tray served. Advertise a product, promote your business, enhance patient satisfaction or strengthen school spirit.

 Look for this icon that identifies items that can be personalized.

CAMTRAYS

Digital Printing Process:

Allows printing of multiple color artwork as well as photo reproduction. This process can only be used on light color trays.

Printable Area:

The artwork can cover the flat surface of tray up to 1" from the internal tray edge.

Tray Order Minimum: 144

Silkscreen Printing Process:

Allows printing of artwork with one or multiple colors laying next to each other. This process is best used with light color artwork on dark color trays.

Printable Area:

The artwork can cover the total surface of the tray from one edge to the other.

Tray Order Minimum: 144

Personalization Charges Per Tray:

QUANTITY EACH	ADDITIONAL NET CHARGES
144-299	\$ 0.50
300 and up	Free



HOW TO ORDER A SAMPLE

1. Request a Sample

Contact your local Cambro representative to complete and submit the sample request form to Cambro.

2. Provide Artwork

Provide ready to use artwork, digital format only. Sample request form must be submitted to Cambro PRIOR to artwork being sent. If artwork is incomplete, graphic support services are available for \$50.00 per hour.

3. Submit Artwork

E-mail artwork to Cambro Rep or to Cambro at letsgetpersonal@Cambro.com. Title e-mail subject with logo name and provide contact info. **File dimensions:** 100% reproduction size, 300 dpi resolution.

File type:

Adobe® Illustrator®, Photoshop®.

File format: jpeg, tiff, and eps.

Or mail artwork on a CD-ROM to: Cambro Attn: Kristie Patterson, 7601 Clay Avenue, Huntington Beach, CA 92648.

4. Questions

Contact Kristie Patterson at 714-230-4125 direct or 800-854-7631 ext. 4125.

5. Sample Approval

A signed sample approval form must be faxed to Cambro customer service prior to processing any purchase orders. This form is included with each sample.

6. Sample Turnaround

7-10 business days.

* All personalized tray orders are full case quantities only; no broken cartons.

7. Personalization Charges (NET)

Tray Sample:

\$ 50.00 (Charge will be billed on sample order, credited on first purchase order.)

CAMTRAY®

- Use in restaurants, hotel room service, cafeterias, food courts, hospitals and schools.
- Durable construction backed by five year prorated warranty against manufacturer's defects.
- Made of lightweight, high-impact fiberglass.

- Stain and odor resistant.
- Stacking lugs keep trays stacked securely in place and ensure proper air flow.



Rectangular Camtrays

The industry standard.

Available in Group I colors and patterns and Group III Wood.

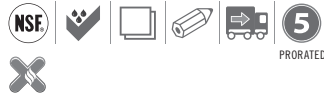

Trapezoid Camtrays

Saves tabletop space and increases seating capacity.

Available in Group I colors and patterns and Group III Wood.

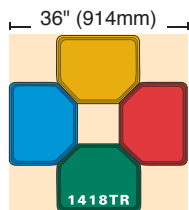
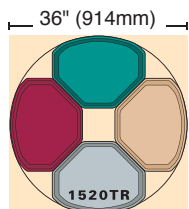
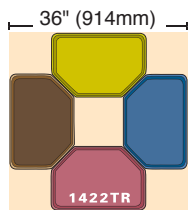
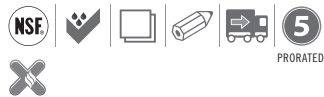

CODE	DIMENSIONS	CASE PACK	LIST PRICE EA.	
			GROUP I	GROUP III
Rectangular				
46	4¼" x 6"	12	\$ 5.10	\$ 7.10
57*	4 ¹⁵ / ₁₆ " x 6 ¹⁵ / ₁₆ "	12	5.50	7.70
810	8" x 9 ⁷ / ₈ "	12	12.15	15.70
915	8 ³ / ₄ " x 15"	12	17.25	20.00
926*	8 ⁷ / ₈ " x 25 ⁵ / ₁₆ " x 1"	12	22.55	29.20
1014	10 ⁵ / ₁₆ " x 13 ³ / ₄ "	12	16.00	20.70
1216	12" x 16 ⁵ / ₁₆ "	12	18.50	24.25
1318*	12 ⁵ / ₁₆ " x 17 ³ / ₄ " x 1 ¹ / ₁₆ "	12	22.95	28.65
1418	14" x 18"	12	22.10	28.80
1520	15" x 20 ¹ / ₄ "	12	26.70	34.65
1622	16" x 22"	12	30.75	40.00
16225*	16 ¹ / ₂ " x 22 ¹ / ₂ "	12	33.70	42.10
1826	17 ⁷ / ₈ " x 25 ³ / ₄ "	6	41.00	52.75
2025*	20 ³ / ₄ " x 25 ⁵ / ₁₆ "	6	50.00	60.85
Trapezoid				
1418TR	14" x 18"	12	20.95	28.30
1422TR*	14" x 22"	12	22.95	31.05
1520TR*	14 ⁹ / ₁₆ " x 19 ¹ / ₂ "	12	24.45	31.95

InStock Colors: Antique Parchment (101), Black (110). *Special order item not carried in stock, non-returnable. One case order minimum.

CAMTRAY®

Oval Camtrays

Perfect for banquet service.

Available in Group I colors and patterns (except Doily patterns) and Group III Wood.



Round Camtrays

A favorite for pizza and beverage service.

Available in Group I colors and patterns (except Doily patterns) and Group III Wood.

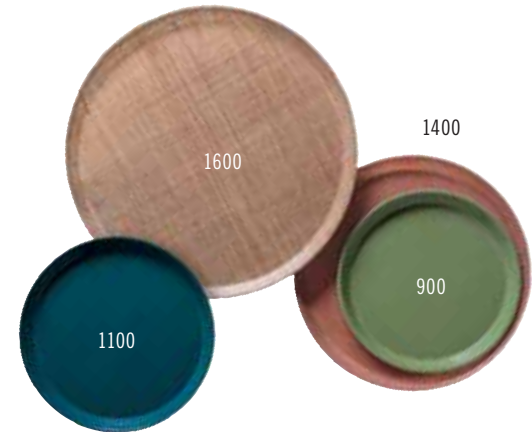

Insert Camtrays

Fits onto a Camtray to separate hot and cold food, ideal for dietary tray service.

Available in Group I colors and patterns (except Doily patterns) and Group III Wood.

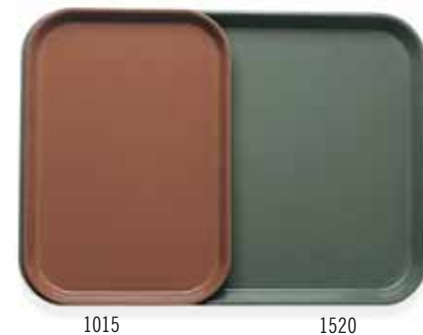
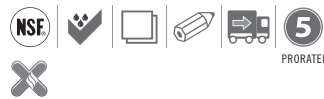

CODE	DIMENSIONS	CASE PACK	LIST PRICE EA.	
			GROUP I	GROUP III
Oval				
2500*	19 $\frac{1}{4}$ " x 24"	6	\$ 39.95	\$ 52.75
2700*	22" x 26 $\frac{1}{8}$ "	6	46.55	61.65
Round				
900*	9"	12	12.30	15.60
1000*	10"	12	13.60	17.65
1100	11"	12	13.60	17.20
1200*	12"	12	15.00	20.10
1300*	13"	12	16.55	21.85
1400	14"	12	16.85	22.85
1550*	16" low profile	12	21.55	28.10
1600	16"	12	21.15	28.30
1950*	19 $\frac{1}{2}$ " low profile	12	29.20	38.50
Insert				
1015* (2 trays fit into a 1520)	10 $\frac{3}{8}$ " x 15"	24	16.55	21.40
1116* (2 trays fit into a 1622)	10 $\frac{3}{8}$ " x 15 $\frac{1}{8}$ "	24	17.30	24.25

*Special order item not carried in stock, non-returnable.

CAMTRAYS® WITH HANDLES, DIETARY TRAYS AND METRIC CAMTRAY

Camtrays with Handles

- Enhance your tray presentation and improve your customer's experience with these easy-to-grip, ergonomic, contoured handles.
- Made of durable, lightweight and high-impact fiberglass.
- Stacking lugs keep trays stacked securely in place and ensure proper air flow.
- Dishwasher safe at high and low temperatures.

Available in Group I colors.
 Special order item not carried in stock, non-returnable. One case order minimum.
 NSF listed for non-direct food contact only.
 Personalization through digital printing process only. Please refer to Camtray Personalization section for details.
 Camtrays with handles is covered by U.S. Patent D 683,191 S.

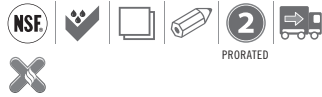

CODE	DIMENSIONS	LIST PRICE EA.
1418H	14" x 18"	\$ 25.00
1520H	15" x 20"	29.75

Case Pack: 12

Healthcare Dietary Trays

- Designed specifically for in-room patient feeding.
- Low slope edge provides easy access when dining from a hospital bed.
- Made of lightweight fiberglass.

Available in Group I colors and patterns and Group III Wood.



CODE	DIMENSIONS	CASE PACK	LIST PRICE EA.	
			GROUP I	GROUP III
Dietary				
1216D*	12" x 16"	12	\$ 19.10	\$ 25.35
1219D*	12" x 19"	12	22.45	29.00
1220D*	12" x 20"	12	24.30	31.20
1222D*	12" x 22"	12	24.30	31.15
1418D*	14" x 18"	12	22.25	29.40
1520D*	15" x 20 ³ / ₁₆ "	12	26.45	33.45

*Special order item not carried in stock, non-returnable.



Metric Camtrays

Designed to meet international specifications.

Available in Group I colors and patterns and Group III Wood. 3555TR is available in Group I colors and patterns except Doily.



CODE	DIMENSIONS	CASE PACK	LIST PRICE EA.	
			GROUP I	GROUP III
Metric				
1313*	13" x 13" (33 x 33 cm)	12	\$ 16.55	\$ 21.70

*Special order item not carried in stock, non-returnable.



1313

Other sizes available on www.cambro.com.

CAMTRAY® GROUP I COLORS

Colors listed alphabetically. See numerical reference on following page.

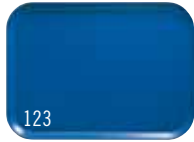

123
Amazon Blue



101
Antique Parchment



513
Bay Leaf Brown



110
Black



409
Blush



116
Brazil Brown



522
Burgundy Wine



521
Cambro Red



537
Cameo Yellow

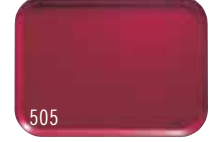

505
Cherry Red



220
Citrus Orange



538
Cottage White



117
Dark Peach



104
Desert Tan



514
Earthen Gold



221
Ever Red



551
Grape



105
Horizon Blue



429
Key Lime



536
Lemon Chiffon



106
Light Peach



113
Lime-ade



504
Mustard



428
Olive Green



222
Orange Pizzazz



107
Pearl Gray



410
Raspberry Cream



501
Real Rust



518
Robin Egg Blue



119
Sherwood Green



510
Signal Red



177
Sky Blue



401
Slate Blue



508
Suede Brown



199
Taupe



414
Teal



171
Tuscan Gold



148
White

Due to the catalog printing process, the colors & patterns shown may not be exact.
Contact Cambro or a Cambro representative for a color chip.

CAMTRAY® GROUP I PATTERNS

Galaxy

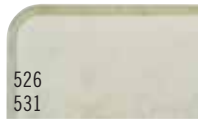

526
531
Antique Parchment
(526 Gold), (531 Silver)

Swirl



270
Black & Gold **NR**



277
Gray **NR**

Doily



241
Antique Parchment **NR**

Abstract



214
Tan **NR**



215
Gray **NR**

NR Trays are non-returnable.



CAMTRAY GROUP III WOOD

Wood



308
Burma Teak **NR**



304
Country Oak **NR**



301
Dark Basketweave **NR**



309
Java Teak **NR**

Linen



329
Toffee **NR**



302
Light Basketweave **NR**



303
Light Butcher Block **NR**



307
Light Elm **NR**



204
Rattan **NR**

NR Trays are non-returnable.

CAMTRAY GROUP I COLORS – NUMERICAL REFERENCE BY COLOR CODE

Antique Parchment (101),
Desert Tan (104), Horizon Blue (105),
Light Peach (106), Pearl Gray (107),
Black (110), Lime-ade (113),
Brazil Brown (116), Dark Peach (117),
Sherwood Green (119),

Amazon Blue (123), White (148),
Tuscan Gold (171), Sky Blue (177),
Taupe (199), Citrus Orange (220),
Ever Red (221), Orange Pizzazz (222),
Slate Blue (401), Blush (409),
Raspberry Cream (410), Teal (414),

Olive Green (428), Key Lime (429),
Real Rust (501), Mustard (504),
Cherry Red (505), Suede Brown (508),
Signal Red (510), Bayleaf
Brown (513), Earthen Gold (514),

Robin Egg Blue (518), Cambro
Red (521), Burgundy Wine (522),
Lemon Chiffon (536), Cameo
Yellow (537), Cottage White (538),
Grape (551).

Due to the catalog printing process, the colors & patterns shown may not be exact.
Contact Cambro or a Cambro representative for a color chip.

NON-SKID VERSA CAMTRAYS®



- Non-Skid Camtrays provide a better grip for safer meal delivery.
- Dishwasher safe in low and high temperatures.
- Stacking lugs keep trays stacked securely in place and ensure proper air flow.
- Ergonomic handles allow for safe and elegant meal delivery.
- Trays fit within existing meal delivery carts, that accommodate 15" x 20" and 14" x 18" trays.

Colors: Black with Pebbled Black (382), Pearl Gray with Titan (381), Ivory with Sahara (380).

Non-Skid Versa Camtrays with Handles are covered by U.S. Patent D 683,191 S.

NSF Listed for non-direct food contact only.



Personalization available. Visit www.cambro.com for details.



1418VCH



1418VC

Black with Pebbled Black (382)

Pearl Gray with Titan (381)

Ivory with Sahara (380)

CODE	DIMENSIONS	CASE PACK	LIST PRICE EA.
Non-Skid Versa Camtrays			
1418VC	14" x 18"	12	\$ 39.25
1520VC	15" x 20"	12	43.90
Non-Skid Versa Camtrays with handles			
1418VCH	14" x 18"	12	40.60
1520VCRST	15" x 20"	12	46.20

CAMWEAR® TRAYS

Camwear Trays

- Ideal for use in correctional facilities.
- Made from durable Camwear.
- Stacking lugs keep trays stacked securely in place and ensure proper air flow.

Colors: Blue (168), Beige (133), Black (110), Dark Cranberry (488), Smoked Metal (485).

NSF Listed for non-direct food contact only.



CODE	DIMENSIONS	CASE PACK	LIST PRICE EA.
Rectangular			
1418CW	13 ¹⁵ / ₁₆ " x 17 ¹⁵ / ₁₆ "	12	\$ 24.95
1520CW	14 ⁷ / ₈ " x 20 ⁷ / ₈ "	12	25.95
Rectangular with Handles			
1418CWH New!	13 ¹⁵ / ₁₆ " x 17 ¹⁵ / ₁₆ "	12	34.55
1520CWH New!	14 ⁷ / ₈ " x 20 ⁷ / ₈ "	12	38.65
Trapezoid			
1418TRCW	14" x 18"	12	24.95



Camwear Non-Skid Trays

- Ideal for use in high-traffic cafeterias.
- Made from durable Camwear.
- Non-skid clear textured surface is scratch resistant and ensures drinks and meals stay in place during transport.
- Stacking lugs keep trays stacked securely in place and ensure proper air flow.
- Commercial dishwasher safe at high and low temperatures.

Colors: Black (110), Smoked Metal (485), Dark Cranberry (488).

These trays are not recommended for use in heated carts.

NSF Listed for non-direct food contact only.



CODE	DIMENSIONS	CASE PACK	LIST PRICE EA.
Non-skid tray			
1418CWNS	14" x 18"	12	\$ 39.25
1520CWNS	15" x 20"	12	43.90
Non-skid tray with handles			
1418CWNSH New!	14" x 18"	12	40.60
1520CWNSH New!	15" x 20"	12	46.20

1418CWNS and 1520CWNS InStock Colors:

Black (110), Smoked Metal (485), Dark Cranberry (488).

1520CWNSH InStock Colors: Black (110), Smoked Metal (485).

Black (110)

Dark Cranberry (488)

Smoked Metal (485)



EPICTREAD™ TRAYS

- Durable molded-in, non-skid surface for years of fast-paced, epic service!
- Sleek handles for a more balanced grip.
- Personalized with any design of your choice. Bottom: digital printing or silkscreen printing. Top: Silkscreen only.
- Stacking lugs enhance air circulation for quick, effective drying and perfect stacking.

Personalization with minimum order of 144 trays.

 Not for use with hot items over 190°F.

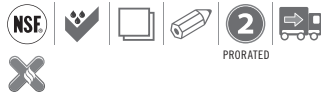

New!



Tray Colors:



CODE	DIAMETER	CASE PACK	LIST PRICE EA.
1400ET	15 3/8"	12	\$ 27.45
1600ET	17 1/4"	12	36.20

InStock Colors: Black (110), Dark Burgundy Wine (207).

HOTEL ROOM SERVICE TRAY

- Lightweight, weighs up to 30% less than wood room service trays.
- Dishwasher safe once a day, easily wipes clean. Saves time and labor.
- Standard 14" x 19" tray mat can be used on the surface of the tray.

Colors: Brushed Steel (612), Venge (384), Walnut (376).

NSF listed for non-direct food contact only.



Venge (384)

Walnut (376)

Brushed Steel (612)

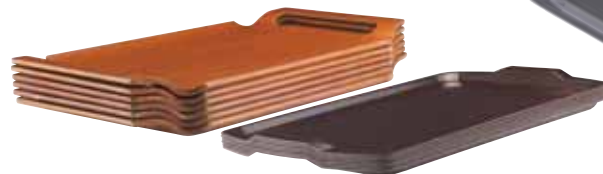

Up to 50% greater stacking capacity than comparable wood trays.

CODE	OUTER DIMENSION	INNER DIMENSION	LIST PRICE EA.
1525RST	15 1/2" x 25"	14" x 21"	\$ 32.40

Case Pack: 12



CAMTREAD® TRAYS

- An industry standard for caterers, hotels, banquet halls, dining rooms and bars.
- Non-skid surface ensures drinks and meals stay in place during transport.
- Made of heavy-duty, durable fiberglass with a thick molded in, non-skid surface.

Orders for non-standard Camtread Tray colors will be handled by special quotation only.

*Special order item not carried in stock, non-returnable. One case order minimum.

Not for use in heated carts.

**Personalization available on 1600CT only.



Non-skid trays mean less breakage and greater profits.



5 FIVE YEAR PRORATED WARRANTY AGAINST MANUFACTURER'S DEFECTS

Tray Colors:



CODE	DIMENSIONS	CASE PACK	LIST PRICE EA.
Round			
900CT*	9"	12	\$ 18.75
1100CT	11"	12	18.75
1400CT	14"	12	24.95
1550CT*	16" low profile	12	33.90
1600CT**	16"	12	32.90
1800CT	18"	6	46.65
1950CT*	19 ¹ / ₁₆ " low profile	12	47.75
Oval			
2500CT	19 ¹ / ₄ " x 23 ³ / ₄ "	6	59.40
2700CT	22" x 26 ⁵ / ₈ "	6	66.85
2900CT	28 ³ / ₈ " x 23 ¹ / ₂ "	6	75.85
Rectangular			
1014CT*	10 ⁵ / ₈ " x 13 ³ / ₄ "	12	23.10
1216CT*	12" x 16 ⁵ / ₁₆ "	12	26.70
1418CT	14" x 18"	12	33.25
1520CT*	15" x 20 ¹ / ₄ "	12	37.80
1622CT*	16" x 22"	12	46.65
1826CT	17 ¹³ / ₁₆ " x 25 ¹¹ / ₁₆ "	6	56.00
3253CT*	12 ³ / ₄ " x 20 ⁵ / ₈ "	12	38.90

InStock Colors: Black Satin (110), Tavern Tan (138).
1950CT and 3253CT special order only available in Tavern Tan (138).



TREADLITE™ TRAY

- Fiberglass reinforced polyester lightweight tray has a molded in non-skid surface.
- Non-skid surface ensures items stay in place during service.
- Reinforced edges provide superior strength and protection.
- Stacking lugs keep trays stacked securely in place and ensure proper air flow.



CODE	DIAMETER	LIST PRICE EA.
1400TL	14"	\$ 15.00
1600TL	16"	20.00

Case Pack: 12 InStock Colors: Black Satin (110), Tavern Tan (138).

Tray Colors:

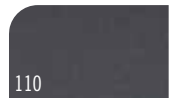

110
Black Satin



138
Tavern Tan

POLYTREAD® TRAYS

- An economical service tray for restaurants, bars and banquet service.
- General, all-purpose, non-skid service trays help reduce spills and breakage.
- Non-skid surface is bonded directly into a lightweight polypropylene tray.
- Stacking lugs keep trays stacked securely in place and ensure proper air flow.



PT1100

PT1400

PT1600

PT1216

PT1014

PT1418

CODE	DIMENSIONS	CASE PACK	LIST PRICE EA.
Round			
PT1100	11"	12	\$ 10.65
PT1400	14"	12	14.25
PT1600	16"	12	19.25
Rectangular			
PT1014	10 ⁹ / ₁₆ " x 13 ⁵ / ₈ "	24	13.70
PT1216	11 ⁷ / ₈ " x 16 ¹ / ₄ "	24	14.90
PT1418	14" x 18"	12	18.90

Tray Colors:

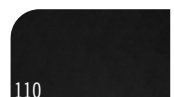

110
Black

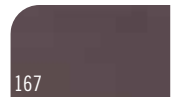

167
Brown

PROMOTE YOUR BRAND – PERSONALIZED CAMTREAD® TRAYS

Personalize Camtread Trays to display a message with every tray served. Advertise a product, promote your business, enhance patient satisfaction or strengthen school spirit.

 Look for this icon that identifies items that can be personalized.

Camtread Trays

Tray Back Personalization Digital Printing Process:

Allows printing of multiple color artwork as well as photo reproduction.

Printable Area:

The artwork can cover the flat surface of tray up to 1" from the external tray edge.

Only available on 1600CT.

Tray Order Minimum: 72

Tray Back Personalization Charges Per Tray:

QUANTITY EACH	ADDITIONAL NET CHARGES
72-144	\$ 0.75
145-288	0.50
289-432	0.25
433 and up	Free

White trays are recommended for tray back personalization.

Rubber Surface Embossing Electronic File Format:

Adobe Illustrator EPS formats.

Embossing Process Printable Area:

The artwork can cover the surface of the tray up to 1" from the internal tray edge.

Available on all Camtread Trays.

Embossing Personalization Charge Per Tray:

QUANTITY EACH	ADDITIONAL NET CHARGES
72 and up	\$ 1.00

Tray Order Minimum: 72

TRAY BACK
PERSONALIZATION



EMBOSSING



How To Order A Sample

1. Request a Sample

Contact your local Cambro representative to complete and submit the sample request form to Cambro.

2. Provide Artwork

Provide ready to use artwork, digital format only. Sample request form must be submitted to Cambro PRIOR to artwork being sent. If artwork is incomplete, graphic support services are available for \$50.00 per hour.

3. Submit Artwork

E-mail artwork to Cambro Rep or to Cambro at letsgetpersonal@cambro.com. Title e-mail subject with logo name and provide contact info.

File dimensions: 100% reproduction size, 300 dpi resolution.

File type:

Adobe® Illustrator®, Photoshop®.

File format: jpeg, tiff, and eps. Or mail artwork on a CD-ROM to: Cambro Attn: Kristie Patterson, 7601 Clay Avenue, Huntington Beach, CA 92648.

4. Questions

Contact Kristie Patterson at 714-230-4125 direct or 800-854-7631 ext. 4125.

5. Sample Approval

A signed sample approval form must be faxed to Cambro customer service prior to processing any purchase orders. This form is included with each sample.

6. Sample Turnaround

7-10 business days.

* All personalized tray orders are full case quantities only; no broken cartons.

7. Personalization Charges (NET)

Tray Sample:

\$ 50.00 (Charge will be billed on sample order, credited on first purchase order.)

FAST FOOD TRAY

- Perfect for self-serve or quick-serve dining.
- Made of durable polypropylene.
- Attractive textured surface hides scratches.



CODE	DIMENSIONS	CASE PACK	LIST PRICE EA.
1014FF	10 $\frac{7}{16}$ " x 13 $\frac{9}{16}$ "	24	\$ 4.70
1216FF	11 $\frac{7}{8}$ " x 16 $\frac{7}{8}$ "	24	5.65
1418FF	13 $\frac{3}{16}$ " x 17 $\frac{3}{4}$ "	12	7.25

InStock Colors: Black (110), Red (163).



Promote Your Brand – Fast Food Trays

Personalized Fast Food Trays display a message with every tray served. Advertise products, promote your business and brand or strengthen school spirit.

Available Colors:



How To Order A Sample

1. Request a Sample

Contact your local Cambro rep to complete and submit the sample request form to Cambro. Specify location of imprint on tray. Maximum imprint size: 6" x 6".

2. Provide Artwork

Provide ready to use artwork, digital format only. Sample request form must be submitted to Cambro **PRIOR** to artwork being sent. If artwork is incomplete, graphic support services will be offered for \$ 50.00 per hour.

3. Submit Artwork

E-mail artwork to your Cambro Rep or the Cambro Personalization Dept. at letsgetpersonal@Cambro.com. Title e-mail subject with logo name and provide contact info.

File dimensions: 100% reproduction size, 300dpi resolution.

File type:

Adobe® Illustrator®, Photoshop®. **File format:** jpeg, tiff, and eps. Or mail artwork on a CD-ROM to: Cambro Manufacturing Company Attn: Kristie Patterson, Cambro, Personalization Dept., 7601 Clay Avenue, Huntington Beach, CA 92648.

4. Questions

Call Kristie Patterson at 714-230-4125 direct or 800-854-7631 ext. 4125.

5. Sample Approval

Signed approval form must be faxed to Cambro customer service prior to processing any purchase orders. Approval form included with each sample tray.

Personalization Charges (Net)

Tray Sample

\$50.00 (Charge will be billed on sample order, credited on first purchase order)

Custom Die Charge

\$100.00 (Billed on sample order, one time charge)

TRAY QUANTITY	COST PER TRAY
288-767	\$ 0.36
768-1199	0.27
1200-5999	0.18
6000-11,999	0.14
12,000 +	0.12

MARKET TRAYS AND PANS

- Attractively merchandise desserts, pastries, hors d'oeuvres and salads.
- Ideal for use in bakeries, supermarkets and delis.
- High-impact resistant fiberglass.
- Trays and pans resist odors and will not oxidize like aluminum trays.
- Pans feature a 2" (5 cm) rim for salads and ready to eat foods.

Colors: Yellow (145)*, Blue (142), Green (140), White (148), Black (110).

*NSF Listed for non-direct food contact only.



Market Trays make appealing bakery merchandising quick and easy.



Market Pans showcase deli items.

CODE	DIMENSIONS W x L x D	CASE PACK	LIST PRICE EA.
Market Trays			
630MT	6 ⁷ / ₁₆ " x 30" x 3 ³ / ₄ "	12	\$ 20.60
826MT	8 ³ / ₄ " x 25 ¹ / ₂ " x 3 ³ / ₄ "	12	16.85
830MT	8 ⁷ / ₁₆ " x 30" x 3 ³ / ₄ "	12	23.25
913MT	8 ⁷ / ₈ " x 12 ³ / ₄ " x 1"	12	18.00
918MT	8 ¹ / ₁₆ " x 18" x 1 ¹³ / ₁₆ "	12	19.55
926MT	8 ⁷ / ₈ " x 25 ⁵ / ₁₆ " x 1"	12	21.75
1015MT	10 ¹ / ₈ " x 15" x 3 ³ / ₄ "	24	16.30
1030MT	10 ¹ / ₁₆ " x 30" x 3 ³ / ₄ "	12	25.75
1218MT	11 ¹ / ₂ " x 17 ³ / ₄ " x 1"	12	20.30
1224MT	12 ¹ / ₁₆ " x 24" x 3 ³ / ₄ "	12	25.45
1230MT	12 ¹ / ₁₆ " x 30" x 3 ³ / ₄ "	12	29.55
1318MT	12 ⁵ / ₈ " x 17 ³ / ₄ " x 1 ¹ / ₁₆ "	12	20.85
1826MT	17 ¹³ / ₁₆ " x 25 ¹¹ / ₁₆ " x 1 ¹ / ₁₆ "	6	33.25
2025MT	20 ³ / ₄ " x 25 ⁵ / ₁₆ " x 1 ¹³ / ₁₆ "	6	43.50
Market Pans			
6302MT	6 ⁷ / ₁₆ " x 30" x 2"	12	32.30
8262MT	8 ³ / ₈ " x 25 ¹ / ₂ " x 2"	12	26.45
8302MT	8 ⁷ / ₁₆ " x 30" x 2"	12	35.55
92615MT	8 ⁷ / ₈ " x 25 ¹ / ₂ " x 1 ¹ / ₂ "	12	21.70
10302MT	10 ¹ / ₁₆ " x 30" x 2"	12	38.00

Special order item not carried in stock, non-returnable. One case order minimum.

CAMLITE® TRAYS

- An economical, all-purpose tray for self-serve food service dining.
- Made of fiberglass with reinforced corners.
- Stacking lugs keep trays stacked securely in place and ensure proper air flow.

Colors: Rose Red (163), Yellow (145), Green (162), Blue (142), Tan (161), Steel White (676), Steel Red (675), Steel Blue (674), Black (110).



CODE	DIMENSIONS	CASE PACK	LIST PRICE EA.
Rectangular			
1014CL	10 ⁵ / ₈ " x 13 ³ / ₄ "	12	\$ 14.55
1216CL	12" x 16 ⁵ / ₁₆ "	12	16.50
1418CL	14" x 18"	12	18.80
1520CL	15" x 20 ¹ / ₄ "	12	21.50
1826CL	17 ⁷ / ₈ " x 25 ³ / ₄ "	12	30.90
3253CL	12 ³ / ₄ " x 20 ⁷ / ₈ "	12	18.55

COMPARTMENT TRAY

- Perfect for school lunch programs or cafeteria-style feeding in correctional facilities.
- Textured surface resists scratching.
- All are FDA approved for food contact.
- Camwear® is made with virtually unbreakable material.
- Budget is made with ABS.
- Penny-Saver is made with economical co-polymer.

ABS and Co-Polymer trays are not NSF listed.



EcoSafe

Cambro Trays

Saves 110 lbs of trash in disposable trays per day or 9.26 tons of trash per year from trays for just one school district.*

*This number is approximate. The average school district in the U.S. is about 10,000 students and the average number of in-session school days is 175.

Camwear Colors



Budget Colors



Penny-Saver Colors



PS1014

150CW, 100CW, 50CW, 45CW, 35CW, 10CW and SRB5CW reusable bowls fit in this tray and can be used to serve cereal, soup & salads.



BCT1014



BCT1014, PS1014 & 10146CW

CODE	DIMENSIONS W x L x D	LIST PRICE EA.
Camwear		
10146CW	10" x 14½" x ¾"	\$ 13.70
Budget - BPA FREE		
BCT1014	10" x 14½" x ¾"	10.35
Penny-Saver - BPA FREE		
PS1014	10" x 14½" x ¾"	6.45



PS1014 on OETR314 Open End Tray Rack.

2 X 2 COMPARTMENT TRAYS

- Perfect for school lunch programs or cafeteria-style feeding in correctional facilities.
- Gradual sloping compartment walls promote quick draining and faster drying.
- "Easy grip" handles ensure a better grip for children with smaller hands.
- 915CW, 100CW, SRB13CW and 50CW bowls fit in round compartment.
- 10CW and 150CW bowls fit in square compartment.

Camwear® trays are NSF Listed.
 Co-Polymer trays are not NSF listed.



Styrofoam, the material that many disposable trays are made from, can make up to 30% of the trash volume in landfills.

Cambro Trays are made from FDA approved materials.

Camwear Colors



Co-Polymer Colors



915CP



1596CW

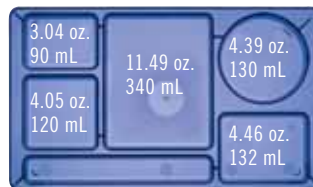

915CW & 915CP

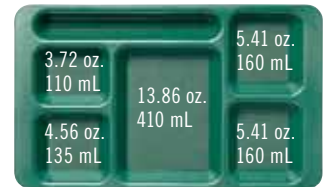

1596CW & 1596CP

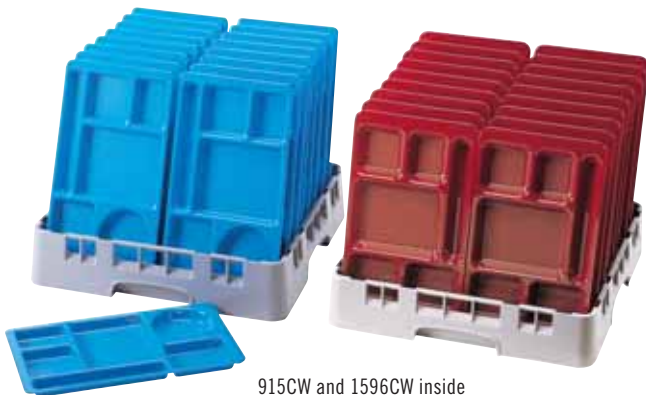

915CW and 1596CW inside two PR314 Camracks.

CODE	DIMENSIONS W x L x D	LIST PRICE EA.
Camwear		
1596CW	9" x 15" x 7/8"	\$ 12.05
915CW	8 3/4" x 15" x 3/4"	12.05
Co-Polymer - BPA FREE		
1596CP	9" x 15" x 7/8"	6.80
915CP	8 3/4" x 15" x 3/4"	6.80

Case Pack: 24

COMPARTMENT SERVING TRAYS

- For meal delivery in correctional facilities.
- Compartment configurations designed to meet all menu requirements.

Camwear® 6-Compartment Colors: Navy (186), Cranberry (416), Yellow (145), Sherwood Green (119), Beige (133), Black (110).
5-Compartment Colors: Beige (133), Yellow (145).



Co-Polymer Not NSF Listed Color: Tan (161).

Withstands Temperatures From
Camwear: -40° to 210°F (-40° to 99°C).
Co-Polymer: -40° to 210°F (-40° to 99°C).



NT9CP Co-Polymer Cup:
 For details contact your Cambro representative.



10146CW

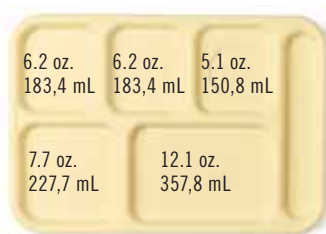

10146CW



10145CW

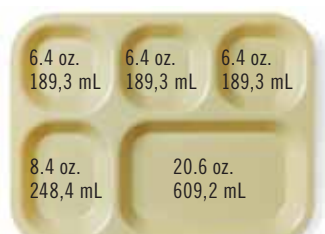

14105CW and 14105CP

Camwear Colors

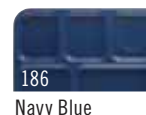

Co-Polymer Color



CODE	DESCRIPTION	DIMENSIONS W x L x D	LIST PRICE EA.
Camwear			
10146CW	6 Compartments	10" x 14½" x 1⅝"	\$ 13.70
14105CW	5 Compartments	10⅙" x 13⅜" x 1⅝"	15.00
10145CW	5 Compartments	10" x 14½" x 1⅝"	14.95
Co-Polymer - BPA FREE			
14105CP	5 Compartments	10⅙" x 13⅜" x 1⅝"	6.90

Case Pack: 24

TRAPEZOID COMPARTMENT TRAY

- Space saving tray for self serve correctional facility feeding.
- Offers seven deep compartments for ample, portion controlled servings.
- Serve soup and salad at the same time.

Camwear Color: Beige (133).
Withstands Temperatures From
Camwear: -40° to 210°F (-40° to 99°C).
 Trapezoid Compartment Trays are covered by the following U.S. Patent D 508,634.



Camwear Color



CODE	DESCRIPTION	DIMENSIONS W x L x D	LIST PRICE EA.
Camwear Trapezoid Tray			
14187TRCW	7 Compartments	14" x 17⅙" x 1½"	\$ 26.90

Case Pack: 12

MEAL DELIVERY TRAYS

- Three deep-dish food compartments for large portions.
- Snap-on cover fits securely.
- Textured surface minimizes scratching.

Camwear® Colors:
Beige (133), Teal (414).
Lid Color: Clear (135).



Co-Polymer Not NSF Listed Colors:
Teal (414), Brown (167), Tan (161).
Lid Color: White (148).

Withstands Temperatures From
Camwear: -40° to 210°F (-40° to 99°C).
Co-Polymer: -40° to 210°F (-40 to 99°C).

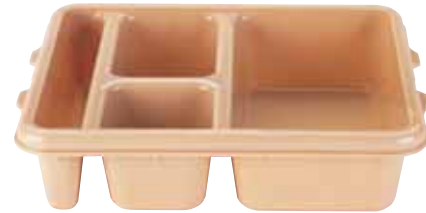

Camwear Colors



133
Beige



414
Teal

Co-Polymer Colors

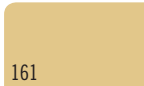

161
Tan

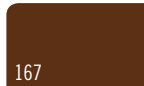

167
Brown



414
Teal

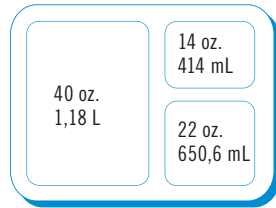

9113CW/9113CP

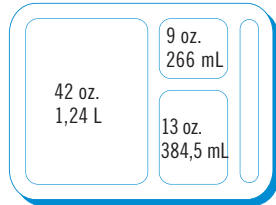

9114CW/9114CP

CODE	DESCRIPTION	DIMENSIONS W x L x D	LIST PRICE EA.
Camwear			
9113CW	3 Compartments	9" x 11" x 2 ¹¹ / ₁₆ "	\$ 16.05
9114CW	4 Compartments	9" x 11" x 2 ¹¹ / ₁₆ "	16.75
911CWC	Lid fits both trays	9" x 11" x 9 ⁹ / ₁₆ "	11.35
Co-Polymer - BPA FREE			
9113CP	3 Compartments	8 ⁷ / ₈ " x 10 ¹¹ / ₁₆ " x 2 ⁵ / ₈ "	7.05
9114CP	4 Compartments	8 ¹⁵ / ₁₆ " x 10 ³ / ₄ " x 2 ⁵ / ₈ "	7.05
911CPC	Lid fits both trays	8 ¹⁵ / ₁₆ " x 10 ¹³ / ₁₆ " x 9 ⁹ / ₁₆ "	3.85

Case Pack: 24

SEPARATOR® COMPARTMENT TRAY

- Six compartment tray designed specifically for in-cell feeding programs.
- Serve both hot and cold food from the same tray.
- Tray with cover separates each compartment to retain food temperature and reduce spills.
- Locking ridges on top of cover and bottom of tray ensure more secure stacking.

Camwear Color: Beige (133).
Lid Color: Clear (135).



Co-Polymer Not NSF Listed Colors:
Teal (414), Brown (167), Tan (161).
Lid Color: Translucent (190).

Withstands Temperatures From
Camwear: -40° to 210°F (-40° to 99°C).
Co-Polymer: -40° to 210°F (-40° to 99°C).



10146DCW



10146DCP

Camwear Color

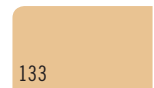

133
Beige

Co-Polymer Colors

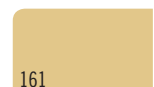

161
Tan

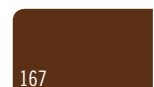

167
Brown



414
Teal

CODE	DESCRIPTION	DIMENSIONS W x L x D	LIST PRICE EA.
Camwear			
10146DCW	6 Compartments	10" x 14 ³ / ₁₆ " x 1 ¹ / ₁₆ "	\$ 17.60
10146DCWC	Lid fits 10146DCW	10 ³ / ₄ " x 14 ³ / ₄ " x 1 ¹ / ₁₆ "	9.35
Co-Polymer - BPA FREE			
10146DCP	6 Compartments	9 ¹⁵ / ₁₆ " x 13 ¹⁵ / ₁₆ " x 1 ¹ / ₁₆ "	9.00
10146DCPC	Lid fits 10146DCP	10 ¹ / ₁₆ " x 14 ¹ / ₁₆ " x 1 ¹ / ₁₆ "	5.25

Case Pack: 24

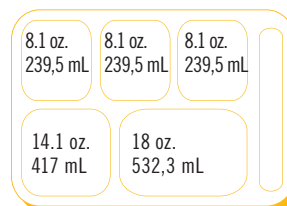

TRAY ON TRAY MEAL DELIVERY SYSTEM

Base Tray

- Combine hot and cold food portions into a reusable, single service unit.
- Works as a tray or for in-cell feeding with the insert tray.
- Base tray has 5 compartments with 1 compartment for nesting the insert tray.

Camwear® Color: Beige (133).



Co-Polymer Not NSF Listed Colors:
Brown (167), Tan (161).

Withstands Temperatures From
Camwear: -40° to 210°F (-40° to 99°C).
Co-Polymer: -40° to 210°F (-40° to 99°C).



1411CW



1411CW base tray with 853FH insert tray

Camwear Color

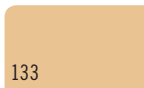

133
Beige

Co-Polymer Colors

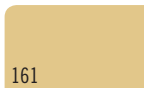

161
Tan



167
Brown

11.8 oz. 349 mL	6.7 oz. 198,1 mL	6.7 oz. 198,1 mL
11.8 oz. 349 mL	23.6 oz. 697,9 mL	

1411CW/1411CP

CODE	DESCRIPTION	DIMENSIONS W x L x D	LIST PRICE EA.
Camwear			
1411CW	5 Compartments	10 ⁹ / ₁₆ " x 14 ³ / ₈ " x 1 ¹ / ₄ "	\$ 17.50
Co-Polymer - BPA FREE			
1411CP	5 Compartments	10 ⁹ / ₁₆ " x 14 ³ / ₈ " x 1 ¹ / ₄ "	6.35

Case Pack: 24

Insert Trays

- Eight trays efficiently fit on a standard sheet pan or in an 18" x 26" (45,5 x 65,5 cm) wire rack.

Camwear Color: Beige (133).



Lid Color: Clear (135).

Co-Polymer Not NSF Listed Colors:
Brown (167), Tan (161).

Lid Color: Translucent (190).

Heat Resistant Plastic Tray and
Lid Color: Amber (150).

Withstands Temperatures From
Camwear: -40° to 210°F (-40° to 99°C).
Co-Polymer: -40° to 210°F (-40° to 99°C).
Heat Resistant Plastic:
-40° to 300°F (-40° to 149°C).



853FCW

853FCP

Camwear Color

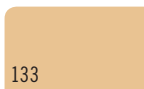

133
Beige

Co-Polymer Colors

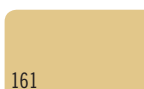

161
Tan



167
Brown

Heat Resistant Plastic Color

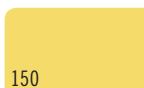

150
Amber

7 oz. 207 mL	21 oz. 621 mL
7 oz. 207 mL	

CODE	DESCRIPTION	DIMENSIONS W x L x D	LIST PRICE EA.
Camwear			
853FCW	3 Compartments	6 ⁵ / ₁₆ " x 8 ¹¹ / ₁₆ " x 1 ⁷ / ₈ "	\$ 11.35
853FCWC	Lid for 853FCW	6 ³ / ₄ " x 8 ¹³ / ₁₆ " x 1 ¹ / ₄ "	6.00
Co-Polymer - BPA FREE			
853FCP	3 Compartments	6 ¹ / ₄ " x 8 ⁹ / ₁₆ " x 1 ¹ / ₈ "	5.65
853FCPC	Lid for 853FCP	6 ³ / ₄ " x 8 ¹³ / ₁₆ " x 1 ¹ / ₄ "	3.00
Heat Resistant Plastic			
853FH	3 Compartments	6 ⁵ / ₁₆ " x 8 ¹¹ / ₁₆ " x 1 ⁷ / ₈ "	22.85
853FHC	Lid for 853FH	6 ³ / ₄ " x 8 ¹³ / ₁₆ " x 1 ¹ / ₄ "	13.15

Case Pack: 24



healthcare



HEALTHCARE

Non-Skid Versa Camtrays®

Camwear® Non-Skid Trays

Camtray with Handles

Meal Delivery Ware Systems

Disposable CamLids®

Temperature Retention Systems

Camduction® Complete Heat System

Camtherm® Plate Heater

Reusable CamLids for Meal Delivery Systems

Camrack® Wash and Store Rack

Camshelving® Hygienic Drying Racks

Meal Delivery Carts for Tray Service



NON-SKID VERSA CAMTRAYS®

- Non-Skid Trays reduce waste, save money and provide a stable tray surface for meal delivery.
- Switching from paper tray mats will generate annual savings of over 50%.
- Green initiatives will get rapid results with the elimination of tons of trash each year.
- Non-Skid Camtrays provide a better grip for safer meal delivery.
- Dishwasher safe in low and high temperatures.
- Stacking lugs keep trays in place and ensure proper airflow between trays.

Colors:
 Black with Pebbled Black (382),
 Pearl Gray with Titan (381),
 Ivory with Sahara (380).

.....

NSF Listed for non-direct food contact only.

.....

Personalization available.
 Visit www.cambro.com for details.

.....



Non-skid trays grip tray top items firmly.



CODE	DESCRIPTION	DIMENSIONS	LIST PRICE EA.
1418VC	Non-Skid Versa Camtray	14" x 18"	\$ 39.25
1520VC	Non-Skid Versa Camtray	15" x 20"	43.90

Case Pack: 12

Visit www.cambro.com/savemoney to see how much you can save by eliminating your purchase of paper mats.

NON-SKID VERSA CAMTRAYS WITH HANDLES

- Ergonomic handles allow for safe and elegant meal delivery.
- Non-skid surface eliminates the need for tray mats saving time and money.
- Trays fit within existing meal delivery carts that accommodate 14" x 18" or 15" x 20" trays.
- Dishwasher safe at high and low temperatures.
- Stacking lugs keep trays in place and ensure proper airflow between trays.
- 15" x 20" tray is ideal for room service.

Colors:
 Black with Pebbled Black (382),
 Pearl Gray with Titan (381),
 Ivory with Sahara (380).

.....

Non-Skid Versa Camtrays for Room Service with Handles are covered by U.S. Patent D 683,191 S.

.....

NSF Listed for non-direct food contact only.

.....

Personalization available.
 Visit www.cambro.com for details.

.....



CODE	DESCRIPTION	DIMENSIONS	LIST PRICE EA.
1418VCH	Non-Skid Versa Camtray with handles	14" x 18"	\$ 40.60
1520VCRST	Non-Skid Versa Camtray with handles	15" x 20"	46.20

Case Pack: 12

Black with Pebbled Black (382)

Pearl Gray with Titan (381)

Ivory with Sahara (380)

CAMWEAR® TRAYS AND NON-SKID TRAYS

- Ideal for healthcare patient meal delivery and in high-traffic cafeterias.
- Scratch-resistant, made of durable Camwear.
- Non-skid surface eliminates the need for tray mats, saving time and money.
- Enhances stability, providing safer transport and service.
- Stacking lugs keep trays in place and ensure proper airflow between trays.
- Commercial dishwasher safe at high and low temperatures.
- Trays with handles are also available without non-skid surface.

Colors: Black (110), Dark Cranberry (488), Smoked Metal (485).

Not recommended for use in heated carts.

NSF Listed for non-direct food contact only.

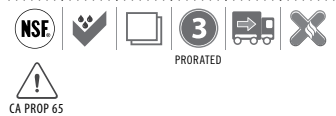

1520CWNS

Black (110)

Dark Cranberry (488)

Smoked Metal (485)

CODE	DESCRIPTION	DIMENSIONS	LIST PRICE EA.
Non-Skid			
1418CWNS	Without handles	14" x 18"	\$ 39.25
1520CWNS	Without handles	15" x 20"	43.90
1418CWNSH New!	With handles	14" x 18"	40.60
1520CWNSH New!	With handles	15" x 20"	46.20
Without Non-Skid			
1418CWH New!	With handles	14" x 18"	34.55
1520CWH New!	With handles	15" x 20"	38.65

Case Pack: 12 1418CWNS, 1520CWNS InStock Color: Black (110), Smoked Metal (485), Dark Cranberry (488). 1520CWNSH InStock Color: Black (110), Smoked Metal (485).



1520CWNSH

CAMTRAYS® WITH HANDLES

- Enhance your tray presentation with easy-to-grip, ergonomic, contoured handles.
- Stain and odor resistant.
- Made of durable lightweight and high-impact fiberglass.
- Stacking lugs keep trays in place and ensure proper airflow between trays.
- Dishwasher safe at high and low temperatures.

Available in Group I colors.

Special order item not carried in stock, non-returnable. One case order minimum.

NSF listed for non-direct food contact only.

Personalization through digital printing process only. Please refer to Camtray Personalization section for details.



1520H

CODE	DESCRIPTION	DIMENSIONS	LIST PRICE EA.
1418H	Camtray with handles	14" x 18"	\$ 25.00
1520H	Camtray with handles	15" x 20"	29.75

Case Pack: 12

MEAL DELIVERY WARE SYSTEM – THE HARBOR COLLECTION

- Attractive design provides a pleasant dining experience.
- Supports temperature maintenance.
- Available in six popular colors to complement any decor.
- Mugs and bowls fit Cambro disposable CamLids®.
- Made of durable polypropylene, won't chip or break.
- High temperature dishwasher safe.
- Dome fits 9" plate.
- Industry's only NSF listed insulated ware line.

Domes and delivery ware are not designed for microwave use.

Insulated Harbor bowl is covered by U.S. Patent D795,017 S.



CODE	MDSHD9	MDSHB5	MDSHB9	MDSHM8
DESCRIPTION	Insulated dome cover for 9" plate	Insulated small bowl	Insulated large bowl	Insulated mug
LID CODE	—	CLSM8B5, CLRSM8B5	CLSB9, CLRSB9	CLSSM8B5, CLSM8B5, CLRSM8B5
APPROX. CAPACITY	—	5 oz.	9 oz.	8 oz.
OUTSIDE DIAMETER	10¼"	3½"	4¾"	4½"
HEIGHT	3⅜"	2⅝"	2⅝"	4"
CASE PACK	12	48	48	48
LIST PRICE EACH	\$ 18.55	\$ 3.00	\$ 3.00	\$ 3.00

InStock Color: Smoked Metal (485).

Harbor Meal Delivery Ware Colors:



MEAL DELIVERY WARE SYSTEM – THE SHORELINE COLLECTION

- Classic design, high performance, and unequalled safety at a budget-friendly price.
- Works with all Cambro Temperature Retention Systems, Camduction® Complete Heat System, Camtherm® Thermal Pellet System, Heat Keeper Insulating Base System and Camchiller® Pellet System.
- Mugs and bowls fit Cambro® disposable CamLids®.
- Industry's only NSF listed ware line.
- Domes and delivery ware are made of durable polypropylene.

Domes and delivery ware are not designed for microwave use.



Meadow (447)



Wheat (457)



Speckled Gray (480)



Cranberry (487)



Navy Blue (497)



Black (110)

Low Profile Dome Comparison

Perfect for limited tray spacing as low as 4½".

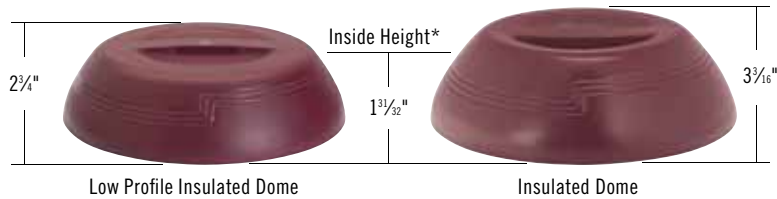

*This height is measured from a flat surface.

Insulated Meal Delivery Ware



CODE	MDSM8	MDSB5	MDSB9	MDSB16
DESCRIPTION	Mug	Sm. bowl	Lg. bowl	Entree bowl
APPROX. CAPACITY	8 oz.	5 oz.	9 oz.	16.9 oz.
OUTSIDE DIAMETER	3½" *	3½"	4¾"	5¾"
HEIGHT	4"	2⅝"	2⅝"	2⅝"
FULL-SIZE CAMRACK®	16C414	16C414	9S318	9S318
LIST PRICE EACH	\$ 3.00	\$ 3.00	\$ 3.00	\$ 5.85

Case Pack: 48 *MDSM8 Diameter 4 1/2" with Handle. **InStock Colors.

Shoreline Meal Delivery Ware Colors:



TEMPERATURE RETENTION SYSTEMS

Camduction® Complete Heat System

The most efficient heat retention solution, holds hot food at safe temperatures 140°F or higher for 45 minutes.

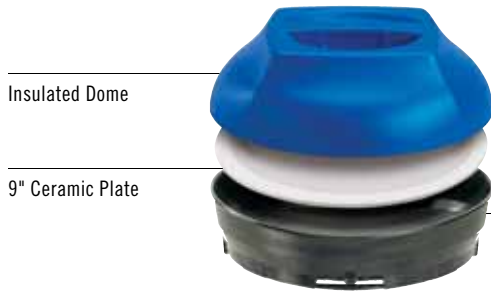

Camduction Base

- Camduction Bases are durable and dishwasher safe.
- Resistant to chips, cracks and breaks.
- Revolutionary technology eliminates errors or issues with spikes in voltage.
- 2 year pro-rated warranty on bases.
- Holds a 9" plate.

MDSPLT9 Color: White (148).
MDSPLT9 Sold in full cases only.

MDS9, MDSL9 and MDSCDB9 Colors:
Meadow (447), Wheat (457),
Speckled Gray (480), Cranberry (487),
Navy Blue (497), Black (110).

MDSCDB9 is covered by U.S. Patent
D 630, 8975 S. and 8,263,906 B2.



Camtherm® Thermal Pellet System

The perfect choice for maximum heat retention, holds temperature for 60 minutes or more.



Camtherm Thermal Pellet

- Holds heat at its core to keep hot foods at safe temperatures.
- Stays 20°F cooler on the edge than metal pellets to protect staff and patients from burns.
- Is a high-density plastic material that won't dent like metal pellets.
- Holds a 9" plate.

MDSP9 Color: Dark Gray (477).

MDSPLT9 Color: White (148).
MDSPLT9 Sold in full cases only.

MDS9, MDSL9 and MDSL9 Colors:
Meadow (447), Wheat (457),
Speckled Gray (480), Cranberry (487),
Navy Blue (497), Black (110).

MDSPL Color: (000).



Heat Keeper Insulating Base System

The cost-effective solution for heat retention, holds temperature for 20 minutes or more.



Heat Keeper Insulating Base

- Maintains heat for at least 20 minutes.
- Cost-effective solution to maintain meal delivery temperatures.
- Resists stains, odors and scratches.
- Holds a 9" plate.

MDSPLT9 Color: White (148).
MDSPLT9 Sold in full cases only.

MDS9, MDSL9 and HK39B Colors:
Meadow (447), Wheat (457),
Speckled Gray (480), Cranberry (487),
Navy Blue (497), Black (110).



Camchiller® Pellet System

Keeps cold food below or at 40°F for up to 45 minutes when used with a chilled plate and insulated dome.



Camchiller® Pellet

- Shatter-resistant at freezing temperature.
- Stackable for easy transport and storage.
- Fits 9" plate, Cambro 9" plate cover and insulated dome.
- Can be used with or without an underliner.
- High-temperature dishwasher safe.

MDSPC9 Color: Black (110).

MDSPLT9 Color: White (148).
MDSPLT9 Sold in full cases only.

MDS9 and MDSL9 Colors:
Meadow (447), Wheat (457),
Speckled Gray (480), Cranberry (487),
Navy Blue (497), Black (110).













MEAL DELIVERY OPTIONS AND ACCESSORIES

Camduction® Complete Heat System

				
CODE	MDS09 	MDSL09 	MDSPL09	MDS09B 
DESCRIPTION	Insulated dome covers 9" plate	Low profile insulated dome covers 9" plate	Ceramic plate	Camduction base holds 9" plate
OUTSIDE DIAMETER	10¼"	10¼"	9"	9½"
OUTSIDE HEIGHT	3⅜"	2¾"	1"	1⅝"
FULL-SIZE CAMRACK®	PR59314	PR59314	PR314	PR59314
CASE PACK	12	12	24	12
LIST PRICE EACH	\$ 18.55	\$ 14.00	\$ 189.00 / case	\$ 95.00

Camtherm® Thermal Pellet System









						
CODE	MDS09 	MDSL09 	MDSPL09	MDSP9 	MDSL9 	MDSL
DESCRIPTION	Insulated dome covers 9" plate	Low profile insulated dome covers 9" plate	Ceramic plate	Thermal pellet holds 9" plate	Pellet underliner holds 9½" pellet	Camtherm thermal pellet lifter
OUTSIDE DIAMETER	10¼"	10¼"	9"	9½"	9½"	3⅜"
OUTSIDE HEIGHT	3⅜"	2¾"	1"	1¼"	1⅝"	3"
FULL-SIZE CAMRACK®	PR59314	PR59314	PR314	PR59314	PR59314	—
CASE PACK	12	12	24	12	12	1
LIST PRICE EACH	\$ 18.55	\$ 14.00	\$ 189.00 / case	\$ 43.35	\$ 8.40	\$ 81.90

Heat Keeper Insulating Base System

				
CODE	MDS09 	MDSL09 	MDSPL09	HK39B 
DESCRIPTION	Insulated dome covers 9" plate	Low profile insulated dome covers 9" plate	Ceramic plate	Insulating base holds 9" plate
OUTSIDE DIAMETER	10¼"	10¼"	9"	9⅝"
OUTSIDE HEIGHT	3⅜"	2¾"	1"	1⅝"
FULL-SIZE CAMRACK®	PR59314	PR59314	PR314	PR59314
CASE PACK	12	12	24	12
LIST PRICE EACH	\$ 18.55	\$ 14.00	\$ 189.00 / case	\$ 10.65

HK39B InStock Color: Black (110), Cranberry (487), Metallic Blue (489), Navy Blue (497).

Camchiller® Pellet System

					
CODE	MDS09 	909CW 	MDSPL09	New! MDSPC9 	MDSL9 
DESCRIPTION	Insulated dome covers 9" plate	Camwear Camcover®	Ceramic plate	Camchiller pellet holds 9" plate	Pellet underliner holds 9½" pellet
OUTSIDE DIAMETER	10¼"	10⅞"	9"	9½"	9½"
OVERALL HEIGHT	3⅜"	2¾"	1"	1⅝"	1⅝"
FULL-SIZE CAMRACK®	PR59314	PR59314	PR314	PR59314	PR59314
CASE PACK	12	12	24	12	12
LIST PRICE EACH	\$ 18.55	\$ 10.75	\$ 189.00 / case	\$ 30.00	\$ 8.40

DISPOSABLE CAMLIDS®

Disposable Lids for Shoreline



LID CODE	CLSM8B5	CLSB9	CLSSM8B5
DESCRIPTION	Sm. disp. lid	Lg. disp. lid	Disp. sip lid
FITS	MDSB5, MDSM8	MDSB9	MDSB5, MDSM8
OUTSIDE DIAMETER	3 ⁷ / ₁₆ "	4 ⁷ / ₁₆ "	3 ⁷ / ₁₆ "
HEIGHT	5 ¹ / ₁₆ "	5 ¹ / ₁₆ "	1 ¹ / ₁₆ "
CASE PACK	1,500	1,000	1,000
LIST PRICE PER CASE	\$ 97.65	\$ 81.90	\$ 81.90

CLSM8B5, CLSB9 Color: Translucent (190). CLSSM8B5 Color: White (148).
Sold in full cases only. No broken cartons.



The 6 & 9 ounce Lido tumblers are marked with 2 ounce increments from the top down for easy patient liquid intake recording.

Disposable Lids for Laguna® Tumblers



LID CODE	CLLT6	CLLT10	CLLT12
FITS TUMBLER	LT6	LT10	LT12
TUMBLER CAPACITY	6 oz.	10 oz.	12 oz.
CASE PACK	1,500	1,000	1,000
LIST PRICE PER CASE	\$ 110.25	\$ 89.25	\$ 97.75

Color: Translucent (190). Sold in full cases only. No broken cartons.

Disposable Lid for Swirl Bowls



LID CODE	CLSRB5
FITS SWIRL BOWLS	SRB5CW / SRB5
SWIRL BOWL CAPACITY	5 oz.
CASE PACK	1,000
LIST PRICE PER CASE	\$ 146.45

Color: Clear (152). Made of (P.E.T.).
Sold in full cases only. No broken cartons.

Disposable Lids for Colorware Tumblers



LID CODE	CLJ6	New! CL800P	CL900P	CL950P
FITS TUMBLERS	500P / 500P2	800P	900P / 900P2	950P / 950P2
TUMBLER CAPACITY	5.2 oz.	8 oz.	9.7 oz.	9.8 oz.
CASE PACK	1,000	1,000	1,000	1,000
LIST PRICE PER CASE	\$ 66.60	\$ 76.55	\$ 97.75	\$ 71.30

Color: Translucent (190). Sold in full cases only. No broken cartons.

Disposable Lids for Lido® Tumblers



LID CODE	CLST6	CL900P
FITS TUMBLERS	LDT6	LDT9
TUMBLER CAPACITY	6 oz.	9 oz.
CASE PACK	1,000	1,000
LIST PRICE PER CASE	\$ 69.60	\$ 97.75

Color: Translucent (190).
Sold in full cases only. No broken cartons.

Disposable Lids for Newport Tumblers



LID CODE	CLNT5	CLNT8	New! CLNT9	CLNT10	CLNT12
FITS TUMBLER	NT5	NT8	NT9	NT10	NT12
TUMBLER CAPACITY	6.4 oz.	8 oz.	9 oz.	10 oz.	12.6 oz.
CASE PACK	1,500	1,000	1,000	1,000	1,000
LIST PRICE PER CASE	\$ 110.25	\$ 69.60	\$ 97.75	\$ 89.25	\$ 97.75

Color: Translucent (190). Sold in full cases only. No broken cartons.

CAMDUCTION® COMPLETE HEAT SYSTEM – HOT MEAL DELIVERY SYSTEM

Camduction innovative hot meal delivery system is fast and efficient. Camduction is perfect for any facility with a hot tray line system. One charger can accommodate up to 300 meals per service.

Camduction Charger covered by U.S. Patent 8,263,906 B2.
Camduction Base covered by U.S. Patent D630,897 S.

Camduction Charger comes with 1 year warranty.

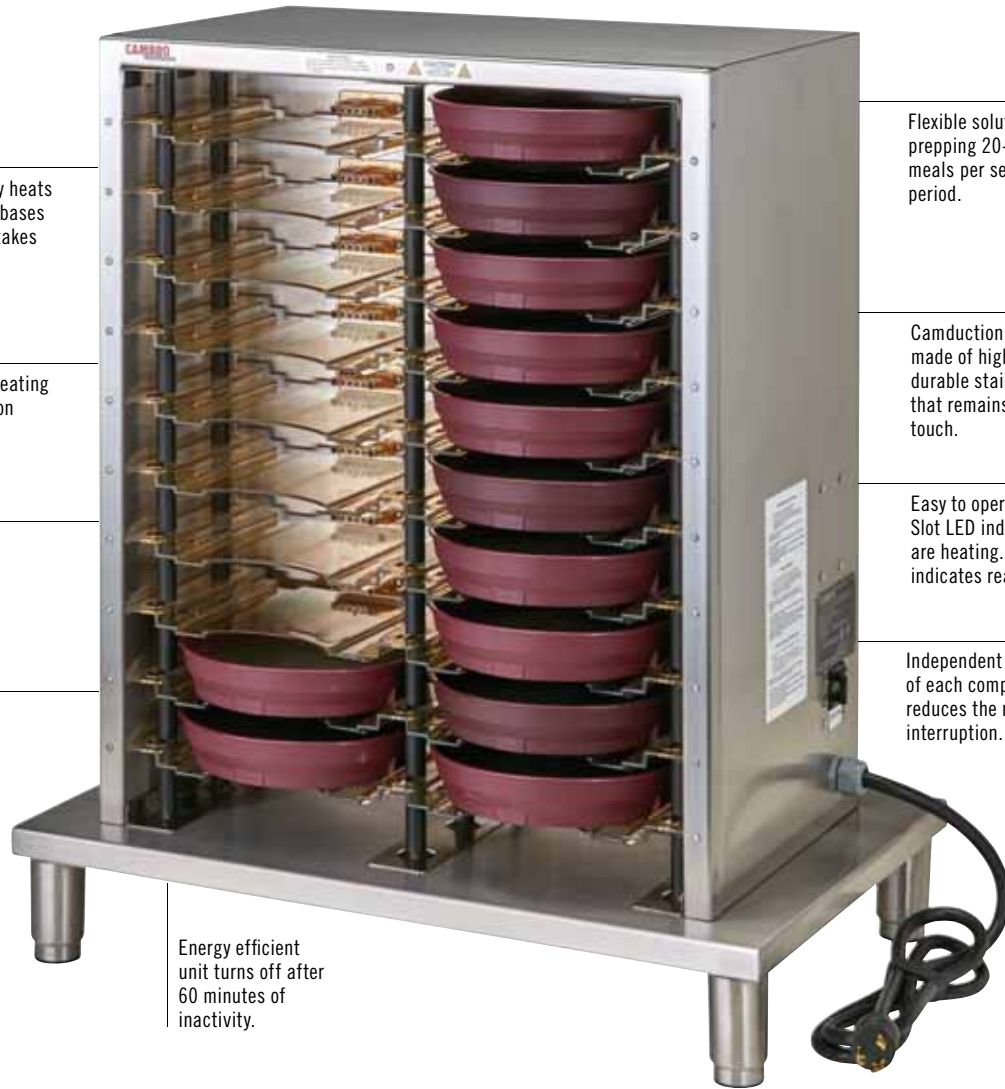

Quickly and efficiently heats up to 20 Camduction bases at one time. Heating takes 5 minutes.

Reliable, consistent heating of up to 20 Camduction bases at once.

Supports up to 5 trays per minute, improving operational efficiency.

Holds hot foods safe at 140°F or higher for 45 minutes*.

Energy efficient unit turns off after 60 minutes of inactivity.

Flexible solution for prepping 20-300 meals per service period.

Camduction charger is made of high-grade, durable stainless steel that remains cool to the touch.

Easy to operate: Red Slot LED indicates bases are heating. Green light indicates ready.

Independent functionality of each compartment reduces the risk of service interruption.

Base Charger

CODE	MDSCDC9X1
DESCRIPTION	Camduction base charger, single phase
CAPACITY	20 Bases
OVERALL DIMENSIONS W x D x H	30" x 18 ⁷ / ₈ " x 34 ⁵ / ₈ "
VOLTAGE / PHASE	208-240 VAC, Single Phase
AMPS / HERTZ	18, 50/60
PLUG CONFIGURATION	NEMA L6-30P
ELECTRICAL CORD	6 feet
INITIAL HEAT UP TIME	4 - 6 minutes*
ALL INDICATOR LIGHTS	LED
UNIT WEIGHT	108 lbs.
LIST PRICE EACH	\$ 8,500.00
Case Pack: 1 Color: Stainless Steel (000). *Based on voltage supply.	

Food Temperature Retention

Test performed with heated Cambro plate, dome, and Camduction Base.

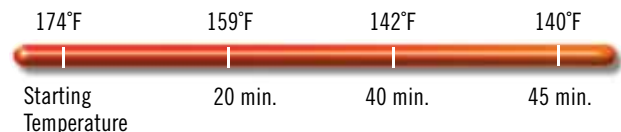

CAMTHERM® PLATE HEATER



- Heats plates up to proper temperatures to help keep foods hot longer, increase food quality and enhance patient satisfaction scores.
- Insulation keeps exterior cool to the touch.
- Delivers reliable and convected air heating throughout the unit.
- Self-leveling plate dispensers hold up to 100 plates.
- Fits ceramic or china plates up to 10.5" in diameter.
- Energy savings with independent temperature control for each silo.

Color: Stainless Steel (000).



CODE	CHPL100
DESCRIPTION	Plate heater
NUMBER OF SILOS	2
CAPACITY	100 plates (50 in each side)
DIMENSIONS W x D x H	39¾" x 26½" x 39⅞"
VOLTAGE/PHASE	208-240 VAC
AMPS / HERTZ	10.5 , 50/60
WATTS	2400
ELECTRICAL CORD	6 feet
NEMA PLUG CONFIGURATION	6-15
TEMPERATURE RANGE	80° - 175°F
PRODUCT WEIGHT	356 lbs.
LIST PRICE EACH	\$ 8,500.00

Case Pack: 1



CHPL100

REUSABLE CAMLIDS®



- Save up to 75% in lid costs each year.
- Reduce your waste-stream by tons each year when you switch from disposables to reusables.
- Dishwasher safe.
- Made of durable polypropylene.
- Fits both Shoreline and Harbor Collection mugs and bowls.



CAMRACK® WASH AND STORE RACK

- Designed for safe and secure washing and storing of reusable CamLids, CLRSB9 and CLRSM8B5 only.
- Holds 36 reusable CamLids.
- 2 Wash and store racks fit in a full size base rack.



Visit www.cambro.com/savemoney for a Customized Savings Calculator!

CODE	DESCRIPTION	DIMENSIONS	CASE PACK	LIST PRICE EA.
Reusable CamLids		H x DIA.		
CLRSM8B5	Fits 8 oz. mug and 5 oz. bowl	¾" x 3⅞"	240	\$ 119.00
CLRSB9	Fits 9 oz. bowl	¾" x 4⅞"	240	158.50
CLRSB16	Fits 16 oz. bowl	¾" x 5½"	240	260.00
Accessories for CLRSM8B5 and CLRSB9		L x W x H		
CLRWSR36	Camrack wash and store rack for reusable lids	8¼" x 17⅞" x 5½"	4	24.90
BR578	Camrack full size base rack with 2 extenders	19¾" x 19¾" x 7¼"	4	69.30
DRC2020	Full rack cover	19⅝" x 19⅝" x 1⅝"	1	55.55
Accessories for CLRSB16		L x W x H		
PR500	9 x 9 peg rack with 1 extender	19¾" x 19¾" x 5⅝"	5	56.90
E3	Full size open extender	19¾" x 19¾" x 2"	12	13.75
CRPHDG2878	Full size square hold down grid	18⅝" x 18⅝"	6	27.15

Reusable CamLids sold in full cases only. No broken cartons.

Reusable CamLids Color: Speckled White (490).

Camrack Wash and Store Rack Color: Kelly Green (452).

Camrack Base Full Size InStock Color: Soft Gray (151).

Full Rack Cover InStock Color: Gray (180).

CLRWSR36 is covered under U.S. patent D 617,069.

Full Rack Cover not NSF certified.



CAMSHELVING® HYGIENIC DRYING RACKS

- Keep tray line and warewashing areas organized and prevent wet stacking by storing newly washed products upright for faster drying before storing.
- Non-corrosive, break resistant and easy to assemble.
- Mobile racks allow for easy floor clean up and maneuverability.
- Drying Cradles are removable and available separately to convert existing units to Drying Racks.
- Lifetime warranty against rust and corrosion on posts and traverses.
- Drying Cradles are made of high impact ABS material.

***Camshelving Premium Series Color:** Speckled Gray (480).
****Camshelving Elements Series Color:** Brushed Graphite (580).
*****Drying Cradle Color:** Soft Gray (151).
Casters:
4 Premium Casters: (2 Swivel with Total Locking Brake, 2 Swivel with No Brake).



Vertical Drying Rack

- Securely holds various sizes of trays, cutting boards, baking sheet pans, lids and plates 8" to 13.5".
- Drying Cradles are installed directly onto shelf traverses.
- Fits 24" shelves.

7-Slot Drying Cradle is covered by U.S. Patent D 663,912 S.



CSDR7
7-Slot Drying Cradle
Width Per Slot: 1 1/16"



CPMU244875DRPKG
Camshelving Premium



EMU244878DRPKG
Camshelving Elements

CODE	DESCRIPTION	DIMENSIONS D x L x H	HOLDING CAPACITY	CASE PACK	LIST PRICE EA.
Camshelving Premium*					
CPMU244875DRPKG	Vertical drying rack	24" x 48" x 75"	84 trays	1	\$ 1,411.80
CPMU246075DRPKG	Vertical drying rack	24" x 60" x 75"	105 trays	1	1,626.30
Camshelving Elements**					
EMU244878DRPKG	Vertical drying rack	24" x 48" x 78"	84 trays	1	1,273.90
EMU246078DRPKG	Vertical drying rack	24" x 60" x 78"	105 trays	1	1,441.90
Drying Cradles***					
CSDR7	7-Slot drying cradle	23 1/2" x 10 1/4" x 3 3/4"		1	56.00
CSDR73	7-Slot drying cradle	23 1/2" x 10 1/4" x 3 3/4"		3	168.00 (Case price)

Drying Cradles fit on Camshelving Premium Series and Elements Series, mobile or stationary 24" deep shelves to 72" in length. **Package Includes:** Pre-assembled mobile post kits, 6 traverses for each model (Elements Series includes mobile dovetails), 12 or 15 drying cradles and premium swivel casters with total locking brake. Assembly required.

CAMSHELVING® HYGIENIC DRYING RACKS



Angled Drying Rack

- Securely holds up to 128 meal delivery Pellets/Bases or a variety of food pan sizes, pots and kitchen wares.
- Drying Cradles are installed directly onto shelf traverses.
- Fits 24" shelves.

*Camshelving Premium Series Color: Speckled Gray (480).
 **Camshelving Elements Series Color: Brushed Graphite (580).
 ***Drying Cradle Color: Soft Gray (151).

8-Slot Drying Cradle is covered by U.S. Patent D739,989 S.

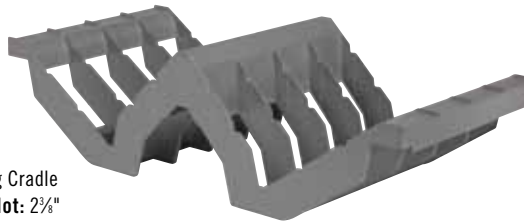

CSDR8
 8-Slot Drying Cradle
 Width Per Slot: 2 3/8"

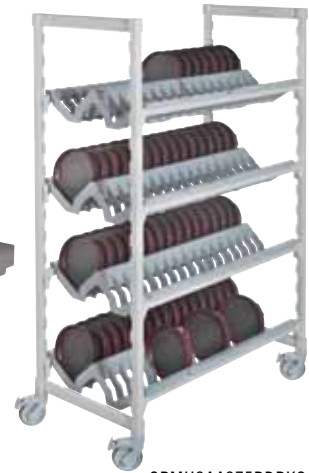

CPMU244875PDPKG
 Camshelving Premium

CODE	DESCRIPTION	DIMENSIONS D x L x H	HOLDING CAPACITY	CASE PACK	LIST PRICE EA.
Camshelving Premium*					
CPMU244875PDPKG	Angled drying rack	24" x 48" x 75"	128 pellets and bases or 16 GN 1/1 food pans	1	\$ 1,531.30
Camshelving Elements**					
EMU244878PDPKG	Angled drying rack	24" x 48" x 78"	128 pellets and bases or 16 GN 1/1 food pans	1	1,443.60
Drying Cradles***					
CSDR8	8-Slot drying cradle	23 1/16" x 10 3/8" x 6 1/16"		1	45.00
CSDR84	8-Slot drying cradle	23 1/16" x 10 3/8" x 6 1/16"		4	180.00 (Case price)

Individual Drying Cradles fit on Camshelving Premium, Elements and Basics Series 24" deep shelves only, mobile or stationary. **Package Includes:** Pre-assembled mobile post kits, 8 traverses for each model (Elements Series includes mobile dovetails), 16 drying cradles and premium swivel casters with total locking brake. Assembly required.



EMU244878PDPKG
 Camshelving Elements

Dome Drying Rack

- Securely holds 100 meal delivery domes.
- Drying Cradles are installed directly onto shelf traverses.
- Fits 21" shelves.

*Camshelving Premium Series Color: Speckled Gray (480).
 ***Drying Cradle Color: Soft Gray (151).

10-Slot Drying Cradle is covered by U.S. Patent D 736,488 S.



CSDDC
 10-Slot Drying Cradle
 Width Per Slot: 3 1/8"

CODE	DESCRIPTION	DIMENSIONS D x L x H	HOLDING CAPACITY	CASE PACK	LIST PRICE EA.
Camshelving Premium*					
CPMU213675DDPKG	Dome drying rack	21" x 36" x 75"	100 domes	1	\$ 1,234.70
Drying Cradles***					
CSDDC	10-slot drying cradle	20 1/2" x 16 1/8" x 3 3/8"		1	45.00
CSDDC5	10-slot drying cradle	20 1/2" x 16 1/8" x 3 3/8"		5	225.00 (Case price)

Individual Drying Cradles fit on Camshelving Premium and Camshelving Elements Series 21" deep shelves only, mobile or stationary. **Package Includes:** Pre-assembled mobile post kits, 10 traverses, 10 drying cradles and premium swivel casters with total locking brake. Assembly required.



CPMU213675DDPKG
 Camshelving® Premium

MEAL DELIVERY CARTS FOR TRAY SERVICE

- Transport meal trays from the kitchen to acute care patients, nursing home residents or correctional facility inmates.
- Enhance patient satisfaction with high quality, room service style meals served quietly and efficiently.
- Tough, one-piece, double-wall polyethylene carts are easy to clean and won't rust, dent, crack, chip or break.
- Non-electric and requires no assembly.
- Features light-weight non-insulated ABS doors.
- Features four total locking quiet, non-marking nylon casters (2 rigid, 2 swivel with brake). MDC1411T60 comes standard with plated casters.
- NSF Listed.

Single door 10-Tray Meal Delivery Cart is covered by U.S. Patent D 723,237 S.



10-TRAY DUAL ACCESS ROOM SERVICE CART – LOW PROFILE



Large, molded-in ergonomic handle makes it easy to transport and maneuver.

Molded-in marine rail provides an additional tray landing surface. Marine rail is designed for use during service, not transport.



Center opening provides self-venting airflow, optimizing food quality and humidity.

Polyurethane insulation ensures quiet meal delivery and provides structural strength.

Molded-in rails ensure quiet meal delivery, rail spacing 5 1/4" (13,34 cm).

Durable, lightweight, self-venting, ABS doors are non-insulated and open a full 270°, providing ergonomic access to trays from both the front and back of the cart.

Holds up to ten 15" x 20" (38 x 51 cm) trays.



Menu clip holds routing directions or content lists.

Molded-in full-perimeter bottom bumper protects the cart, walls and furniture.



Total locking quiet casters lock both swivel motion and wheel.



CODE	MDC1520S100
TRAY SIZE	15" x 20"
TRAYS PER COMPARTMENT/ RAIL SPACING	5 / 5 1/4"
EXTERNAL DIMENSIONS W x D x H	30 3/8" x 38 3/4" x 42 3/4"
INTERNAL DIMENSIONS W x D x H	21 1/8" x 31" x 26 1/4"
CASTER TYPE	Nylon, 5" 2 rigid, 2 swivel with brake
UNIT WEIGHT	91 lbs.
LIST PRICE EACH	\$ 3,540.00

Case Pack: 1 Colors: Granite Gray (191), Granite Sand (194).

AIRPOT AND CONDIMENT STATION

- Holds three airpots for safe transport and service.
- Compartments are designed for stir sticks, napkins and a variety of condiments.
- Stain and odor resistant.
- Made of durable ABS material.

BSACS patent pending.



CODE	DIMENSIONS W x D x H	CASE PACK	LIST PRICE EA.
BSACS	23¼" x 15½" x 6"	1	\$ 165.00

Color: Black (110). Airpots not included.

10-TRAY SINGLE DOOR ROOM SERVICE CART – LOW PROFILE



One louvered vent on the back supports air circulation to optimize food quality.

Large, molded-in ergonomic handle makes it easy to transport and maneuver.

Molded-in marine rail creates additional work surface during service. Marine rail is designed for use during service, not transport.



Molded-in rails ensure quiet meal delivery, rail spacing up to 5¼" (13,34 cm).

Molded-in full-perimeter bottom bumper protects the cart, walls & furniture.

Lightweight, self-venting, ABS door is non-insulated and opens a full 270°.

Total locking quiet casters lock both swivel motion and wheel.



Menu clip holds routing directions or content lists.

CODE	MDC1520S10	MDC1520S10HD
TRAY SIZE	15" x 20"	15" x 20"
TRAYS PER RAIL / RAIL SPACING	2 / 5¼"	2 / 5¼"
EXTERNAL DIMENSIONS W x D x H	30⅞" x 38¼" x 42¾"	30⅞" x 38½" x 43½"
INTERNAL DIMENSIONS W x D x H	21⅞" x 31" x 26¼"	21⅞" x 31" x 26¼"
CASTER TYPE	Nylon, standard casters 5" x 1¼"	Nylon, heavy duty casters 6" x 2"
UNIT WEIGHT	78 lbs.	90 lbs.
LIST PRICE EACH	\$ 2,585.00	\$ 3,020.00

Case Pack: 1 Colors: Granite Gray (191) and Granite Sand (194).

20-TRAY MEAL DELIVERY CART – LOW PROFILE



MDC1520S20
Back view with louvered vents.

Marine rail is designed for use during service, not transport.



CODE	MDC1520S20	MDC1418S20
TRAY SIZE	15" x 20"	14" x 18"
TRAYS PER CART / PER COMPARTMENT	20 / 10	20 / 10
RAILS PER COMPARTMENT	5	5
TRAYS PER RAIL / RAIL SPACING	2 / 5½"	2 / 5½"
NUMBER OF COMPARTMENTS AND VENTS	2	2
NUMBER OF MENU CLIPS	2	2
MENU CLIPS - LOCATION	1 per door	1 per door
HANDLES - TYPE AND LOCATION	Molded in, each end	Molded in, each end
CASTER TYPE	Nylon, 6", 2 swivel w/brakes, 2 rigid, offset	Nylon, 5", 2 swivel w/brake, 2 rigid, offset
LATCHES	2 internal nylon friction	2 internal nylon friction
EXTERNAL DIMENSIONS W x L x H	38" x 55½" x 44¼"	32½" x 48½" x 44"
INTERNAL DIMENSIONS W x D x H	20½" x 30¼" x 27½"	18⅝" x 28⅝" x 29"
REQUIRED DOOR WIDTH	38½"	33"
UNIT WEIGHT	155 lbs.	141.5 lbs.
LIST PRICE EACH	\$ 3,885.00	\$ 3,820.00

Case Pack: 1 Colors (All carts with cream color doors): Slate Blue (401), Granite Gray (191), Granite Green (192), Granite Sand (194).

16 AND 30 TRAY MEAL DELIVERY CARTS— TALL PROFILE



Marine rail is designed for use during service, not transport.



Tall Profile

CODE	MDC1520T30	MDC1418T30	MDC1520T16	MDC1418T16
TRAY SIZE	15" x 20"	14" x 18"	15" x 20"	14" x 18"
TRAYS PER CART / COMPARTMENT	30 / 10	30 / 10	16 / 8	16 / 8
RAILS PER COMPARTMENT	10	10	4	4
TRAYS PER RAIL / RAIL SPACING	1 / 5"	1 / 5"	2 / 5¼"	2 / 5¼"
NUMBER OF COMPARTMENTS	3	3	2	2
NUMBER OF MENU CLIPS	5	5	1	1
MENU CLIPS - LOCATION	Each door, each end	Each door, each end	Back of cart only	Back of cart only
HANDLES - TYPE AND LOCATION	Heavy-duty nylon, mounted 1 per end	Heavy-duty nylon, mounted 1 per end	Molded-in, back of cart	Molded-in, back of cart
CASTER TYPE	Nylon, 6", 2 rigid, 4 swivel with brake, offset	Nylon, 6", 2 rigid, 4 swivel with brake, offset	Nylon, 6", 2 rigid, 2 swivel with brake	Nylon, 6", 2 rigid, 2 swivel with brake
LATCHES	Friction catch, transit latches*	Friction catch, transit latches*	Large paddle latch	Large paddle latch
EXTERNAL DIMENSIONS W x L x H	29¼" x 60" x 63⅝"	29¼" x 60" x 63⅝"	30⅞" x 39⅞" x 58⅞"	28" x 36½" x 58⅞"
INTERNAL DIMENSIONS W x D x H	15¼" x 21" x 50"	14½" x 21½" x 50"	20⅞" x 30½" x 21½"	18⅞" x 29⅞" x 21½"
REQUIRED DOOR WIDTH	30"	30"	31"	28½"
UNIT WEIGHT	210 lbs.	214 lbs.	137.5 lbs.	121 lbs.
LIST PRICE EACH	\$ 6,235.00	\$ 6,175.00	\$ 3,585.00	\$ 3,495.00

Case Pack: 1 Cart Colors (All carts with cream color doors): Slate Blue (401), Granite Gray (191), Granite Green (192), Granite Sand (194). *Stainless steel transit latch at top of each door. MDC1520T16 and MDC1418T16 are covered by U.S. Patent D 398,727. For lighter-duty applications, 30-tray carts may be ordered without the steel transit latches by using product code MDC1520T30NL or MDC1418T30NL.

60-TRAY MEAL DELIVERY CART FOR CORRECTIONAL TRAY SERVICE

- For use in correctional facilities.
- Holds 60 each 1411CW or 1411CP Cambro Base Trays with 853 Insert Trays or 60 each 10146DCW or 10146DCP Separator Compartment Trays.
- Security features include security screws on handles, stop locks on door knuckles, security bolts for transit latches and caster carriage bolts with lock nuts.



CODE	MDC1411T60
TRAY SIZE	14" x 11" base tray 1411CW and 1411CP
TRAYS PER CART / PER COMPARTMENT	60 / 20
RAILS PER COMPARTMENT	10
TRAYS PER RAIL / RAIL SPACING	2 / 5"
NUMBER OF COMPARTMENTS	3
HANDLES - TYPE AND LOCATION	Heavy-duty aluminum with security screws, black finish, 1 per end
CASTER TYPE	Nylon, 6" heavy-duty casters, 2" wide tread, 2 swivel with brake, 2 rigid
LATCHES	Internal friction catch, 2 per door, transit latch*
EXTERNAL DIMENSIONS	W 29 ³ / ₄ " x L 60" x H 63 ⁵ / ₈ "
INTERNAL DIMENSIONS	W 14 ¹ / ₂ " x D 21 ¹ / ₂ " x H 50"
REQUIRED DOOR WIDTH	30"
UNIT WEIGHT	216 lbs.
LIST PRICE EACH	\$ 6,175.00

Case Pack: 1 Colors: Granite Gray (191), Granite Sand (194), Slate Blue (401).
*Stainless steel transit latch at top of each door.

MEAL DELIVERY CARTS FEATURES AND CASTER CONFIGURATIONS

Standard Caster Configurations:

These caster configurations are designed to provide stability and maneuverability over uneven surfaces.

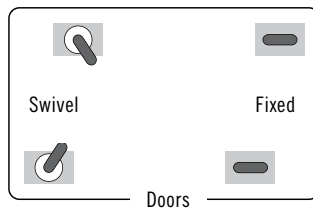

MDC1520S20, MDC1418S20, MDC1411T60

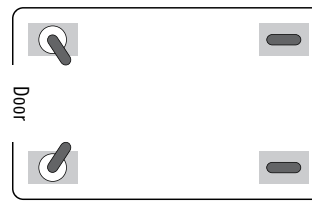

MDC1520S10*, MDC1520T16, MDC1418T16

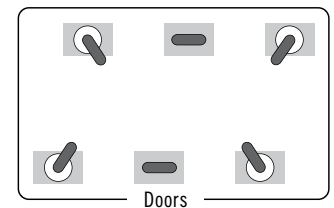

MDC1520T30, MDC1418T30

Optional Caster Configurations*:

These caster configuration options are alternative designs if facility or environment requires the need to change.

*All optional caster configurations are special order items and therefore non-returnable.

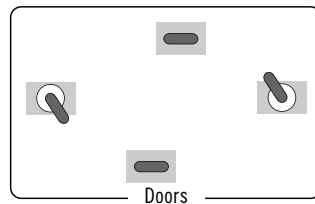

MDC1520S20, MDC1418S20

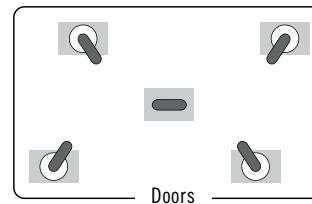

MDC1520S20, MDC1418S20, MDC1520T30, MDC1418T30, MDC1411T60

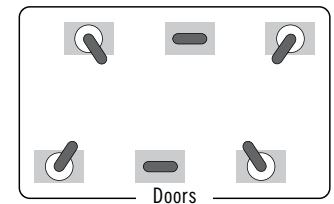

MDC1520S20, MDC1418S20, MDC1411T60

Handles

MDC1520S20, MDC1418S20



Molded in handles on each end of smooth transporting.

MDC1520T16, MDC1418T16



Molded in handles for easy transporting.

MDC1520T30, MDC1418T30, MDC1411T60**



Heavy duty nylon handles are securely mounted and nested into each end. **MDC1411T60 has tamper resistant heavy duty aluminum tubing handles.

LEAD IN CASTERS



Castors are offset to ease movement over uneven surfaces. This is standard on MDC1520S10, MDC1520S20, MDC1418S20, MDC1520T30, MDC1418T30 and MDC1411T60.

ALPHA NUMERICAL LISTING

Discontinued items effective 1/1/2018

CODE	PAGE	PRICE	CODE	PAGE	PRICE	CODE	PAGE	PRICE
1000	205	13.60	10HC258	72, 76	28.85	12189P	153	31.90
1000 (Group 3)	205	17.65	10HC414	72	47.90	1218CCW	152	14.90
1000CW	175	11.65	10HE1	77	15.25	1218CP	153	14.85
1000LCD	37	430.00	10HE2	77	14.30	1218DSCW	153	9.70
1000LCDCVR	37	130.00	10HPC	165	57.55	1218MT	216	20.30
1005CW	175	11.90	10HPCH	165	57.55	1218SCCW	54, 152	31.80
1007CW	175	11.90	10HPCHN	165	57.60	1219D	206	22.45
100BC	55	44.00	10HPD	163	42.45	1219D (Group 3)	206	29.00
100BC1	55	49.00	10HS1114	71	115.45	1220D	206	24.30
100BCS	55	65.00	10HS318	71	42.90	1220D (Group 3)	206	31.20
100CW	177	2.80	10HS434	71	58.65	1222D	206	24.30
100LCD	37, 39	235.00	10HS638	71	70.80	1222D (Group 3)	206	31.15
100MCCW	172	13.70	10HS800	71	85.65	1224MT	216	25.45
100MCCW441	173	15.05	10HS958	71	100.65	1230MT	216	29.55
100MPC	29	430.00	10PPCH	168	12.45	124VS	175	21.35
100MPCHL	28	540.00	10PPCWSC	159, 168	11.95	1252SLB250	154	350.20
100VS	175	13.65	10PPD	168	9.55	1252SLINB250	154	350.20
1010VS	175	14.90	1100	205	13.60	12CW	157	21.35
1012VS	175	14.90	1100 (Group 3)	205	17.20	12HP	163	64.10
1013CW	175	11.95	1100CT	212	18.75	12HP772	161	64.10
1014	204	16.00	1101CW	175	11.90	12HPH	166	73.70
1014 (Group 3)	204	20.70	1116	205	17.30	12RS12	55	203.00
10145CW	219	14.95	1116 (Group 3)	205	24.25	12SFSCW	144	26.45
10146CW	217, 219	13.70	1120CBP	86	18.05	12SFSCW441	173	29.10
10146DCP	220	9.00	1120CBR	86	24.05	12SFSP	145	18.90
10146DCPC	220	5.25	116VS	175	16.05	12SFSP	145	19.80
10146DCW	220	17.60	1200	205	15.00	12TGS	197	5.90
10146DCWC	220	9.35	1200 (Group 3)	205	20.10	1300	205	16.55
1014CL	216	14.55	1200CW	185	2.50	1300 (Group 3)	205	21.85
1014CT	212	23.10	1200DIV	26, 53	89.00	1313	206	16.55
1014FF	215	4.70	1200P	184	1.59	1313 (Group 3)	206	21.70
1014VS	175	14.90	1200P2	184	1.68	1318	204	22.95
1015	205	16.55	1202CW	175	11.95	1318 (Group 3)	204	28.65
1015 (Group 3)	205	21.40	120CWP	177	8.40	1318CC	21	530.00
1015MT	216	16.30	120VS	175	20.60	1318MT	216	20.85
10302MT	216	38.00	1210PW	26	200.15	1318MTC		Discontinued
1030MT	216	25.75	1216	204	18.50	13CLRCW	158	27.15
103VS	175	14.05	1216 (Group 3)	204	24.25	13CLRHP	164	77.55
105VS	175	14.05	1216CL	216	16.50	1400	205	16.85
106VS	175	15.75	1216CT	212	26.70	1400 (Group 3)	205	22.85
10CW	177	3.25	1216D	206	19.10	1400CT	212	24.95
10CWC	159	18.00	1216D (Group 3)	206	25.35	1400ET	211	27.45
10CWCH	159	18.00	1216FF	215	5.65	1400TL	213	15.00
10CWCHN	159	18.00	12183CW	152	24.10	14105CP	219	6.90
10CWD	157	15.50	12183P	153	19.35	14105CW	219	15.00
10CWGL	159	37.95	12186CW	152	30.50	1411CP	221	6.35
10CWL	177	2.50	12186P	153	24.15	1411CW	221	17.50
10CWNR	177	6.90	12189CW	54, 152	41.00	1418	173, 204	22.10

ALPHA NUMERICAL LISTING

Discontinued items effective 1/1/2018

CODE	PAGE	PRICE	CODE	PAGE	PRICE	CODE	PAGE	PRICE
1418 (Group 3)	204	28.80	1596CW	218	12.05	17HS318	71	44.70
14187TRCW	219	26.90	15CLRCW	158	32.95	17HS434	71	61.05
1418CL	216	18.80	15CLRHP	164	100.80	17HS638	71	77.00
1418CT	212	33.25	1600	205	21.15	17HS800	71	93.30
1418CW	210	24.95	1600 (Group 3)	205	28.30	17HS958	71	109.30
1418CWH	210, 225	34.55	1600CT	212	32.90	1800CT	212	46.65
1418CWNS	210, 225	39.25	1600CW	180, 185	3.10	1826	204	41.00
1418CWNSH	210, 225	40.60	1600DIV	26, 50	89.00	1826 (Group 3)	204	52.75
1418D	206	22.25	1600ET	211	36.20	182612CW	152	91.35
1418D (Group 3)	206	29.40	1600P	184	1.88	182612P	153	66.50
1418FF	215	7.25	1600P2	184	1.99	182615CW	152	107.80
1418H	206, 225	25.00	1600TL	213	20.00	182615P	153	78.25
1418TR	204	20.95	1621CBP	86	28.15	18263CW	152	44.00
1418TR (Group 3)	204	28.30	1621CBR		Discontinued	18263P	153	32.05
1418TRCW	210	24.95	1622	204	30.75	18266CW	152	57.00
1418VC (Group 3)	209, 224	39.25	1622 (Group 3)	204	40.00	18266P	153	42.05
1418VCH (Group 3)	209, 224	40.60	16225	204	33.70	18268CLRCW	153	81.55
1422TR	204	22.95	16225 (Group 3)	204	42.10	18268CLRKIT	153	209.95
1422TR (Group 3)	204	31.05	1622CT	212	46.65	18269CW	152	75.00
14CW	157	27.15	16C258	72, 76	40.45	18269P	153	54.85
14HP	163	77.55	16C414	72	56.35	1826CCW	152	29.85
14HP772	161	77.55	16C578	72	84.25	1826CL	216	30.90
14PP	168	16.80	16CW	54, 157	32.95	1826CLRCW	153	47.15
150CW	177	4.45	16E1	76	18.15	1826CP	153	24.70
1520	204	26.70	16E2	76	16.10	1826CT	212	56.00
1520 (Group 3)	204	34.65	16E4	77	19.45	1826DBC	20	2,535.00
1520CBCP	86	15.10	16E5	77	17.15	1826DBCSP	20	3,205.00
1520CBP	86	18.60	16HP	163	100.80	1826DSCW	153	24.55
1520CBPF	86	18.60	16HP772	161	100.80	1826DTC	20	2,535.00
1520CBR	86	24.60	16PP	168	21.50	1826DTCSP	20	3,225.00
1520CL	216	21.50	16S1058	67	126.80	1826HAR	21, 41	90.00
1520CT	212	37.80	16S1114	67	145.40	1826LBC	21	1,520.00
1520CW	210	25.95	16S1214	67	147.15	1826LBCSP	21	1,890.00
1520CWH	210, 225	38.65	16S318	67	56.90	1826LTC	21	1,535.00
1520CWNS	210, 225	43.90	16S418	67	59.60	1826LTC3	21	1,535.00
1520CWNSH	210, 225	46.20	16S434	67	74.55	1826LTCSP	21	1,920.00
1520D	206	26.45	16S534	67	76.35	1826MT	199, 216	33.25
1520D (Group 3)	206	33.45	16S638	67	89.50	1826MTC	21	795.00
1520H	206, 225	29.75	16S738	67	91.35	1826SCCW	152	53.45
1520TR	204	24.45	16S800	67	108.05	18CW	157	39.35
1520TR (Group 3)	204	31.95	16S900	67	110.00	18PP	168	28.90
1520VC (Group 3)	209, 224	43.90	16S958	67	124.85	18SFSCW	144	39.25
1520VCRST (Group 3)	209, 224	46.20	1722CBCP	86	27.20	18SFSCW441	173	43.20
1525RST	211	32.40	1722CBP	86	22.60	18SFSP	145	25.55
1550	205	21.55	1722CBR	86	31.95	18SFSP	145	26.95
1550 (Group 3)	205	28.10	17HE1	77	15.85	1950	205	29.20
1550CT	212	33.90	17HE2	77	15.25	1950 (Group 3)	205	38.50
1596CP	218	6.80	17HS1114	71	124.85	1950CT	212	47.75

ALPHA NUMERICAL LISTING

Discontinued items effective 1/1/2018

CODE	PAGE	PRICE	CODE	PAGE	PRICE	CODE	PAGE	PRICE
2000P	184	2.32	2115CBCP	86	15.05	25S738	68	97.70
2000P2	184	2.53	2115CBCR	86	15.00	25S800	68	108.05
200BC	55	60.00	22CW	157	11.85	25S900	68	117.40
200BC1	55	65.00	22HP	163	31.95	25S958	68	124.85
200BCS	55	75.00	22HP772	161	31.95	25SWGf	73, 184	88.25
200MCCW	172	18.90	22LPCW	157	16.20	26CF	169	59.85
200MCCW441	173	20.80	22LPHP	163	45.60	26CW	157	18.95
2025	204	50.00	22SFSCW	144	49.75	26HP	163	53.25
2025 (Group 3)	204	60.85	22SFSCW441	173	54.75	26HP772	161	53.25
2025MT	216	43.50	22SFSP	145	31.20	26PP	168	13.05
2030UT	81	750.00	22SFSP	145	33.20	2700	205	46.55
20C258	72, 76	41.95	23CLRCW	158	14.75	2700 (Group 3)	205	61.65
20C414	72	57.70	23CLRHP	164	41.55	2700CT	212	66.85
20CC	184	2.74	23SL	154	381.10	28CW	157	24.10
20CFC	169	15.15	23SLB250	154	705.55	2900CT	212	75.85
20CWC	159	9.40	23SLB250AF		Discontinued	2SFSCW	144	8.55
20CWCH	159	9.40	23SLB6250	154	183.35	2SFSCW441	173	9.40
20CWCHN	159	11.00	23SLINB250	154	705.55	2SFSP	145	6.60
20CWD	157	7.20	240MPC	28	300.00	2SFSP	145	6.95
20CWGL	159	26.35	2436UTH	81	705.00	300DIV	26	78.00
20CWL	159	14.85	2436UTHS	81	750.00	300MPC		Discontinued
20CWLN	159	14.85	24CW	157	14.75	30CFC	169	12.65
20E2	76	14.90	24HP	163	41.55	30CWC	159	6.90
20GE1	76	19.15	24HP772	161	41.55	30CWCH	159	6.90
20GE2	76	16.60	24LPCW	54, 157	20.20	30CWCHN	159	9.40
20HPC	165	25.05	24LPHP	163	56.70	30CWD	157	6.65
20HPCH	165	26.55	24PP	168	10.05	30CWGL	159	18.15
20HPCHN	165	30.45	2500	205	39.95	30CWL	159	12.70
20HPD	163	19.05	2500 (Group 3)	205	52.75	30CWLN	159	12.70
20HPL	165	44.10	2500CT	212	59.40	30GE1	76	19.45
20HPLN	165	44.10	250LCD	37	245.00	30GE2	76	17.50
20LPCWC	159	13.80	250LCDCVR	37	130.00	30HPC	165	18.70
20LPCWD	157	8.05	25CLRCW	158	18.95	30HPCH	165	21.10
20LPHPC	165	34.35	25CLRHP	164	53.25	30HPCHN	165	21.10
20LPHPD	163	21.20	25E1	76	19.15	30HPD	163	14.30
20PPCH	168	8.55	25E2	76	16.60	30HPL	165	31.50
20PPCWSC	159, 168	7.30	25E4	77	22.25	30HPLN	165	31.50
20PPD	168	4.95	25E5	77	18.65	30PPCH	168	5.90
20S1114	68	145.40	25MCCW	172	6.55	30PPCHN	168	7.30
20S318	68	56.90	25MCCW441	173	7.20	30PPCWSC	159, 168	5.50
20S434	68	75.50	25S1058	68	136.00	30PPD	168	4.60
20S638	68	90.30	25S1114	68	145.40	30S1114	68	145.40
20S800	68	108.05	25S1214	68	156.45	30S318	68	59.60
20S958	68	124.85	25S318	68	56.90	30S434	68	76.35
21155CBP	86	20.95	25S418	68	61.55	30S638	68	92.10
21155CBR	86	28.85	25S434	68	75.50	30S800	68	110.00
21157CBP	86	22.60	25S534	68	79.20	30S958	68	128.60
21157CBR	86	33.25	25S638	68	90.30	3200P2	184	3.77

ALPHA NUMERICAL LISTING

Discontinued items effective 1/1/2018

CODE	PAGE	PRICE	CODE	PAGE	PRICE	CODE	PAGE	PRICE
3253CL	216	18.55	40CWCH	159	6.25	55CWNR	177	2.75
3253CT	212	38.90	40CWCHN	159	6.25	57	204	5.50
32CC	184	4.13	40CWD	157	5.55	57 (Group 3)	204	7.70
32CW	157	8.90	40HPC	165	15.20	5FBRTT	47	1,655.00
32HP	163	26.75	40HPCH	165	16.35	60CFC	169	6.75
32HP1H	166	41.00	40HPCHN	165	16.55	60CW	177	3.25
32HP2H	166	42.00	40HPD	163	14.30	60CWC	159	4.90
32HP772	161	26.75	40PPCH	168	5.75	60CWCH	159	5.40
32PP	168	6.10	40PPCWSC	159, 168	4.85	60CWCHN	159	5.40
33CLRCW	158	12.25	40PPD	168	3.85	60CWD	157	2.95
33CLRHP	164	34.65	415CBP	86	8.30	60CWGL	159	14.90
33CLRPP	167	8.30	42CW	157	9.00	60CWL	159	7.20
34CW	157	12.25	42HP	163	23.15	60CWLN	159	7.20
34HP	163	34.65	42HP772	161	23.15	60HPC	165	13.25
34HP772	161	34.65	42PP	168	6.10	60HPCH	165	13.25
34PP	168	8.30	44CW	157	10.60	60HPCHN	165	13.25
350LCD	37	240.00	44HP	163	28.60	60HPD	163	7.35
35CLRCW	158	14.30	44HP772	161	28.60	60HPL	165	18.05
35CLRHP	164	47.15	44PP	168	7.20	60HPLN	165	18.05
35CLRPP	167	9.60	45CW	177	2.75	60PPCH	168	5.00
35CW	177	2.25	46	204	5.10	60PPCHN	168	5.45
36CF	169	45.00	46 (Group 3)	204	7.10	60PPCWSC	159, 168	3.75
36CW	157	14.30	46CW	157	12.25	60PPD	168	2.55
36E1	76	19.45	46HP	163	36.65	62CW	157	6.55
36E2	77	17.50	46HP772	161	36.65	62HP	163	18.10
36E4	77	25.15	46PP	168	8.30	62HP772	161	18.10
36E5	77	19.45	49E1	76	19.45	62PP	168	4.70
36HP	163	47.15	49E2	77	17.50	6302MT	216	32.30
36HP772	161	47.15	49S1114	69	150.95	630MT	216	20.60
36PP	168	9.60	49S318	69	60.55	63CLRCW	158	7.40
36S1058	69	140.70	49S434	69	78.20	63CLRHP	164	21.85
36S1114	69	145.40	49S638	69	94.10	63CLRPP	167	5.35
36S1214	69	159.45	49S800	69	110.00	64CW	157	7.40
36S318	69	59.60	49S958	69	130.45	64HP	163	21.85
36S418	69	64.25	4FBRTT	47	1,500.00	64HP772	161	21.85
36S434	69	76.35	4SFSCW	144	13.05	64PP	168	5.35
36S534	69	82.90	4SFSCW441	173	14.35	650WS	58	66.00
36S638	69	92.10	4SFSP	145	9.00	65CLRCW	158	9.90
36S738	69	102.40	4SFSP	145	9.55	65CLRHP	164	26.50
36S800	69	110.00	500CW	185	1.55	65CLRPP	167	6.05
36S900	69	122.10	500LCD	37	280.00	65CWNR	177	3.25
36S958	69	128.60	500LCDCVR	37	130.00	66CF	169	30.65
38CW	157	18.30	500P	180, 184	1.02	66CW	157	9.90
400DIV	26	78.00	500P2	180, 184	1.09	66HP	163	26.50
400MCCW	172	20.50	50CW	177	3.25	66HP772	161	26.50
400MCCW441	173	22.85	50MCCW	172	12.20	66PP	168	7.00
400STP	17, 22, 23, 41	15.00	50MCCW441	173	13.40	68VS	175	11.35
40CWC	159	6.25	5412CBP	39, 55	9.95	6F	194	12.25

ALPHA NUMERICAL LISTING

Discontinued items effective 1/1/2018

CODE	PAGE	PRICE	CODE	PAGE	PRICE	CODE	PAGE	PRICE
6FBRTT	47	1,785.00	86HP772	161	25.85	912CBP	86	11.30
6RS6	55	147.00	86VS	175	12.55	913MT	216	18.00
6SFSCW	144	16.90	8F	194	14.25	913VS	175	13.40
6SFSCW441	173	18.60	8FB434	75	47.55	915	204	17.25
6SFSP	145	11.20	8FBNH434	75	27.90	915 (Group 3)	204	20.00
6SFSPPP	145	11.85	8HC258	72	28.85	915CP	218	6.80
6TGS	197	2.50	8HC258	76	28.85	915CW	218	12.05
725CWNR	177	4.45	8HC414	72	47.90	918MT	216	19.55
730SR	58	105.00	8HE1	77	15.25	91VS	175	13.40
730STP	53	26.00	8HE2	77	13.70	926	204	22.55
730WS	58	46.00	8HS1114	71	115.45	926 (Group 3)	204	29.20
75CW	177	4.25	8HS318	71	42.90	92615MT	216	21.70
800CW	185	1.90	8HS434	71	58.65	926MT	216	21.75
800P	180, 184	1.23	8HS638	71	70.80	92CW	157	6.65
800P2	184	1.32	8HS800	71	85.65	92HP	163	13.70
806CW	175	9.75	8HS958	71	100.65	92HP772	161	13.70
80CWC	159	5.20	8RS8	55	164.00	92PP	168	4.95
80CWCH	159	5.70	8SFSCW	144	19.85	93CW	177	7.30
80CWCHN	159	5.70	8SFSCW441	173	21.85	94CW	157	8.10
80CWD	157	2.60	8SFSP	145	13.25	94HP	163	16.00
80HPC	165	11.15	8SFSPPP	145	14.05	94HP772	161	16.00
80HPCH	165	11.15	900	205	12.30	94PP	168	6.05
80HPCHN	165	11.15	900 (Group 3)	205	15.60	950CW	180, 185	2.20
80HPD	163	6.45	900CT	212	18.75	950P	180, 184	1.43
80PPCWSC	159	3.60	900CW	175	9.85	950P2	180, 184	1.55
810	204	12.15	900P	180,184	2.07	95VS	175	13.40
810 (Group 3)	204	15.70	900P2	180,184	2.26	96CW	177	4.25
825CWNR	177	5.20	9011CW	175	11.70	96PCW	157	10.15
8262MT	216	26.45	9013CW	175	11.70	96PHP	163	22.75
826MT	216	16.85	901CW	175	10.50	96SKRC	198	5.70
82CW	157	6.60	905CW	175	10.80	96SKRD	198	5.70
82HP	163	15.85	909CW	175, 229	10.75	96SKRF		Discontinued
82HP772	161	15.85	90CWC	159	5.50	96SKRLC	198	0.95
8302MT	216	35.55	90CWCN	159	5.50	96SKRLD	198	0.95
830MT	216	23.25	90CWD	157	2.25	96SKRLF		Discontinued
84CW	157	7.75	90HPC	165	9.10	96SKRLM	198	0.95
84HP	163	20.05	90HPD	161, 163	5.45	96SKRLP	198	0.95
84HP772	161	20.05	90PPC	168	4.30	96SKRM	198	5.70
850CW	185	4.85	90PPCWSC	159, 168	3.35	96SKRP	198	5.70
853FCP	221	5.65	90PPD	168	1.75	978SFVS	175	13.65
853FCPC	221	3.00	90SPCW	177	7.35	99VS	175	13.40
853FCW	221	11.35	9113CP	220	7.05	9CWNR	177	5.00
853FCWC	221	6.00	9113CW	220	16.05	9E1	76	17.10
853FH	221	22.85	9114CP	220	7.05	9E2	76	16.10
853FHC	221	13.15	9114CW	220	16.75	9RS9	55	179.00
85SFVS	175	13.40	911CPC	220	3.85	9S1114	67	145.40
86CW	157	10.25	911CWC	220	11.35	9S318	67	56.90
86HP	163	25.85	911VS	175	13.80	9S434	67	74.20

ALPHA NUMERICAL LISTING

Discontinued items effective 1/1/2018

CODE	PAGE	PRICE	CODE	PAGE	PRICE	CODE	PAGE	PRICE
9S638	67	88.55	BC340KDP	87	80.00	CBA215464V4	132	453.45
9S800	67	107.70	BCT1014	217	10.35	CBA215472V4	132	454.90
9S958	67	124.85	BR258	74, 76	37.15	CBA215484V5	133	561.70
9TGS	197	3.90	BR414	74	54.10	CBA216064V4	132	488.25
ADCS	83	1,330.00	BR578	74, 232	69.30	CBA216072V4	132	489.70
BAR540	63	2,635.00	BR712	74	85.10	CBA216084V5	133	605.20
BAR540DS	63	3,345.00	BSACS	236	165.00	CBA243064V4	132	308.60
BAR54SR	58	72.00	BSB10	194	11.95	CBA243072V4	132	310.10
BAR650	63	5,140.00	BSB12	194	15.40	CBA243084V5	133	380.55
BAR650CP	63	7,570.00	BSB18	194	32.45	CBA243664V4	132	342.20
BAR650DS	63	6,935.00	BUF48	47	440.00	CBA243672V4	132	343.70
BAR650DSCP	63	9,770.00	BUF72	47	510.00	CBA243684V5	133	422.55
BAR650SDX	62	11,240.00	BV6CW	187	3.50	CBA244264V4	132	387.60
BAR650SPM	62	15,305.00	BWB16CW	179	11.55	CBA244272V4	132	389.10
BAR650SPMT	62	17,250.00	BWM10CW	179	11.10	CBA244284V5	133	479.30
BAR650SPMT2	62	17,365.00	BWP14CW	179	12.05	CBA244864V4	132	417.60
BAR650DX	62	9,305.00	BWW10CW	179	8.75	CBA244872V4	132	419.10
BAR650PM	62	13,875.00	CB1220	14, 50, 51, 53	42.00	CBA244884V5	133	516.80
BAR650PMT	62	15,205.00	CBA183064V4	132	266.95	CBA245464V4	132	460.20
BAR650PMT220	62	15,660.00	CBA183072V4	132	268.45	CBA245472V4	132	461.70
BAR730	61	6,020.00	CBA183084V5	133	329.10	CBA245484V5	133	570.05
BAR730CP	61	8,595.00	CBA183664V4	132	299.75	CBA246064V4	132	491.80
BAR730DS	61	8,095.00	CBA183672V4	132	301.25	CBA246072V4	132	493.30
BAR730DSCP	61	12,130.00	CBA183684V5	133	370.10	CBA246084V5	133	609.55
BAR730SDX	60	13,305.00	CBA184264V4	132	344.95	CBCC1	135	5.50
BAR730DSM	60	16,840.00	CBA184272V4	132	346.45	CBCC10	135	55.00
BAR730DSPMT	60	18,960.00	CBA184284V5	133	426.60	CBCC8	135	44.00
BAR730DSPMT2	60	19,080.00	CBA184864V4	132	361.15	CBDS18H10	134	50.45
BAR730DX	60	9,950.00	CBA184872V4	132	362.65	CBDS18H6	134	50.25
BAR730PM	60	14,920.00	CBA184884V5	133	446.85	CBDS21H10	134	51.80
BAR730PMT	60	16,310.00	CBA185464V4	132	405.95	CBDS21H6	134	51.60
BAR730PMT220	60	16,430.00	CBA185472V4	132	407.45	CBDS24H10	134	53.00
BBR480	47	835.00	CBA185484V5	133	502.85	CBDS24H6	134	52.80
BBR720	47	990.00	CBA186064V4	132	436.55	CBID6	135	2.80
BC1115SH	88	80.00	CBA186072V4	132	438.05	CBTR30	134	24.50
BC11TC	88	90.00	CBA186084V5	133	541.10	CBTR36	134	24.70
BC225	88	605.00	CBA213064V4	132	293.25	CBTR42	134	27.40
BC2254S	88	625.00	CBA213072V4	132	294.70	CBTR48	134	30.00
BC230	88	765.00	CBA213084V5	133	361.45	CBTR54	134	32.65
BC2304S	88	785.00	CBA213664V4	132	331.85	CBTR60	134	35.20
BC235	88	830.00	CBA213672V4	132	333.30	CBU183064V4	132	334.30
BC2354S	88	850.00	CBA213684V5	133	409.70	CBU183072V4	132	337.30
BC330	88	825.00	CBA214264V4	132	382.85	CBU183084V5	133	408.70
BC3304S	88	845.00	CBA214272V4	132	384.30	CBU183664V4	132	367.10
BC331KD	87	196.00	CBA214284V5	133	473.45	CBU183672V4	132	370.10
BC331KDSH	87	46.00	CBA214864V4	132	402.05	CBU183684V5	133	449.70
BC331KDTC	87	80.00	CBA214872V4	132	403.50	CBU184264V4	132	412.30
BC340KD	87	292.00	CBA214884V5	133	497.45	CBU184272V4	132	415.30

ALPHA NUMERICAL LISTING

Discontinued items effective 1/1/2018

CODE	PAGE	PRICE	CODE	PAGE	PRICE	CODE	PAGE	PRICE
CBU184284V5	133	506.20	CCP15	195	15.40	CECMT6	79	1.85
CBU184864V4	132	428.50	CCP27	195	16.40	CECOF6	79	1.85
CBU184872V4	132	431.50	CCPL12	195	1.40	CECPI6	79	1.85
CBU184884V5	133	526.45	CCPL27	195	1.45	CECPO6	79	1.85
CBU185464V4	132	473.30	CD100	41	325.00	CECRF6	79	1.85
CBU185472V4	132	476.30	CD100H	40	520.00	CECRT6	79	1.85
CBU185484V5	133	582.45	CD100HB	40	630.00	CECRW6	79	1.85
CBU186064V4	132	503.90	CD1313	81	275.00	CECSB6	79	1.85
CBU186072V4	132	506.90	CD1327	81	295.00	CECSG6	79	1.85
CBU186084V5	133	620.70	CD1420	41, 81	295.00	CECSH6	79	1.85
CBU213064V4	132	362.30	CD160	41	325.00	CECWF6	79	1.85
CBU213072V4	132	365.20	CD1826H	40, 80	550.00	CECWI6	79	1.85
CBU213084V5	133	442.65	CD1826HB	40, 80	680.00	CECWT6	79	1.85
CBU213664V4	132	400.90	CD1826MTC	40	600.00	CECWW6	79	1.85
CBU213672V4	132	403.80	CD1826MTCHB	40	755.00	CFPFRC10	169	37.50
CBU213684V5	133	490.90	CD1826PDB	170	365.00	CFPMRC10	169	37.85
CBU214264V4	132	451.90	CD2020	41, 80	300.00	CFPSRC10	169	15.90
CBU214272V4	132	454.80	CD2020H	40, 80	470.00	CFR18	169	33.25
CBU214284V5	133	554.65	CD2020HB	40, 80	605.00	CFRC18	169	18.50
CBU214864V4	132	471.10	CD2028	41, 81	310.00	CFRSC18	169	5.50
CBU214872V4	132	474.00	CD300	24, 41	325.00	CHPL100	232	8,500.00
CBU214884V5	133	578.65	CD300H	24, 40	510.00	CJ80CW	198	8.25
CBU215464V4	132	522.50	CD300HB	40	605.00	CL800P	180, 230	76.55
CBU215472V4	132	525.40	CD3253EPP	32	140.00	CL900P	180, 230	97.75
CBU215484V5	133	642.90	CD400	17, 22, 23, 41	360.00	CL950P	180, 230	71.30
CBU216064V4	132	557.30	CDR2020	73, 80	175.00	CLAM8B5	180	99.10
CBU216072V4	132	560.20	CDR2020H	73	280.00	CLJ6	180, 230	66.60
CBU216084V5	133	686.40	CECBE6	79	1.85	CLLT10	180, 230	89.25
CBU243064V4	132	378.20	CECBL6	79	1.60	CLLT12	180, 230	97.75
CBU243072V4	132	381.20	CECBM6	79	1.85	CLLT6	180, 230	110.25
CBU243084V5	133	462.35	CECBR6	79	1.85	CLLT8	180	141.75
CBU243664V4	132	411.80	CECCF6	79	1.85	CLNT10	180, 230	89.25
CBU243672V4	132	414.80	CECCH6	79	1.85	CLNT12	180, 230	97.75
CBU243684V5	133	504.35	CECCL6	79	1.85	CLNT5	180, 230	110.25
CBU244264V4	132	457.20	CECCM6	79	1.85	CLNT8	180, 230	69.60
CBU244272V4	132	460.20	CECCO6	79	1.85	CLNT9	180, 230	97.75
CBU244284V5	133	561.10	CECCP6	79	1.85	CLRSB16	232	260.00
CBU244864V4	132	487.20	CECCR6	79	1.85	CLRSB9	232	158.50
CBU244872V4	132	490.20	CECDC6	79	1.85	CLRSM8B5	232	119.00
CBU244884V5	133	598.60	CECFL6	79	1.85	CLRWSR36	232	24.90
CBU245464V4	132	529.80	CECGO6	79	1.85	CLSB9	230	81.90
CBU245472V4	132	532.80	CECGR6	79	1.85	CLSM8B5	180, 230	97.65
CBU245484V5	133	651.85	CECHB6	79	1.85	CLSRB5	186, 230	146.45
CBU246064V4	132	561.40	CECHU6	79	1.85	CLSSM8B5	230	81.90
CBU246072V4	132	564.40	CECIC6	79	1.85	CLST6	180, 230	69.60
CBU246084V5	133	691.35	CECIT6	79	1.85	CLST9	180	97.75
CC32	171	620.00	CECJU6	79	1.85	CMBH1826LC	14	6,265.00
CCP12	195	9.85	CECMG6	79	1.85	CMBH1826LF	14	6,265.00

ALPHA NUMERICAL LISTING

Discontinued items effective 1/1/2018

CODE	PAGE	PRICE	CODE	PAGE	PRICE	CODE	PAGE	PRICE
CMBH1826LSP	14	6,560.00	CPA183084V5PKG	105	555.85	CPA243084V5PKG	105	624.60
CMBH1826TBC	14	9,785.00	CPA183664V4	104	487.25	CPA243664V4	104	555.55
CMBH1826TBF	14	9,785.00	CPA183672V4	104	489.70	CPA243672V4	104	558.15
CMBH1826TSC	14	9,785.00	CPA183684V5PKG	105	601.35	CPA243684V5PKG	105	685.85
CMBH1826TSF	14	9,785.00	CPA184264V4	104	560.05	CPA244264V4	104	628.95
CMBH1826TSP	14	10,325.00	CPA184272V4	104	562.50	CPA244272V4	104	631.55
CMBHC1826LC	14	14,765.00	CPA184284V5PKG	105	692.35	CPA244284V5PKG	105	777.60
CMBHC1826LF	14	14,765.00	CPA184864V4	104	586.25	CPA244864V4	104	677.75
CMBHC1826LSP	14	15,105.00	CPA184872V4	104	588.70	CPA244872V4	104	680.35
CMBHC1826TBC	14	20,740.00	CPA184884V5PKG	105	725.10	CPA244884V5PKG	105	838.60
CMBHC1826TBF	14	20,740.00	CPA185464V4	104	658.45	CPA245464V4	104	746.35
CMBHC1826TSC	14	20,740.00	CPA185472V4	104	660.90	CPA245472V4	104	748.95
CMBHC1826TSF	14	20,740.00	CPA185484V5PKG	105	815.35	CPA245484V5PKG	105	924.35
CMBHC1826TSP	14	21,315.00	CPA186064V4	104	708.05	CPA246064V4	104	797.15
CMBP		Discontinued	CPA186072V4	104	710.50	CPA246072V4	104	799.75
CMBPH		Discontinued	CPA186084V5PKG	105	877.35	CPA246084V5PKG	105	987.85
CMBPHD		Discontinued	CPA187264V4PKG	104	804.85	CPA247264V4PKG	104	918.35
CMBPHHD		Discontinued	CPA187272V4PKG	104	807.30	CPA247272V4PKG	104	920.95
CMBPL		Discontinued	CPA187284V5PKG	105	998.35	CPA247284V5PKG	105	1,139.35
CMBPLH		Discontinued	CPA212464V4	104	421.75	CPB1220	46	190.00
CMBPLH2		Discontinued	CPA212472V4	104	424.05	CPCC1	107	5.40
CMBPLH2HD		Discontinued	CPA212484V5PKG	105	518.55	CPCC10	107	54.00
CMBPLHD		Discontinued	CPA213064V4	104	495.35	CPCC8	107	43.20
CMBPLHHD		Discontinued	CPA213072V4	104	497.65	CPDS14H11	107	77.00
CMBPLHSP		Discontinued	CPA213084V5PKG	105	610.55	CPDS14H6	107	71.10
CMBPLHSPHD		Discontinued	CPA213664V4	104	538.75	CPDS18H11	107	79.35
CMBPLSP		Discontinued	CPA213672V4	104	541.05	CPDS18H6	107	73.45
CMBPLSPHD		Discontinued	CPA213684V5PKG	105	664.80	CPDS21H11	107	81.20
CMBPR1		Discontinued	CPA214264V4	104	621.55	CPDS21H6	107	75.30
CMBPR7		Discontinued	CPA214272V4	104	623.85	CPDS24H11	107	83.10
CMBPSP		Discontinued	CPA214284V5PKG	105	768.30	CPDS24H6	107	77.20
CMBPSPHD		Discontinued	CPA214864V4	104	652.75	CPFE14		Discontinued
CMBPTH2		Discontinued	CPA214872V4	104	655.05	CPFE18		Discontinued
CMBPTH2HD		Discontinued	CPA214884V5PKG	105	807.30	CPFE21		Discontinued
CMBR	14	55.00	CPA215464V4	104	735.15	CPFE24		Discontinued
CP12	195	8.60	CPA215472V4	104	737.45	CPFL241		Discontinued
CP1210	26, 50, 53	73.00	CPA215484V5PKG	105	910.30	CPFL242		Discontinued
CP1220	26, 39, 50, 53	140.00	CPA216064V4	104	791.55	CPFL301		Discontinued
CP15	195	10.65	CPA216072V4	104	793.85	CPFL302		Discontinued
CP2632	32	72.00	CPA216084V5PKG	105	980.80	CPFL361		Discontinued
CP27	195	12.15	CPA217264V4PKG	104	904.15	CPFL362		Discontinued
CP3253	32	105.00	CPA217272V4PKG	104	906.45	CPFL421		Discontinued
CP814	26, 50, 53, 54	73.00	CPA217284V5PKG	105	1,121.55	CPFL422		Discontinued
CPA182464V4	104	385.85	CPA242464V4	104	429.75	CPFL481		Discontinued
CPA182472V4	104	388.30	CPA242472V4	104	432.35	CPFL482		Discontinued
CPA182484V5PKG	105	474.60	CPA242484V5PKG	105	528.60	CPFL541		Discontinued
CPA183064V4	104	450.85	CPA243064V4	104	506.55	CPFL542		Discontinued
CPA183072V4	104	453.30	CPA243072V4	104	509.15	CPFL601		Discontinued

ALPHA NUMERICAL LISTING

Discontinued items effective 1/1/2018

CODE	PAGE	PRICE	CODE	PAGE	PRICE	CODE	PAGE	PRICE
CPFL602		Discontinued	CPMCWB	108	70.05	CPTR362PK	110	55.90
CPFL721		Discontinued	CPMDB	108	9.30	CPTR42	110	29.05
CPFL722		Discontinued	CPMU183667V4	105	888.30	CPTR422PK	110	63.90
CPFWSC244860	109	2,950.00	CPMU183675V4	105	893.20	CPTR48	110	32.50
CPH3	46	73.00	CPMU184267V4	105	961.10	CPTR482PK	110	71.50
CPHU213667S4	114	901.00	CPMU184275V4	105	966.00	CPTR54	110	36.00
CPHU213667V4	114	878.00	CPMU184867V4	105	987.30	CPTR542PK	110	79.20
CPHU213675S4	114	906.00	CPMU184875V4	105	992.20	CPTR60	110	39.55
CPHU213675V4	114	883.00	CPMU213667V4	105	942.40	CPTR602PK	110	87.00
CPHU214267S4	114	985.40	CPMU213675DDPKG	111, 234	1,234.70	CPTR72	110	46.50
CPHU214267V4	114	960.80	CPMU213675V4	105	947.40	CPU182464V4	104	497.70
CPHU214275S4	114	990.40	CPMU214267V4	105	1,025.20	CPU182472V4	104	502.60
CPHU214275V4	114	965.80	CPMU214275V4	105	1,030.20	CPU182484V5PKG	105	606.70
CPHU214867S4	114	1,025.60	CPMU214867V4	105	1,056.40	CPU183064V4	104	562.70
CPHU214867V4	114	992.00	CPMU214875V4	105	1,061.40	CPU183072V4	104	567.60
CPHU214875S4	114	1,030.60	CPMU243667V4	105	960.10	CPU183084V5PKG	105	687.95
CPHU214875V4	114	997.00	CPMU243675V4	105	965.30	CPU183664V4	104	599.10
CPHU215467S4	114	1,109.40	CPMU244267V4	105	1,033.50	CPU183672V4	104	604.00
CPHU215467V4	114	1,074.40	CPMU244275V4	105	1,038.70	CPU183684V5PKG	105	733.45
CPHU215475S4	114	1,114.40	CPMU244867FXPKG	54	1,068.90	CPU184264V4	104	671.90
CPHU215475V4	114	1,079.40	CPMU244867SUPKG	109	3,751.20	CPU184272V4	104	676.80
CPHU216067S4	114	1,167.60	CPMU244867V4	105	1,082.30	CPU184284V5PKG	105	824.45
CPHU216067V4	114	1,130.80	CPMU244875DRPKG	110, 233	1,411.80	CPU184864V4	104	698.10
CPHU216075S4	114	1,172.60	CPMU244875PDPKG	111, 234	1,531.30	CPU184872V4	104	703.00
CPHU216075V4	114	1,135.80	CPMU244875V4	105	1,087.50	CPU184884V5PKG	105	857.20
CPHU243667S4	114	927.50	CPMU246075DRPKG	110, 233	1,626.30	CPU185464V4	104	770.30
CPHU243667V4	114	895.70	CPR14E	109	21.75	CPU185472V4	104	775.20
CPHU243675S4	114	932.70	CPR18E	109	23.50	CPU185484V5PKG	105	947.45
CPHU243675V4	114	900.90	CPR21E	109	24.80	CPU186064V4	104	819.90
CPHU244267S4	114	1,001.90	CPR2436	109	121.40	CPU186072V4	104	824.80
CPHU244267V4	114	969.10	CPR24363	109	86.90	CPU186084V5PKG	105	1,009.45
CPHU244275S4	114	1,007.10	CPR2442	109	129.30	CPU187264V4PKG	104	916.70
CPHU244275V4	114	974.30	CPR24423	109	90.85	CPU187272V4PKG	104	921.60
CPHU244867S4	114	1,054.30	CPR2448	109	135.20	CPU187284V5PKG	105	1,130.45
CPHU244867V4	114	1,017.90	CPR24483	109	93.80	CPU212464V4	104	536.50
CPHU244875S4	114	1,059.50	CPR24E	109	26.20	CPU212472V4	104	541.10
CPHU244875V4	114	1,023.10	CPR24S	109	28.70	CPU212484V5PKG	105	653.35
CPHU245467S4	114	1,129.50	CPR30S	109	31.55	CPU213064V4	104	610.10
CPHU245467V4	114	1,086.50	CPR36S	109	34.50	CPU213072V4	104	614.70
CPHU245475S4	114	1,134.70	CPR42S	109	38.45	CPU213084V5PKG	105	745.35
CPHU245475V4	114	1,091.70	CPR48S	109	41.40	CPU213664V4	104	653.50
CPHU246067S4	114	1,186.30	CPR54S	109	45.30	CPU213672V4	104	658.10
CPHU246067V4	114	1,137.30	CPR60S	109	48.20	CPU213684V5PKG	105	799.60
CPHU246075S4	114	1,191.50	CPR72S	109	55.10	CPU214264V4	104	736.30
CPHU246075V4	114	1,142.50	CPSK2448S1	54	149.65	CPU214272V4	104	740.90
CPL12	195	1.45	CPTR24	110	18.30	CPU214284V5PKG	105	903.10
CPL27	195	1.50	CPTR30	110	21.95	CPU214864V4	104	767.50
CPMCHD	115	53.95	CPTR36	110	25.40	CPU214872V4	104	772.10

ALPHA NUMERICAL LISTING

Discontinued items effective 1/1/2018

CODE	PAGE	PRICE	CODE	PAGE	PRICE	CODE	PAGE	PRICE
CPU214884V5PKG	105	942.10	CSID6	107, 124	2.25	DD1220CW	199	51.75
CPU215464V4	104	849.90	CSMHDDDB	124	10.70	DD1220ECW	199	65.40
CPU215472V4	104	854.50	CSMHDTK10	115	620.00	DD1220SCW	199	65.40
CPU215484V5PKG	105	1,045.10	CSMHDTK12	115	715.00	DD1826CW	199	72.60
CPU216064V4	104	906.30	CSMHDTK145	115	805.00	DG3CW	179	2.35
CPU216072V4	104	910.90	CSMHDTKE4	115	233.90	DIV12	29, 46, 53	4.20
CPU216084V5PKG	105	1,115.60	CSMHDTKE5	115	249.75	DIV20	46	10.05
CPU217264V4PKG	104	1,018.90	CSMHDTKE6	115	296.50	DP15	190	13.35
CPU217272V4PKG	104	1,023.50	CSR3	37	505.00	DRC2020	73, 232	55.55
CPU217284V5PKG	105	1,256.35	CSR5	37	525.00	DRLNK	137	2.40
CPU242464V4	104	545.30	CSSC244818	110, 126	640.00	DRS30	137	235.00
CPU242472V4	104	550.50	CSSD188	108, 125	17.00	DRS300	137	235.00
CPU242484V5PKG	105	664.45	CSSD218	108, 125	18.50	DRS36	137	255.00
CPU243064V4	104	622.10	CSSD248	108, 125	20.00	DRS360	137	255.00
CPU243072V4	104	627.30	CSTSR	109, 125	385.00	DRS48	137	305.00
CPU243084V5PKG	105	760.45	CSWF	107, 124, 135	25.00	DRS480	137	305.00
CPU243664V4	104	671.10	CSWS1436SK	136	152.40	DRS60	137	350.00
CPU243672V4	104	676.30	CSWS1436VK	136	152.40	DRS600	137	350.00
CPU243684V5PKG	105	821.70	CSWS1448SK	136	175.00	DSPR6	186	47.15
CPU244264V4	104	744.50	CSWS1448VK	136	175.00	DT1220CW	199	20.85
CPU244272V4	104	749.70	CSWS1836SK	136	175.00	E3	77, 232	13.75
CPU244284V5PKG	105	913.45	CSWS1848SK	136	191.90	EA182464V4	120	320.75
CPU244864SUPKG	109	3,462.20	CSWS36EK	136	211.15	EA182472V4	120	322.65
CPU244864SUPKG	109	3,462.20	CSWS48EK	136	314.15	EA182484V5	121	395.20
CPU244864V4	104	793.30	CVC55	52	3,760.00	EA183064V4	120	333.35
CPU244872V4	104	798.50	CVC72	52	6,280.00	EA183072V4	120	335.25
CPU244884V5PKG	105	974.45	CVC724	52	6,280.00	EA183084V5	121	410.95
CPU245464V4	104	861.90	D12	183	1.56	EA183664V4	120	374.75
CPU245472V4	104	867.10	D14	180, 183	1.93	EA183672V4	120	376.65
CPU245484V5PKG	105	1,060.20	D16	183	1.98	EA183684V5	121	462.70
CPU246064V4	104	912.70	D24	183	2.57	EA184264V4	120	431.15
CPU246072V4	104	917.90	D8	183	1.48	EA184272V4	120	433.05
CPU246084V5PKG	105	1,123.70	DB18263CW	170	49.25	EA184284V5	121	533.20
CPU247264V4PKG	104	1,033.90	DB18263P	170	39.40	EA184864V4	120	451.35
CPU247272V4PKG	104	1,039.10	DB18266CW	170	66.20	EA184872V4	120	453.25
CPU247284V5PKG	105	1,275.20	DBC1826CW	170	35.90	EA184884V5	121	558.45
CR12	82	305.00	DBC1826P	170	26.50	EA185464V4	120	507.35
CRPHDG2878	74, 232	27.15	DC10	190	15.60	EA185472V4	120	509.25
CSDBA	108	5.80	DC1225	85	1,150.00	EA185484V5	121	628.45
CSDBS	108	5.80	DC5	190	11.35	EA186064V4	120	545.75
CSDDC	111, 126, 234	45.00	DC575	85	1,085.00	EA186072V4	120	547.65
CSDDC5	111, 126, 234	225.00	DC700	85	1,085.00	EA186084V5	121	676.45
CSDR7	110, 127, 233	56.00	DC825	85	1,085.00	EA187264V4	120	620.75
CSDR73	110, 127, 233	168.00	DCC10	190	11.10	EA187272V4	120	622.65
CSDR8	110, 127, 234	45.00	DCC5	190	7.95	EA187284V5	121	770.20
CSDR84	110, 127, 234	180.00	DCS1125	85	1,090.00	EA212464V4	120	350.70
CSEQ3	108, 124, 135	33.00	DCS950	85	1,045.00	EA212472V4	120	352.55
CSID3	107, 124	2.25	DD1220BECW	199	79.65	EA212484V5	121	432.00

ALPHA NUMERICAL LISTING

Discontinued items effective 1/1/2018

CODE	PAGE	PRICE	CODE	PAGE	PRICE	CODE	PAGE	PRICE
EA213064V4	120	366.70	EDBA	125	4.40	EMU244878DRPKG	127	1,273.90
EA213072V4	120	368.55	EDBS	125	4.40	EMU244878DRPKG	233	1,273.90
EA213084V5	121	452.00	EDS14H10	123	55.90	EMU244878PDPKG	127	1,443.60
EA213664V4	120	414.70	EDS14H6	123	51.25	EMU244878PDPKG	234	1,443.60
EA213672V4	120	416.55	EDS18H10	123	57.55	EMU244878V4	121	873.00
EA213684V5	121	512.00	EDS18H6	123	52.90	EMU245470V4	121	901.80
EA214264V4	120	478.30	EDS21H10	123	58.95	EMU245478V4	121	905.60
EA214272V4	120	480.15	EDS21H6	123	54.30	EMU246070V4	121	941.40
EA214284V5	121	591.50	EDS24H10	123	60.25	EMU246078DRPKG	127	1,441.90
EA214864V4	120	502.70	EDS24H6	123	55.60	EMU246078DRPKG	233	1,441.90
EA214872V4	120	504.55	EMCWB	124	56.65	EMU246078V4	121	945.20
EA214884V5	121	622.00	EMSK2448S1	54	122.65	EPP160	32	90.00
EA215464V4	120	566.50	EMTR36	126	33.50	EPP180	32	108.00
EA215472V4	120	568.35	EMTR362PK	126	67.00	EPP180S	32	108.00
EA215484V5	121	701.75	EMTR42	126	36.30	EPP260	32	65.00
EA216064V4	120	610.30	EMTR422PK	126	72.60	EPP280	32	72.00
EA216072V4	120	612.15	EMTR48	126	39.10	EPP300	32	375.00
EA216084V5	121	756.50	EMTR482PK	126	78.20	EPP3253DIV	32	35.00
EA217264V4	120	697.50	EMTR54	126	41.85	EPP400	32	432.00
EA217272V4	120	699.35	EMTR542PK	126	83.70	EPPID5	32	6.80
EA217284V5	121	865.50	EMTR60	126	44.65	ES28	51	1,355.00
EA242464V4	120	361.00	EMTR602PK	126	89.30	ES28RL	51	1,805.00
EA242472V4	120	362.90	EMU183670V4	121	719.30	ESR14E	125	21.75
EA242484V5	121	444.75	EMU183678V4	121	723.10	ESR18E	125	23.50
EA243064V4	120	385.80	EMU184270V4	121	775.50	ESR21E	125	24.80
EA243072V4	120	387.70	EMU184278V4	121	779.30	ESR2436	125	121.40
EA243084V5	121	475.75	EMU184870V4	121	795.90	ESR24363	125	86.90
EA243664V4	120	427.60	EMU184878V4	121	799.70	ESR2442	125	129.30
EA243672V4	120	429.50	EMU185470V4	121	830.90	ESR24423	125	90.85
EA243684V5	121	528.00	EMU185478V4	121	834.70	ESR2448	125	135.20
EA244264V4	120	484.60	EMU186070V4	121	869.50	ESR24483	125	93.80
EA244272V4	120	486.50	EMU186078V4	121	873.30	ESR24E	125	26.20
EA244284V5	121	599.25	EMU213670V4	121	761.20	ESR24S	125	28.70
EA244864V4	120	522.00	EMU213678V4	121	764.80	ESR30S	125	31.55
EA244872V4	120	523.90	EMU214270V4	121	825.00	ESR36S	125	34.50
EA244884V5	121	646.00	EMU214278V4	121	828.60	ESR42S	125	38.45
EA245464V4	120	575.20	EMU214870V4	121	849.40	ESR48S	125	41.40
EA245472V4	120	577.10	EMU214878V4	121	853.00	ESR54S	125	45.30
EA245484V5	121	712.50	EMU215470V4	121	892.40	ESR60S	125	48.20
EA246064V4	120	614.80	EMU215478V4	121	896.00	ESR72S	125	55.10
EA246072V4	120	616.70	EMU216070V4	121	936.00	ESU182464V4	120	404.90
EA246084V5	121	762.00	EMU216078V4	121	939.60	ESU182472V4	120	408.70
EA247264V4	120	708.40	EMU243670V4	121	775.00	ESU182484V5	121	494.65
EA247272V4	120	710.30	EMU243678V4	121	778.80	ESU183064V4	120	417.50
EA247284V5	121	879.00	EMU244270V4	121	831.80	ESU183072V4	120	421.30
ECC1	123	5.80	EMU244278V4	121	835.60	ESU183084V5	121	510.40
ECC10	123	58.00	EMU244870FXPKG	54	932.20	ESU183664V4	120	458.90
ECC8	123	46.40	EMU244870V4	121	869.20	ESU183672V4	120	462.70

ALPHA NUMERICAL LISTING

Discontinued items effective 1/1/2018

CODE	PAGE	PRICE	CODE	PAGE	PRICE	CODE	PAGE	PRICE
ESU183684V5	121	562.15	ESU243684V5	121	630.25	HT120CW	180, 182	2.94
ESU184264V4	120	515.30	ESU244264V4	120	571.60	HT12CW	182	2.88
ESU184272V4	120	519.10	ESU244272V4	120	575.40	HT14CW	182	3.23
ESU184284V5	121	632.65	ESU244284V5	121	701.50	HT16CW	180, 182	3.76
ESU184864V4	120	535.50	ESU244864V4	120	609.00	HT22CW	180, 182	4.70
ESU184872V4	120	539.30	ESU244872V4	120	612.80	HT5CW	182	2.58
ESU184884V5	121	657.90	ESU244884V5	121	748.25	HT8CW	180, 182	2.70
ESU185464V4	120	591.50	ESU245464V4	120	662.20	HWAPR	38	275.00
ESU185472V4	120	595.30	ESU245472V4	120	666.00	HWATD	38	360.00
ESU185484V5	121	727.90	ESU245484V5	121	814.75	IB32	171	415.00
ESU186064V4	120	629.90	ESU246064V4	120	701.80	IB36	171	425.00
ESU186072V4	120	633.70	ESU246072V4	120	705.60	IB44	171	430.00
ESU186084V5	121	775.90	ESU246084V5	121	864.25	IBS20	171	375.00
ESU187264V4	120	704.90	ESU247264V4	120	795.40	IBS27	171	385.00
ESU187272V4	120	708.70	ESU247272V4	120	799.20	IBS37	171	425.00
ESU187284V5	121	869.65	ESU247284V5	121	981.25	IBSD37	171	566.67
ESU212464V4	120	437.00	ETR24	126	24.90	IBSF27	171	400.00
ESU212472V4	120	440.70	ETR30	126	27.00	ICS100L	64	1,040.00
ESU212484V5	121	533.50	ETR36	126	28.05	ICS100L4S	64	1,070.00
ESU213064V4	120	453.00	ETR362PK	126	56.10	ICS125L	64	1,065.00
ESU213072V4	120	456.70	ETR42	126	29.95	ICS125LB	64	1,140.00
ESU213084V5	121	553.50	ETR422PK	126	59.90	ICS125T	64	1,130.00
ESU213664V4	120	501.00	ETR48	126	32.65	ICS175L	64	1,265.00
ESU213672V4	120	504.70	ETR482PK	126	65.30	ICS175LB	64	1,320.00
ESU213684V5	121	613.50	ETR54	126	35.45	ICS175T	64	1,330.00
ESU214264V4	120	564.60	ETR542PK	126	70.90	ICS175TB	64	1,415.00
ESU214272V4	120	568.30	ETR60	126	38.20	ICS200TB	64	1,450.00
ESU214284V5	121	693.00	ETR602PK	126	76.40	KK1200	72	16.35
ESU214864V4	120	589.00	ETR72	126	43.70	KSC402	51	5,565.00
ESU214872V4	120	592.70	FR258	75	40.05	KVC854	50	7,660.00
ESU214884V5	121	723.50	FSG480	47	395.00	KVC854C	50	10,450.00
ESU215464V4	120	652.80	FSG720	47	505.00	KVC856	50	7,660.00
ESU215472V4	120	656.50	FWC56	75, 82	4.65	KVC856C	50	10,450.00
ESU215484V5	121	803.25	GB1200CW	179	4.90	KWS40	51	2,670.00
ESU216064V4	120	696.60	GB850CW	179	4.15	LCDCH	38	89.00
ESU216072V4	120	700.30	GK2000	72	17.40	LCDCH10	38	130.00
ESU216084V5	121	858.00	HBR258	74, 76	25.15	LCDES	38	17.05
ESU217264V4	120	783.80	HBR414	74	40.50	LD105	195	3.30
ESU217272V4	120	787.50	HBR578	74	52.20	LD105A	195	4.75
ESU217284V5	121	967.00	HBR712	74	64.25	LD130	195	3.70
ESU242464V4	120	448.00	HE3	77	12.15	LD85	195	3.30
ESU242472V4	120	451.80	HFR258	75	34.55	LD85A	195	4.75
ESU242484V5	121	547.00	HK39	177	29.60	LDT10	180, 181	2.15
ESU243064V4	120	472.80	HK39B	229	10.65	LDT12	180, 181	2.17
ESU243072V4	120	476.60	HK93BCW	177	15.70	LDT16	180, 181	2.60
ESU243084V5	121	578.00	HK93CW	177	28.95	LDT22	180, 181	3.21
ESU243664V4	120	514.60	HP3253	32	142.00	LDT5	180, 181	1.69
ESU243672V4	120	518.40	HT10CW	182	2.81	LDT6	180, 181	1.84

ALPHA NUMERICAL LISTING

Discontinued items effective 1/1/2018

CODE	PAGE	PRICE	CODE	PAGE	PRICE	CODE	PAGE	PRICE
LDT9	180, 181	2.13	OETR314	75	39.20	PT1100	213	10.65
LED54LIGHTPKG	46	480.00	P320CW	178	10.70	PT1216	213	14.90
LT10	180, 183	2.18	P480CW	178	12.90	PT1400	213	14.25
LT12	180, 183	2.39	P600CW	178	13.65	PT1418	213	18.90
LT14	183	2.53	P60CW	178	15.75	PT1600	213	19.25
LT16	180	2.80	P64CW	178	15.75	PWB22	38, 186	27.55
LT22	183	3.15	PC34CW	178	9.50	R1000LCD	38	110.00
LT6	180, 183	1.93	PC64CW	178	20.25	R500LCD	38	99.00
LT8	180, 183	2.11	PCMC	9	2,766.00	RD1200CW	199	29.95
MDC1411T60	239	6,175.00	PCMC2	9	2,766.00	RD1220CW	199	54.75
MDC1418S20	237	3,820.00	PCMH	9	1,622.00	RD1220CWH	199	77.90
MDC1418T16	238	3,495.00	PCMH2	9	1,622.00	RD1826CW	199	70.95
MDC1418T30	238	6,175.00	PCUCC	9	12,585.00	RD1826CWH	199	82.80
MDC1520S10	236	2,585.00	PCUCC2	9	12,585.00	RD926CW	199	48.20
MDC1520S10D	235	3,540.00	PCUCH	9	11,440.00	RFS1	149	4.30
MDC1520S10HD	236	3,020.00	PCUCH2	9	11,440.00	RFS12	149	15.50
MDC1520S20	237	3,885.00	PCUHC	9	11,440.00	RFS12PP	149	16.50
MDC1520T16	238	3,585.00	PCUHC2	9	11,440.00	RFS12SCPP	148	7.30
MDC1520T30	238	6,235.00	PCUHH	9	8,060.00	RFS18	149	18.80
MDC24	39	2,575.00	PCUHH2	9	8,060.00	RFS18PP	149	20.00
MDC24F	39	2,575.00	PCULC	9	7,200.00	RFS1PP	149	4.45
MDC24R	39	145.00	PCULC2	9	7,200.00	RFS1SCPP	148	2.15
MDCPC9CW	175	8.75	PCULH	9	5,200.00	RFS2	149	4.65
MDSB16	227	5.85	PCULH2	9	5,200.00	RFS22	149	22.15
MDSB5	227	3.00	PCULP	11	3,800.00	RFS22PP	149	23.50
MDSB9	227	3.00	PCUPC	9	8,405.00	RFS2PP	149	4.95
MDSDCB9	229	95.00	PCUPC2	9	8,405.00	RFS2SCPP	148	3.30
MDSDCB9X1	231	8,500.00	PCUPH	9	7,260.00	RFS4	149	5.30
MDS09	229	18.55	PCUPH2	9	7,260.00	RFS4PP	149	5.75
MDSHB5	226	3.00	PCUPP	11	6,035.00	RFS6	149	6.60
MDSHB9	226	3.00	PE600CW	178	9.35	RFS6PP	149	6.95
MDSHD9	226	18.55	PL60CW	178	9.35	RFS6SCPP	148	3.40
MDSHM8	226	3.00	PPB15	187	74.40	RFS8	149	8.65
MDSL9	229	8.40	PPB18	187	98.15	RFS8PP	149	9.25
MDSL09	229	14.00	PPB23	187	168.85	RFSC1	149	1.45
MDSM8	227	3.00	PR314	75	40.05	RFSC12	149, 186	5.15
MDSP9	229	43.35	PR500	75, 232	56.90	RFSC12PP	149	5.65
MDSPC9	229	30.00	PR59314	75	40.05	RFSC1PP	149	1.65
MDSPL	229	81.90	PR59500	75	56.90	RFSC2	149	1.50
MDSPLT9	229	189.00	PS1014	217	6.45	RFSC2PP	149	1.70
NT10	180, 182	1.90	PSB10	192	11.95	RFSC6	149	2.15
NT12	180, 182	1.97	PSB12	192	15.45	RFSC6PP	149	2.45
NT14	182	2.29	PSB15	193	25.15	RFSCW1	148	6.65
NT16	182	2.36	PSB18	193	40.05	RFSCW12	148	32.55
NT20	180, 182	2.92	PSB23	193	61.00	RFSCW18	148	44.65
NT5	180, 182	1.54	PSB6	192	3.55	RFSCW2	148	9.20
NT8	180, 182	1.60	PSB8	192	6.05	RFSCW22	148	51.40
NT9	180, 182	1.74	PT1014	213	13.70	RFSCW4	148	15.55

ALPHA NUMERICAL LISTING

Discontinued items effective 1/1/2018

CODE	PAGE	PRICE	CODE	PAGE	PRICE	CODE	PAGE	PRICE
RFSCW6	148	18.20	SPA14	196	12.25	UPCGL1600SP	19	2,860.00
RFSCW8	148	23.05	SPASL14	196	12.25	UPCH1600	17	5,875.00
RFSCWC1	148	2.40	SPO10CW	196	2.85	UPCH16002	17	5,875.00
RFSCWC12	148	12.45	SPO11CW	196	3.50	UPCH16002HD	17	6,040.00
RFSCWC2	148	4.30	SPO13	196	10.90	UPCH16002SP	17	6,055.00
RFSCWC6	148	5.45	SPO13CW	196	6.00	UPCH1600HD	17	6,040.00
RSB1014CW	193	18.50	SPO8CW	196	2.60	UPCH1600SP	17	6,055.00
RSB10CW	193	16.20	SPOP10CW	196	2.85	UPCH400	17	1,475.00
RSB12CW	193	27.00	SPOP11CW	196	3.50	UPCH4002	17	1,475.00
RSB1419CW	193	30.00	SPOP13	196	10.90	UPCH800	17	3,625.00
RSB15CW	193	34.90	SPOP13CW	196	6.00	UPCH8002	17	3,625.00
RSB18CW	193	50.25	SRB13	186	3.55	UPCHT1600	17	4,575.00
RSB23CW	193	75.70	SRB13CW	186	4.45	UPCHT16002	17	4,575.00
RSB6CW	193	4.55	SRB5	186	1.90	UPCHT16002HD	17	4,740.00
RSB8CW	193	8.85	SRB5CW	186	2.25	UPCHT1600HD	17	4,740.00
RSB912CW	193	12.65	SSR1	9, 11	82.00	UPCHT800	17	2,760.00
SB55	194	1.90	SSR8	9, 11	595.00	UPCHT8002	17	2,760.00
SB60	194	2.30	TC1418	82	1,220.00	UPCHW400	17	1,675.00
SB80	194	4.65	TDC2029	82	1,085.00	UPCHW4002	17	1,675.00
SBH15	46	73.00	TDC30	85	1,420.00	UPCS140	29	270.00
SBH18	46	73.00	TDCR12	82	1,425.00	UPCS160	29	280.00
SCP12CW	172	7.25	TG6	197	2.45	UPCS180	29	300.00
SCP24CW	172	9.20	TG9	197	3.90	UPCS400	23	535.00
SCP64CW	172	13.10	TGA11	197	4.50	UPCS400CK	23	139.05
SCP6CW	172	6.70	TGA8	197	3.85	UPCSS160		Discontinued
SFC12	145	6.50	TGG6	197	3.85	UTHSTP	41	17.00
SFC12SCPP	144	6.50	TGG9	197	4.15	VBR5	45	3,275.00
SFC12SCPP441	173	6.90	UC1000	37	440.00	VBR6	45	3,410.00
SFC2	145	3.60	UC1000CVR	37	130.00	VBRC	45	180.00
SFC2SCPP	144	3.60	UC250	37	290.00	VBRC90	45	310.00
SFC2SCPP441	173	3.80	UC250CVR	37	130.00	VBRCVR5	46	310.00
SFC6	145	4.45	UC500	37	325.00	VBRCVR6	46	340.00
SFC6SCPP	144	4.45	UC500CVR	37	130.00	VBRHD5	45	3,510.00
SFC6SCPP441	173	4.75	UPC100	29	455.00	VBRHD6	45	3,650.00
SFG1012	191	17.60	UPC1200	19	1,970.00	VBRL5	45	3,275.00
SFG1015	191	18.75	UPC140	29	405.00	VBRL6	45	3,410.00
SFG1220	191	23.95	UPC160	29	410.00	VBRLHD5	45	3,510.00
SFG820	191	19.95	UPC1600	19	2,835.00	VBRLHD6	45	3,650.00
SFR1012	191	17.60	UPC1600HD	19	2,985.00	VBRR5	46	435.00
SFT1010	191	16.65	UPC1600SP	19	3,095.00	VBRR6	46	465.00
SFT1212	191	18.00	UPC180	29	420.00	VBRSHTS	46	265.00
SFT1515	191	20.90	UPC300	24	505.00	VBRT5	45	2,415.00
SFV1015	191	18.30	UPC300DIV	26	78.00	VBRT6	45	2,555.00
SLL30	154	180.25	UPC400	22	595.00	VBRTBL	46	470.00
SMBPHSP		Discontinued	UPC400SP	22	660.00	VBRTCVR5	46	165.00
SMBPHSPHD		Discontinued	UPC600	19	1,280.00	VBRTCVR6	46	180.00
SMBPTHSP		Discontinued	UPC800	19	1,515.00	VBRTHD5	45	2,655.00
SMBPTHSPHD		Discontinued	UPC800SP	19	1,630.00	VBRTHD6	45	2,795.00

CODE	PAGE	PRICE
VBRTL5	45	2,310.00
VBRTL6	45	2,450.00
VBRTLHD5	45	2,550.00
VBRTLHD6	45	2,690.00
VBRU5	45	4,175.00
VBRU6	45	4,460.00
VBRUHD5	45	4,410.00
VBRUHD6	45	4,700.00
VBRUT5	45	2,825.00
VBRUT6	45	2,950.00
VBRUTHD5	45	3,065.00

CODE	PAGE	PRICE
VBRUTHD6	45	3,190.00
VBRWC	46	135.00
VCS	45	2,465.00
VCS32CNT	45	320.00
VCS32KEYT	46	104.00
VCS32R	46	360.00
VCSCNL	45	390.00
VCSCVR	46	165.00
VCSHD	45	2,715.00
VCSWR	45	2,535.00
VCSWRHD	45	3,195.00

CODE	PAGE	PRICE
WC100CW	187	40.95
WC100CWNH	187	23.55
WCR1220	50, 53	105.00
WW1000	185	10.45
WW1000L	185	0.95
WW1000LS	185	0.95
WW1500	185	13.60
WW250	185	4.65
WW250L	185	0.95
WW500	185	7.70

General Terms

Cambro products may be combined to obtain prepaid freight.

Specifications, features and equipment shown are based upon the latest information available. Cambro Manufacturing Company reserves the right to make changes at any time, without notice, to price, colors, specifications, accessories and materials. For additional information, please contact your authorized Cambro representative.

Freight

Freight is free on shipments totaling \$3,500 net or more, based on a single order for single delivery within the continental U.S.A. Orders for shipments totaling less than \$3,500 are F.O.B. Any items back ordered from a "free freight order" will be forwarded transportation charges paid. Add-ons are not allowed on "free freight order backorders". Customer requested palletized orders will be charged \$7.00 net per pallet.

Return Merchandise Policy

No merchandise may be returned without written authorization. Authorized returns must be shipped freight prepaid. All returned goods must be new and unused, in original packaging and are subject to a minimum 15% repackaging charge plus outbound freight. Return of goods must be requested within 60 days of invoice. Special or non-standard items are not returnable.

Assessorial Charges

From time to time, motor carriers will charge for services that are beyond the scope of a normal delivery. In the event that this happens, Cambro Mfg. reserves the right to bill the customer for these charges. Services that fall under this program would include:

- Sort & Segregation of product at customer's dock.
- Lift-gate required to off load the product from the truck.
- Inside delivery requests.

These charges are considered to be assessorial charges and are not included in the prepaid freight program.

Broken Cartons

Orders calling for less than standard pack will be charged \$10.00 net per broken case. Broken cartons are not available on any special order items, the assortment pack, custom imprinted ladles, 4 pack booster chairs, disposable lids or on StoreSafe labels. **There is no broken carton charge on Camracks.**

Replacement Parts

Visit www.cambro.com for replacement parts information on Cambro products.

Product Accessories

Contents and accessories shown in photos are not included, except where noted.

Cambro® Warranty

Cambro offers a 5-year pro-rated warranty against damage or manufacturer's defects found in excess to normal wear and tear on our Camtrays®, Camtread® trays and Dinnerware. Commercial Electrical Equipment models hold a 1-year warranty. Non-Skid Versa Camtrays, Tongs, Camwear® Food Storage Pans, all high heat material products, Squares, Rounds and Lids have a 2-year pro-rated warranty. All Camshelving® Series have a 1-year warranty on workmanship and a lifetime limited warranty against rust and corrosion, excluding mobile posts. For all other Cambro products, Cambro warrants to the original buyer a 3-year pro-rated warranty unless otherwise noted. If product proves defective during this time, Cambro grants a pro-rated credit of the original price toward replacement product. The warranty applies on all Cambro products only when used under normal foodservice industry conditions.

Note: Temperature ranges noted throughout this catalog are based on specific test criteria and provide a general guideline. Individual use may vary due to differences in loading temperatures or ambient temperature.

STEMWARE AND GLASS SIZING REFERENCE GUIDE

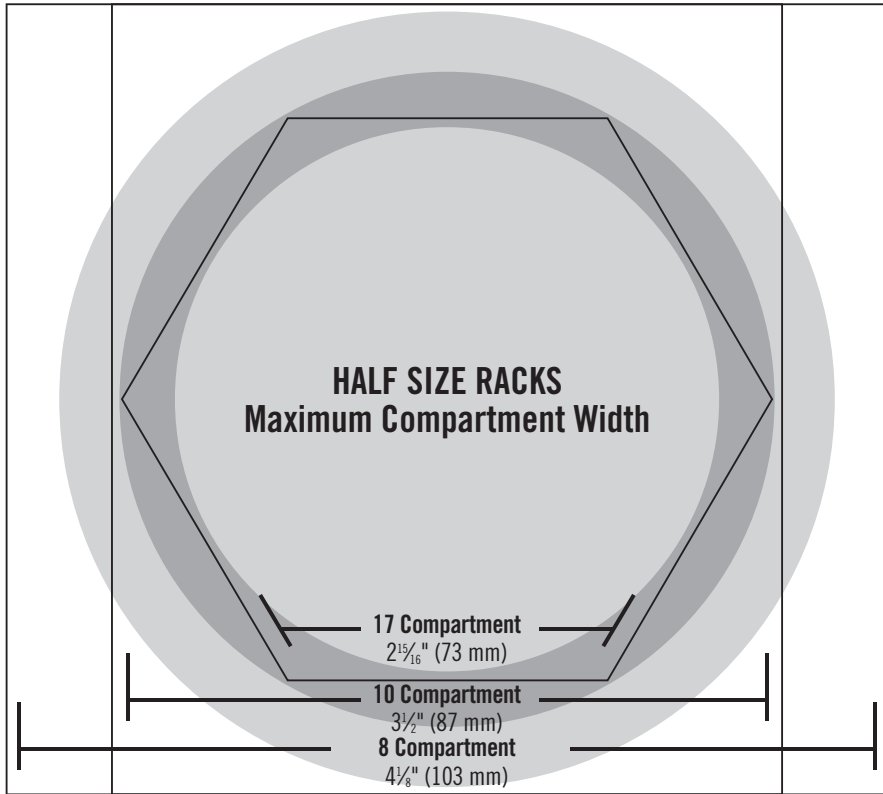

To Determine Compartment Size

- **Half Size Racks:** Place glass or stemware upside down over circle chart. Look down on the glass. Whatever circle the largest diameter of the glass fits within will determine the number of compartments.
- **Full Size Racks:** Place glass or stemware upside down over circle chart. Look down on the glass. Whatever circle the largest diameter of the glass fits within will determine the number of compartments.

Use the vertical guide marks at right to determine item height and appropriate rack number.

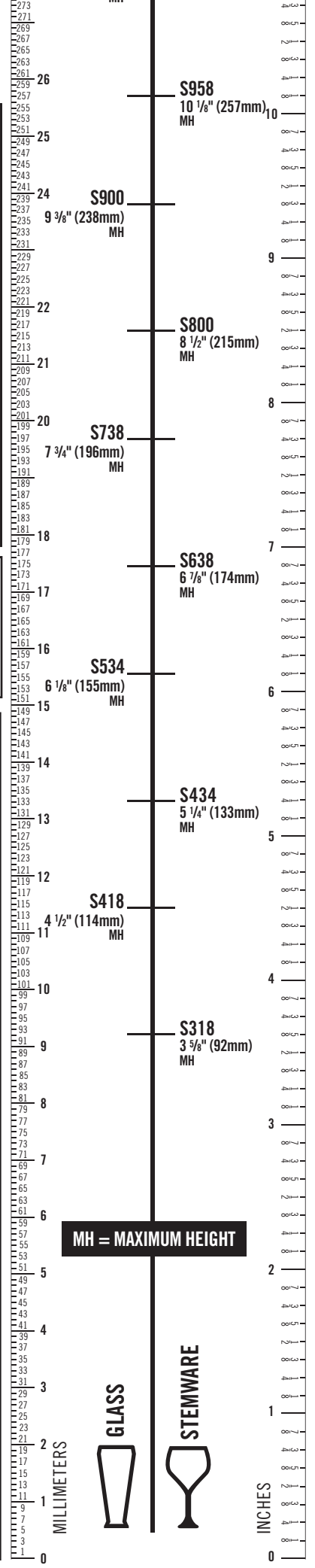
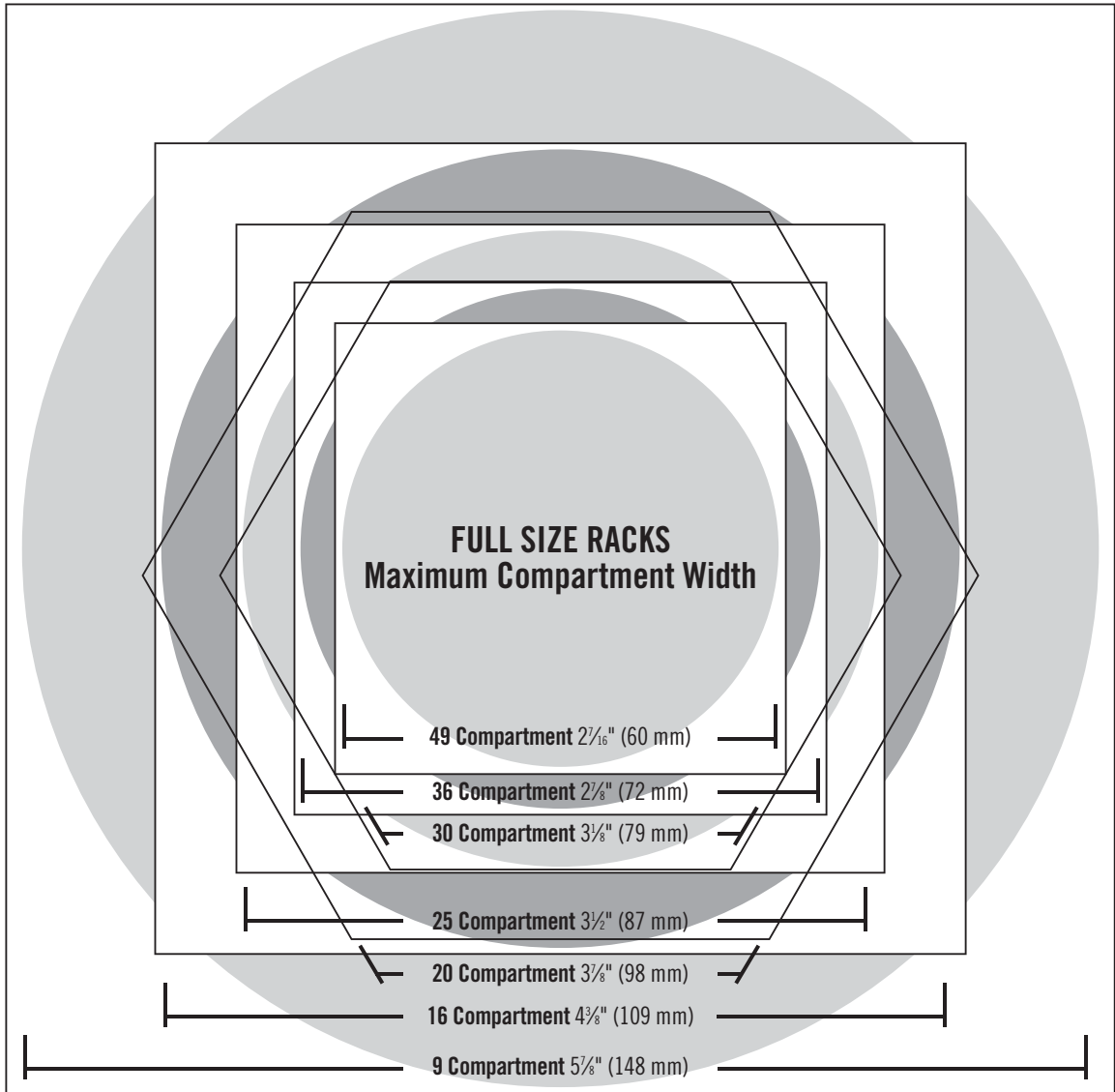

CAMRACK® CUP RACK REFERENCE GUIDE



16

FULL RACK

COMPARTMENT

4³/₈" x 3¹/₂" (11,1 x 8 cm)

To determine Cup compartment size:
Turn cup or coffee mug upside down and place diagonally in square. Align handle with arrow in square. Cup or mug and handle must fit completely within boundaries of a square in order to ensure the right rack.



20

FULL RACK

QUICK GUIDE

Full Size Cup Racks (C)

Maximum Cup Width	Number of Compartments	Maximum Cup Height		
		2 ⁵ / ₈ " (6,6 cm)	4 ¹ / ₄ " (10,7 cm)	5 ⁷ / ₈ " (14,9 cm)
4 ³ / ₈ " (11,1 cm)	16	16C258	16C414	16C578
3 ¹ / ₂ " (8,8 cm)	20	20C258	20C414	20C578



10

HALF RACK

COMPARTMENT

4¹/₈" x 3¹/₂" (10,4 x 8,8 cm)



8

HALF RACK

COMPARTMENT

4⁷/₁₆" x 4¹/₈" (11,3 x 10,4 cm)

QUICK GUIDE

Half Size Cup Racks (HC)

Maximum Cup Width	Number of Compartments	Maximum Cup Height	
		2 ⁵ / ₈ " (6,6 cm)	4 ¹ / ₄ " (10,7 cm)
4 ¹ / ₈ " (10,4 cm)	8	8HC258	8HC414
3 ¹ / ₂ " (8,8 cm)	10	10HC258	10HC414

To Determine Cup Height:

Place base of cup or coffee mug on flat surface hold ruler vertically next to it to determine height in inches or millimeters. If the height is greater than 4¹/₄" (108 mm), additional 1⁵/₈" (41 mm) E2 and HE2 extenders may be ordered.

CAMBRO® EQUIPMENT COLOR CHART



Gray (180)



Coffee Beige (157)



Hot Red (158)

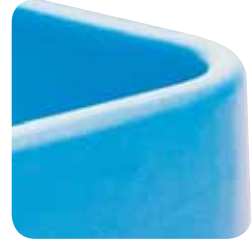

Cold Blue (159)



Speckled Gray (480)



Dark Taupe (417)



Brick Red (402)



Navy Blue (186)



Granite Gray (191)



Granite Sand (194)

Cambro provides a wide selection of colors to help you coordinate with your decor and color code items to simplify use. Color selections vary by product. Please see individual products for specific colors offered.



Slate Blue (401)



Charcoal Gray (615)



Dark Brown (131)

Due to the catalog printing process, the colors shown may not be exact. For exact colors, contact Cambro or a Cambro representative for a color chip.



Granite Green (192)



Black (110)



Kentucky Green (519)



CAMBRO U.S.A.
 5801 Skylab Road, Huntington Beach, CA 92647 P.O. Box 2000, Huntington Beach, CA 92647-2000
Telephone: (714) 848-1555 **Toll Free:** (800) 854-7631 **FAX:** (714) 842-3430
Customer Service: (800) 833-3003
 © Cambro Manufacturing Company. Printed in the U.S.A.
CAT2018/19US All prices are in US dollars. All prices are subject to change without prior notice.



For a Complete List of U.S.A. and International Representatives Please Visit www.cambro.com

NEW FROM CAMBRO®



Pro Cart Ultra™
5



1318CC Combo Carrier
21



UPC300 Ultra Pan Carrier® 24
 UPC300DIV ThermoBarrier® 26



Cam GoBox® Insulated
 Lightweight Carrier 30



Camshelving® Flex Station
54



Camshelving Shelf Rails 109, 125
 Camshelving Basics Plus 128



1/9 Size 6" Depth Camwear® and
 High Heat Food Pan 157, 163



X-Pan® High Heat Food Pans
160



H-pan™ with Handles
166



Translucent Colander Pans
167



Soak & Brine Tank
171



Camwear Low Profile Camcover®
175



EpicTread™ Trays
211



Camwear Non-Skid Tray with Handles
225



Harbor Collection Meal Delivery System
226



Camchiller® Pellet
229



10-Tray Dual Access Room Service Cart
235



Airpot and Condiment Station
236